

**THE IMPLEMENTATION  
OF UHF RADIO COMMUNICATIONS  
AND CCTV MONITORING SYSTEMS IN A  
ROOM AND PILLAR METAL/NON-METAL MINE  
FINAL REPORT**

**Prepared For:  
Bureau of Mines  
United States Department of the Interior**

**Contract No.: JO 377044**

**March 1981**

**COMSUL LTD.  
SAN FRANCISCO, CALIFORNIA**

**The views and conclusions contained in this document are those of the authors and should not be interpreted as necessarily representing the official policies or recommendations of the Interior Department's Bureau of Mines or of the U.S. Government.**

**Reference to specific brands, equipment, or trade-names in this report is made to facilitate understanding and does not imply endorsement by the Bureau of Mines.**

1. Report No.	2.	3. Recipient's Accession No.	
4. Title and Subtitle THE IMPLEMENTATION OF UHF RADIO COMMUNICATION AND CCTV MONITORING SYSTEMS IN A ROOM AND PILLAR METAL/ NON-METAL MINE		5. Report Date March 1981	6.
7. Author(s) R.A. Isberg, P.E., H. Kramer, D.A. Parrish		8. Performing Organization Report No.	
9. Performing Organization Name and Address Comsul Ltd. 417 Montgomery Street San Francisco, California 94104		10. Project/Task/Work Unit No.	
		11. Contract or Grant No. J0377044	
12. Sponsoring Organization Name and Address United States Department of the Interior Bureau of Mines, Pittsburgh Research Center Cochran's Mill Road, P.O. Box 18070 Pittsburgh, Pennsylvania 15236		13. Type of Report Final Report	
		14.	
15. Supplementary Notes Bureau of Mines Technical Project Officer, James C. Cawley			
16. Abstract This report describes the design and implementation of UHF radio and closed-circuit television systems in the Black River room and pillar limestone mine near Butler, Pendleton County, Kentucky. Prior to designing the radio system, measurements of signal attenuation on 812 and 466 mHz were made in the slope tunnel and in the straight and level crosscuts in the mine. Two distributed antenna systems fed by two sets of base stations provide approximately 75% coverage of the mine. Passive reflectors are used for extending signals into intersecting crosscuts and two-way signal boosters will be used to extend signals to the perimeter and obstructed areas of the mine. Fourteen mine vehicles were equipped with mobile radios equipped with digital identification, alarm and status encoders. Fifteen portable transceivers also were used. Six closed-circuit television cameras provide surveillance of critical transfer points of the belt conveyor system, and the loading dock at the base of the slope and an ash disposal area in the mine. Two-way radio communication and closed-circuit television have saved considerable man hours, increased production, reduced maintenance costs and enhanced safety.  Innovative developments were the use of passive reflectors and two-way signal boosters for extending signals into intersecting crosscuts, development of lightweight signal margin measuring equipment, modifications of mobile digital encoders to automatically send status information from mine vehicles such as numbers of loads of ore delivered, hot engine, etc., and the use of CATV technology for multiplexing audio, digital and video signals onto coaxial cables from the surface to the mine.			
17. Originator's Key Words UHF Radio System, Mine Communications Distributed Antenna System, Passive Reflectors, Signal Margin Measurements, Two-Way Signal Booster, Closed Circuit TV Systems for Mines		18. Availability Statement	
19. U. S. Security Classif. of the Report Unclassified	20. U. S. Security Classif. of This Page Unclassified	21. No. of Pages 121	22. Price

## FOREWORD

This report was prepared by Comsul Ltd., 417 Montgomery Street, San Francisco, California 94104 under USBM Contract Number J0377044. The contract was initiated under the Minerals Health & Safety Research Program. It was administered under the technical direction of the Pittsburgh Research Center with Mr. James C. Cawley acting as Technical Project Officer. Mr. Wm. R. Mundorf was the contract administrator for the Bureau of Mines. This report is a summary of the work recently completed as part of this contract during the period of October 1977 to March 1981. This report was submitted by the authors on March 31, 1981.

We wish to express our appreciation to Mr. Ken Reiser, General Manager; Mr. Al Cigallio, Construction and Development Manager; Mr. Bob Kuehneman, Underground Operations Superintendent; Mr. Dick Wehrmeyer, Electrical Engineer; Mr. Benny Whitmer, Safety Director; Mr. Tim Ellenberger, Mine Engineer; and Ms. Candy Frey, Secretary/Receptionist, of the Black River Mine.

Our special thanks and commendation to Mr. Jerry L. Bentz of Motorola Communications and Electronics, Inc., who has been Project Leader and who has contributed innovative features in the installation and modification of equipment. We also wish to thank Mr. M. W. Anesetti, Mr. Joseph Rupe, Mr. Ned Mountain, and Mr. Fred Beard of Motorola Communications and Electronics, Inc., for their contributions to the project.

## TABLE OF CONTENTS

	PAGE
FOREWORD .....	2
EXECUTIVE SUMMARY.....	11
1.0 INTRODUCTION AND BACKGROUND	
1.1 Introduction, Objective and Scope of Project.....	19
1.2 Selection of the Black River Mine and Comsul Ltd. for Demonstrating UHF Radio and CCTV Systems.....	20
2.0 ENGINEERING TESTS PRIOR TO DESIGNING THE RADIO SYSTEM	
2.1 Preliminary Qualitative Signal Propagation Tests.....	23
2.2 Evaluation of Test Results and Proposed Solutions of Problems.....	25
2.3 Investigation of Passive Reflectors and Distributed Antennas.....	25
2.4 Tests to Compare Communications on 812 and 466 MHz.....	27
2.5 Signal Strengths Measurements to Verify Reflector Performance .....	30
2.6 Measurements of Signal Attenuations Through the Slope Tunnel .....	30
2.7 Tests of Portable to Portable UHF Radio Communications Through the Air Shaft Emergency Exit .....	33
2.8 Design and Procurement of UHF Radio System .....	35
2.9 Design of Distributed Antenna and Passive Reflector Systems .....	43
3.0. CHRONOLOGICAL HISTORY OF INSTALLATION AND IMPLEMENTATION OF THE RADIO SYSTEM	
3.1 April - May 1979	
- Slope Car Communications.....	45
3.2 June 1979	
- Improvements in Slope Radio System, CCTV Survey and Preliminary Design of Monitoring Equipment .....	46
3.3 July - August 1979	
- Radio Installations in Vehicles and Development of Signal Margin Measuring Equipment .....	47
3.4 August 1979	
- Demonstration of Safe Operation of Radios Near Blasting Caps .....	53

TABLE OF CONTENTS (Continued)

	PAGE	
3.5	September 1979	
	- Inventory of Equipment and Improvements in Base Station Installations.....	53
3.6	October 1979	
	- Preliminary Design of Multiplexed Digital Alarms And Monitoring System.....	54
	- Preliminary Design of Uninterruptible Power System.....	55
	- Improvements in Sope Car Radio Installation.....	57
	- Preliminary Design of Interface Units for MODAT Encoders..	59
3.7	November 1979	
	- Radio Control and Alarm Center in the Mine Foreman's Office.....	60
3.8	December 1979	
	- A Project History was Issued to the BOM.....	61
3.9	- First CCTV Installation.....	61
	- Invention of Two Way UHF Signal Booster.....	61
3.10	February 1980	
	- Patent Disclosure for Signal Booster.....	63
3.11	March 1980	
	- Plans for Extending Antenna Systems with Signal Boosters..	63
	- Task Schedule for Installing Air Monitoring Tubing and for Completing Radio and CCTV Systems.....	63
3.12	April 1980	
	- New Project Manager was Appointed.....	63
	- Inventory of All Items Purchased.....	63
	- New Receiving Reports and Purchase Order Forms.....	63
3.13	May - June 1980	
	- Technical Acceptance Criteria Were Proposed.....	65
	- Prototype of Signal Booster was Constructed and Tested....	65
	- Monitoring and Radio Room was Installed Near Crusher No. 2.....	65
3.14	July 1980	
	- Conferences Held at Mine Regarding Progress.....	65
3.15	August 1980	
	- First MODAT Interface Unit Was Tested on a Mine Truck.....	65
	- Need for Water Tight Enclosures Recognized.....	65
	- CCTV Cameras were Installed at Base of Slope.....	67

TABLE OF CONTENTS (Continued)

	PAGE
3.16 September 1980	
- Completed Design of Multiplexing and UPS Systems For Air Quality Monitoring.....	67
- Redundant Coaxial Cable Installed In Bore Hole.....	67
- DC to DC Converters were Removed from Vehicles Due to Unreliability.....	67
- Research Continued on Signal Boosters and CATV Technology.....	67
3.17 October 1980	
- Fabrication of Six Signal Booster Began.....	69
- Transmission Lines for Extending the Antenna System were Completed.....	71
- TV Cameras were Repositioned at Base of Slope.....	71
3.18 November 1980	
- Results of Testing MODAT Interface Unit.....	71
- Improvements in Above Ground Radio Communications.....	71
3.19 December 1980	
- Need for TV Monitoring of the Ash Disposal Area in the Mine.....	73
- Radio Failure Due to Battery Problem on the Slope Car.....	73
3.20 January - February 1981	
- Emergency Alarm Annunciators for Office Building, Hoist House and Mine Shop Area.....	73
- Improvements in Sensors for Truck Bed Positions.....	73
- Adapting Radio Circuits to Mine Vehicle Power Systems.....	75
3.21 Inspection and Acceptance Tests of Radio and CCTV Systems...	77
- Signal Margin Measurements.....	77
3.22 As Built Radio System Description.....	80
- Radio Channel and Frequency Assignments.....	81
- Description of Distributed Antenna Systems.....	83
- Description of Control Stations.....	84
- Description of Mobile and Portable Radios.....	85
- Description of MODAT Identification, Alarm and Status System.....	85
- List of Vehicles and Personnel Equipped with Radios.....	86

TABLE OF CONTENTS (Continued)

	PAGE
3.22 (Continued)	
- Description of Control Consoles and Solutions to Operating in Noisy Locations.....	87
- Belling by Radio Arrangement in Slope Car.....	88
- Back Bone Control Cable System.....	83 & 88
3.23 As Built CCTV System Description.....	95
- List of Camera and Monitor Locations.....	95
- Advantages of CCTV to Enhance Safety and for Monitoring Conveyor Belt Operation.....	95
3.24 Research on the State of the Art of Underground Radio Communication.....	96
- Application of Two Way Signal Boosters, CATV Amplifiers and Intrinsically Safe Radio Systems.....	96
4.0 DEMONSTRATION OF SAFE OPERATION OF 450 MHz MOBILE AND PORTABLE RADIO TRANSMITTER ADJACENT TO A DRILLED ROCK FACE LOADED WITH BLASTING CAPS	
4.1 Background and Purpose of Demonstration.....	97
4.2 Procedures for Conducting the Demonstration.....	97
4.3 Test Results.....	99
4.4 Computations of the Amount of Radio Energy That is Available Near Mobile and Portable Radio Antennas.....	103
4.5 Conclusions.....	104
5.0 PROJECT MANAGEMENT	
5.1 Project Leader - Installation and Maintenance.....	107
5.2 Radio Equipment Costs.....	108
5.3 Radio Licenses.....	108
5.4 CCTV Costs.....	108
5.5 Purchasing, Receiving and Inventory Systems.....	108
5.6 Costs and Safety Benefits to the Mine.....	108
5.7 Recommendations to Other Mine Owners.....	111
5.8 Recommendations for Future U.S.B.M. Research.....	111
5.9 Pending.....	112
REFERENCES.....	113



LIST OF TABLES

	PAGE
1. Comparison of Computed and Measured Attenuation Coefficients in Limestone Slope Tunnel of Black River Mine.....	31
	APPENDIX C
2. Signal Margins Measured Above Ground on the Black River Mine Property.....	2
3. Signal Margins Measured in Western Half of Mine.....	3 & 4
4. Signal Margins Measured in Eastern Half of Mine.....	5 & 6

APPENDIX

A. Copies of FCC Radio Licenses Issued to the Black River Mining Company.....	1 - 8
B. Copy of Experimental Research License Issued to R.A. Isberg, P.E.....	1
C. Table 2 Signal Margins Above Ground.....	2
Table 3 Signal Margins in Western Section of Mine.....	3 & 4
Table 4 Signal Margins in Eastern Section of Mine.....	5 & 6

## LIST OF ILLUSTRATIONS

Figure	Page
1.1. View of Radio Shop and Mine Portal. . . . .	20
1.2 View of Entrance to the Black River Mine Property. . . . .	21
1.3 Mine Map Showing Locations of Buildings, Slope Tunnel Conveyor Belt System, Rock Crushers, Radio Control and Base Stations. . . . .	22
2.1 View Down Crosscut 104E Showing Illuminated Intersecting Crosscuts. . . . .	24
2.2 Portion of Mine Map and First Reflector. . . . .	26
2.3 Tractor Equipped for Signal Strength Survey. . . . .	28
2.4 Mobile Radio Equipment Assembly That Was Mounted on Lift Platform on the Tractor for Signal Strength Survey. . . . .	29
2.5 Circularly Polarized Antenna Mounted on Slope Car for Measuring Signal Attenuations in the Slope Tunnel. . . . .	31
2.6 Comparison of Free Space and Measured Path Attenuation At 466 and 812 MHz in the Slope Tunnel. . . . .	32
2.7 UHF Signal Strength Margins Measured in the Slope Tunnel. . .	33
2.8 Sketch of Air Shaft Used for Emergency Escape. . . . .	34
2.9A Distributed Antenna System as it Was Originally Installed in Western Sector of Mine. . . . .	36
2.9B Distributed Antenna System as it Was Originally Installed in Eastern Sector of Mine. . . . .	37
2.10 Original Plan for Redundant "Back Bone" Coaxial Control Cable. . . . .	41
2.11 Block Diagram of Radio System for the Black River Mine. . . .	42
2.12 Typical Sheet Aluminum Reflector. . . . .	43
3.1 Base Stations in Weatherproof Cabinets as Originally Installed at the Base of the Slope. . . . .	46
3.2A Portable Signal Margin Measuring Equipment. . . . .	48
3.2B Back View of Shoulder Harness Attachment to Belt. . . . .	48
3.3 Signal Margin Measuring Equipment Being Used in a Pick Up Truck. . . . .	49

LIST OF ILLUSTRATIONS (Continued)

Figure		Page
3.4A	Signal Margin Measurements Made in the Mine November 1979 Western Section. . . . .	50
3.4B	Signal Margin Measurements Made in the Mine November 1979 Eastern Section. . . . .	51
3.5	Schematic Diagram of Signal Margin Measuring Equipment. . . . .	52
3.6	Schematic Diagram of Slope Car Power Circuits. . . . .	56
3.7	Schematic Diagram of Slope Car Signaling and Alarm Circuits. . . . .	56
3.8A	Passenger Compartment of Slope Car Showing Radio Being Used. . . . .	58
3.8B	The Radio Control Head, Horn Signal and Emergency Stop Buttons on the Slope Car. . . . .	58
3.9A	Radio Communications Control Station is the Foreman's Office. . . . .	60
3.9B	MODAT Alarm and Mobile Unit Identification Decoder in Foreman's Office. . . . .	60
3.10	Map of Black River Mine Showing Extended Antenna System and Future Locations of Two Way Signal Boosters. . . . .	62
3.11A	Prototype of Two Way UHF Signal Booster in NEMA Enclosure. . . . .	64
3.11B	Chassis for Prototype Two Way Signal Booster. . . . .	64
3.12	Schematic of Signal Booster. . . . .	66
3.13	Prefabricated Radio Base Station and Monitoring Room Near Crusher No. 2. . . . .	68
3.14	Control Station and Multiplexing Equipment in Weatherproof Cabinet at the Base of the Slope. . . . .	68
3.15	CATV Line Amplifier for the "Back Bone" Cable System. . . . .	70
3.16	TV Monitors and Radio Control Equipment in Hoist House. . . . .	70
3.17	TV Camera Viewing Rock Movement Across the Transition of Conveyor Belts Above the Mine Portal. . . . .	72
3.18	Typical Radio Installation in a Mine Vehicle. . . . .	72
3.19	View of Yagi Antenna Encrusted With Limestone Dust and Smoke Particulates. . . . .	74
3.20	Typical Mobile Antenna Used for Distributed Antenna System. . . . .	74

LIST OF ILLUSTRATIONS (Continued)

Figure	Page
3.21 Schematic Diagram of Interface Unit for Motorola MODAT Digital Identification and Status Encoder. . . . .	75
3.22 Schematic Diagram of Power Circuits on Vehicles to Furnish 12 Volts D.C. to Radio. . . . .	76
3.23 Interior of Radio and Monitoring Equipment Room Showing Base Stations and Test Equipment Used for Measuring Signal Margins from a Hand Held Transceiver. . . . .	77
3.24A Mine Map Showing Signal Margins Above 20dBq Measured at a Base Station in the Monitoring Building From a Hand Held Two Watt Transceiver Operated on a Vehicle in the Western Sector of the Mine. . . . .	78
3.24B Signal Margin Above 20dBq Measured at a Base Station near Crusher No. 3 from a Hand Held Two Watt Transceiver Operated on a Vehicle in the Eastern Sector of the Mine. . . . .	79
3.25 Base Station and Combiner Cabinets Near Crusher No. 3. . . . .	82
3.26 Combiner Cabinet With Door Removed to Show FM Modulators, Demodulators, Combiner and Duplexer. . . . .	82
3.27 Final Design of "Back Bone" Cable System. . . . .	89
3.28 Composite Block Diagram of Radio and CCTV Systems in February 1981. . . . .	90
3.29 Block Diagram of Radio and CCTV Systems that Are Above Ground (Section 1). . . . .	91
3.30 Block Diagram of a Portion of Radio and CCTV Systems In the Mine (Section 2). . . . .	92
3.31 Block Diagram of a Portion of Radio and CCTV Systems In the Mine (Section 3). . . . .	93
3.32 Simplified Block Diagram for CCTV System. . . . .	94
4.1 Pattern of Holes Drilled in Limestone Face. . . . .	98
4.2 Approximate Locations of Vehicles Near Rock Face. . . . .	100
4.3 Pictures of Vehicles Near Rock Face. . . . .	102
4.4 Observers of Tests Approximately 120' From Loaded Face. . . . .	102
5.1 Operating Procedures for Portable Radios. . . . .	106

## EXECUTIVE SUMMARY

This is the final report for the design and implementation of UHF radio communications and closed circuit television systems in the Black River Mine near Butler, Kentucky. This work was accomplished by Comsul Ltd., San Francisco, California under United States Department of the Interior, Bureau of Mines, Contract No. J0377044.

The objective of the project was to demonstrate in an underground room and pillar limestone mine a minewide radio communications system that fulfills the communication needs of that type of mine.

The Black River Mine was selected as a typical metal/non metal room and pillar mine. It is nearly four thousand feet in diameter, six hundred and fifty feet deep, and has essentially straight crosscuts approximately thirty feet wide and twenty four to forty feet high with pillars approximately thirty five feet square. Entry is through a twenty two hundred foot slope by means of a single drum, hoist-powered flat car and enclosed man carrier. The emergency exit is through a hoist-powered capsule in a six foot diameter, six hundred and fifty foot vertical air shaft. Rubber tired, diesel powered mine vehicles travel along designated haulage and travel roads from the active faces on the mine's perimeter to two rock crushers, the shop area, and the base of the slope.

Mine personnel had attempted to use VHF radios for communicating in the mine but the range was limited to a few hundred feet because the frequencies that were used were less than the wave guide cutoff frequencies of the crosscuts.

Tests of communication between hand-held, two watt UHF transceivers in the room and pillar limestone mine were satisfactory for approximately two thousand feet through straight haulage ways but the range of communication at right angles to haulage ways into intersecting crosscuts was quite limited. It was evident that the radiation from the transceivers was not being reflected by the limestone pillars into the intersecting crosscuts. Two passive aluminum

reflectors, each four feet square, were installed near the ceiling and positioned 45° with the respect to the axis at an intersection of a main haulage way and a crosscut. The range of communication down the intersecting crosscuts was significantly extended. Propagation measurements on 466 and 812 MHz in the same mine demonstrated that passive reflectors are a practical and inexpensive means for extending communications into intersecting crosscuts. The same formulae and nomograms used for microwave passive reflectors can be used for UHF reflector design.

Since portable transceivers using 812 MHz were not commercially available in 1978, the radio system was designed to operate on three 451/457 MHz channels in the Special Industrial radio service. One channel is assigned to communicating with the hoist car in the slope, the second channel is for mine operations, and the third channel is for general communication on the surface and in the mine.

A leaky coaxial cable antenna system along the principal haulage and travel roads was considered but was rejected because the range of communication at right angles to the leaky cable into intersecting crosscuts would have been much less than the range of communication from antennas at the centers of major road intersections. The leaky cable system is appropriate for long tunnels but not for intersecting roads in room and pillar mines; also, a leaky cable would be more expensive than a distributed antenna system consisting of low loss transmission lines feeding numerous antennas through power dividers.

Two distributed antenna systems were designed and installed and are perhaps the first application of this technology in the mining industry.

One system with all three channels serves the slope, the center and western side of the mine. The other system, with two channels, serves the eastern side of the mine. The twelve watt base repeater stations are controlled by control stations located in the mine foreman's office and at the hoist car loading dock near the base of the slope. A third system, with all three channels, is located on the surface and feeds conventional antennas. This system is controlled by consoles in the hoist house and engineering office and by a control station in the warehouse.

All three systems can be simultaneously keyed to afford radio communications between persons in principal areas in the mine and persons above ground.

The control consoles and the base/repeater stations are interconnected through a redundant coaxial "back bone" cable system using FM modulators and demodulators on multiplexed frequencies ranging between 6.1 and 175 MHz. This is a new and unique application of CATV technology and equipment to mobile radio communication.

The "back bone" cables are installed along separate routes in order to provide redundant communication capability if one cable is damaged. One cable reaches the surface and the control equipment through the slope and the other cable is routed through a bore hole which reaches the surface near the lime plant. It is attached to poles until it reaches the control equipment in the mine office building.

Signal margin measurements of the base/repeater station signals along haulage and travel roads were made after both distributed antenna systems had been completed which demonstrated that approximately 75% of the mine area received satisfactory signals but active mining areas along the perimeter of the mine were not adequately served. Obviously, the distributed antenna system would have to be extended to serve additional antennas near the mine faces. However, the cable attenuation would so drastically reduce the power radiated from the antennas and the signals received from the mobiles and portables that very little improvement would be realized. Additional base/repeater stations were considered; however, the added complexity and cost of multiplexing equipment and for extending the back bone cable control system stimulated the development of a two-way multichannel signal booster system. A prototype signal booster was constructed and tested in the laboratory. A patent disclosure was filed since it was believed that it was a new idea. A six amplifier signal booster system was designed, ten thousand feet of cable, and sixteen additional antennas were installed in the mine in anticipation of the completion of the booster amplifiers.

Measurements also were made of signal strengths received by base station receivers from a two watt transceiver that was operated in the haulage ways.

These measurements confirmed the low signal strength margins that were received from the base stations in the same haulage ways and further justified the installation of the signal boosters. A big advantage of the two-way signal booster concept is that the distributed antenna system can be economically extended without adding control circuits or complicating the operation of the system.

Fourteen eleven watt mobile radios equipped with MODAT automatic identification and emergency alarm encoders have been installed on vehicles in the mine. The encoders that are used on four mine haulage trucks (LHD'S) have been modified to automatically send three status signals; truck bed up (dumping), truck bed down and hot engine. This information is displayed by number codes along with the truck's identification number on the MODAT display units in the engineering office above ground and the mine foreman's office underground. A record of all calls, status, and alarm messages is automatically printed in the engineering office.

Fifteen two watt transceivers equipped with automatic identification and emergency alarm encoders also are used by mine department heads, foremen and personnel in the mine.

While the radio system was being installed, some miners feared that radio transmissions might detonate blasting caps and demanded proof that the system could be safely used. A demonstration was given in the mine, with M.S.H.A. participation, which demonstrated the safe use of the radio system in the presence of electric blasting caps when the provisions of IME 20 were followed.

During the system's first year of operation, an emergency alarm that was sent by a miner who had a crushed hand is credited with bringing him prompt first aid. The miner probably would have fainted and his injury would have been more difficult to treat if prompt help via the radio system had not been available.

The radio system has greatly reduced the time required to request and deliver materials and services throughout the mine, locating foremen and supervisors, reducing supply bottlenecks, and increasing the efficiency of



the hoist operation; however, its greatest advantage is that it has enhanced the safety of personnel.

The closed circuit television monitoring system also is credited with enhancing safety, particularly at the hoist car loading area at the base of the slope. Two cameras are used at the base of the slope; one for viewing the slope car loading area and the junction of the two conveyor belts; the other camera provides a close up view of the crushed rock being transferred from one belt to the other. The third camera views the crushed rocks moving across the transition between two conveyor belts half way up the slope, and a fourth camera views the rock movement across the transition of conveyor belts near the mine's portal above ground. A fifth camera views the dust collection area in the mine where ash from the lime kilns is dumped.

The video signals from the CCTV cameras modulate FM carriers in modulators which feed the back bone cable system. All multiplexed TV camera signals are available from appropriate demodulators connected to any tap on the back bone cable system. TV monitors are provided in the hoist house for viewing the loading area and conveyor belt transition at the base of the slope and the transitions half way in the slope and above the portal. A TV monitor in the lime plant affords a view of the ash collection underground which must be contained behind dust curtains. TV monitors also are provided for the two crusher operators for viewing rock movement across transition zones of the conveyor system.

The CCTV system has become an indispensable item for the hoist operator who can see that all personnel at the base of the slope are safe and material is properly loaded before the hoist is engaged to pull the hoist car up the slope. Incipient problems that could cause rocks to pile up in hoppers at conveyor belt transitions or fine ash particles to be dispersed throughout the mine can be averted thereby reducing down time, expensive repairs, and discomfort of the personnel.

Innovative developments which should be useful in the mining industry include:

1. The use of passive reflectors for extending UHF signals into intersecting crosscuts or tunnels.
2. The development of two-way multichannel signal booster and distributed antenna systems to serve distant regions in a mine. A patent disclosure was submitted to the Bureau since some features of the signal boosters may be new and useful.
3. The development of a lightweight radio signal margin measuring unit that can be easily carried and operated by persons walking or riding through a mine.
4. The application of CATV technology and equipment for multiplexing audio, video, and digital signals for controlling mobile radio base repeater stations.
5. Development of interface units for digital mobile radio encoders in order to automatically transmit vehicle status (bed up, bed down, hot engine) to a control center.

Recommended improvements in the Black River Mine:

1. Complete the installation of improved alarm annunciators in the hoist house.
2. Install uninterruptible power systems (UPS) for radio consoles and future monitoring equipment that is located above ground.
3. Install UPS system for control stations and future monitoring equipment in the mine.
4. Evaluate and measure the two way signal strengths through the air shaft. Also, verify escape procedures by conducting a safety drill at the air shaft using the radio system for all surface to mine communications.
5. Complete six radio signal boosters, install them in the mine, and evaluate their effectiveness for extending communications to the perimeter of the mine.
6. Replace the VHF equipment used above ground with UHF transceivers and mobile equipment that is equipped with encoders

for emergency alarms and automatic identification. This system would use channel 2 and it also could accommodate one way tone and voice pagers.

7. Radio equipment for emergency communication might be available to the mine from the power company which operates the nearby nuclear power plant. Plans for using such equipment should insure compatibility with the existing system.

## Conclusions

1. A UHF two-way radio communications system has been successfully implemented in the Black River room and pillar limestone mine in accordance with Article 1, Scope of Work, of Bureau of Mines, Contract No. J0377044.
2. The safe operation of UHF mobile radio transmitters in close proximity to electric blasting caps that were loaded in a rock face was demonstrated to mine personnel, representatives of the Mine Safety and Health Administration and the Bureau of Mines Pittsburgh Research Center. This demonstration alleviated the apprehensions of miners regarding use of the radio system in the mine in accordance with the provisions of IME 20.
3. The radio system has enhanced the safety of personnel, expedited the repair of equipment in the mine, improved efficiency, and reduced delays and frustrations in communicating with key personnel.
4. The closed-circuit television surveillance system has greatly enhanced safety in the loading area at the base of the slope in the mine. It has improved efficiency and reduced costs by affording crusher operators views of incipient rock jams at junctions of the belt conveyor system in time to stop the system, thus avoiding damage to the equipment and possible ignition of belts due to friction.
5. The radio and CCTV systems that have been installed in the Black River Mine are suitable for installing in other metal/non-metal mines.

Recommendations for Additional U.S.B.M. Studies,  
Development and Research

1. Further development of the signal booster concept is needed before it can be extended into hazardous areas such as coal mines or gassy metal non/metal mines.
2. A follow-on independent evaluation will be necessary to compliment this installation work.
3. The Tx/Rx signal booster system that is being installed by Motorola in a room and pillar coal mine in southern Illinois promises to afford many advantages over sytems using conventional base/mobile relay stations and distributed or leaky antennas.
4. In many mines, CATV amplifiers and technology could be used very effectively in the same manner that it will be used in the Washington Metropolitan Area Transit Authority (WMATA) subway.
5. The Ariadne daisy chain system with IF return that has been developed in England should be tested in a mine where intrinsically safe requirements apply.
6. Further development of light weight automated signal strength measuring equipment also should be pursued.

## 1.0 INTRODUCTION AND BACKGROUND

### 1.1 Introduction, Objective and Scope of Project.

This final report summarizes the results of a design and demonstration project conducted by Comsul Ltd. San Francisco, California under a contract to the United States Department of the Interior, Bureau of Mines. The objective of the project was "To demonstrate in an underground room and pillar limestone mine a minewide communications and monitoring system that fulfills the communication needs of that type of mine".

The scope of the work included furnishing engineering and administrative services necessary to design, procure material, test, prepare installation instructions, supervise installations, operate, maintain and document the radio communications and monitoring systems.

In addition to the specified work for the UHF radio system, additional services were furnished to design a closed circuit television system and a redundant "back bone" coaxial cable system with multiplexing equipment for radio system control and television monitoring which provides communication between the engineering office and hoist house above ground and systems in the mine and which can accommodate future communication services.

The project was initiated in October 1977 and was completed in March 1981. Monthly progress reports were issued and are listed in the reference index.



FIGURE 1.1 VIEW OF RADIO SHOP AND THE MINE PORTAL. THE MINE IS ENTERED THROUGH THE 2200 FOOT SLOPE TUNNEL WHICH HAS RAILS FOR THE SLOPE CAR AND A BELT CONVEYOR FOR CRUSHED LIMESTONE.

## 1.2 Selection of the Black River Mine and Comsul Ltd. for Demonstrating UHF Radio and CCTV Systems.

The Industrial Hazards and Communications Section of the Bureau of Mines, Pittsburgh Research Center (PRC), selected the Black River limestone mine near Butler, Pendleton County, Kentucky as a suitable metal/non-metal room and pillar mine for developing and demonstrating the uses for a radio communication system.

In December 1975, the TPO visited the mine and verified that it was suitable and that the mine management personnel were interested and enthusiastic about the possibility for using radio communications to enhance the safety and efficiency of mining operations.

Mine personnel had attempted to use VHF radios for communicating in the mine, but the range was limited to a few hundred feet because the frequencies used were less than the wave guide cutoff frequencies of the crosscuts.

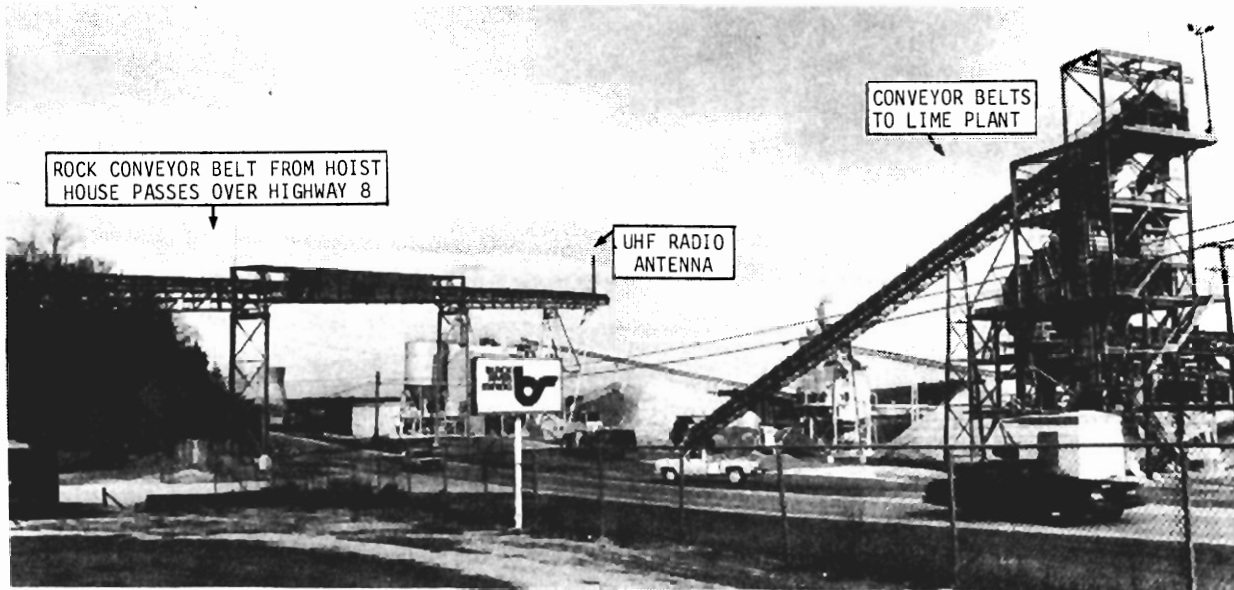

FIGURE 1.2 VIEW OF ENTRANCE TO THE BLACK RIVER MINE PROPERTY. IT IS ON KENTUCKY HIGHWAY 8, APPROXIMATELY 40 MILES SOUTH OF COVINGTON AND ONE HOUR DRIVING TIME FROM THE CINCINNATI AIRPORT.

The mine was using a VHF radio system for communicating with key personnel above ground and Citizens Band equipment for communicating with personnel at the lime plant and for coordinating the loading of barges on the Ohio river.

A cooperative agreement was negotiated between the Bureau and the Black River Mining Company and, in February 1977, the Bureau of Mines solicited proposals from communications engineering firms to design and develop an improved underground radio communications system for the mine. Comsul Ltd. was selected as the prime contractor and was awarded a contract in October 1977.

Black River Mine has a single level that is approximately six hundred fifty feet deep and it is nearly four thousand feet in diameter. It has essentially straight crosscuts approximately thirty feet wide and twenty four to forty feet high with pillars approximately thirty five feet square.

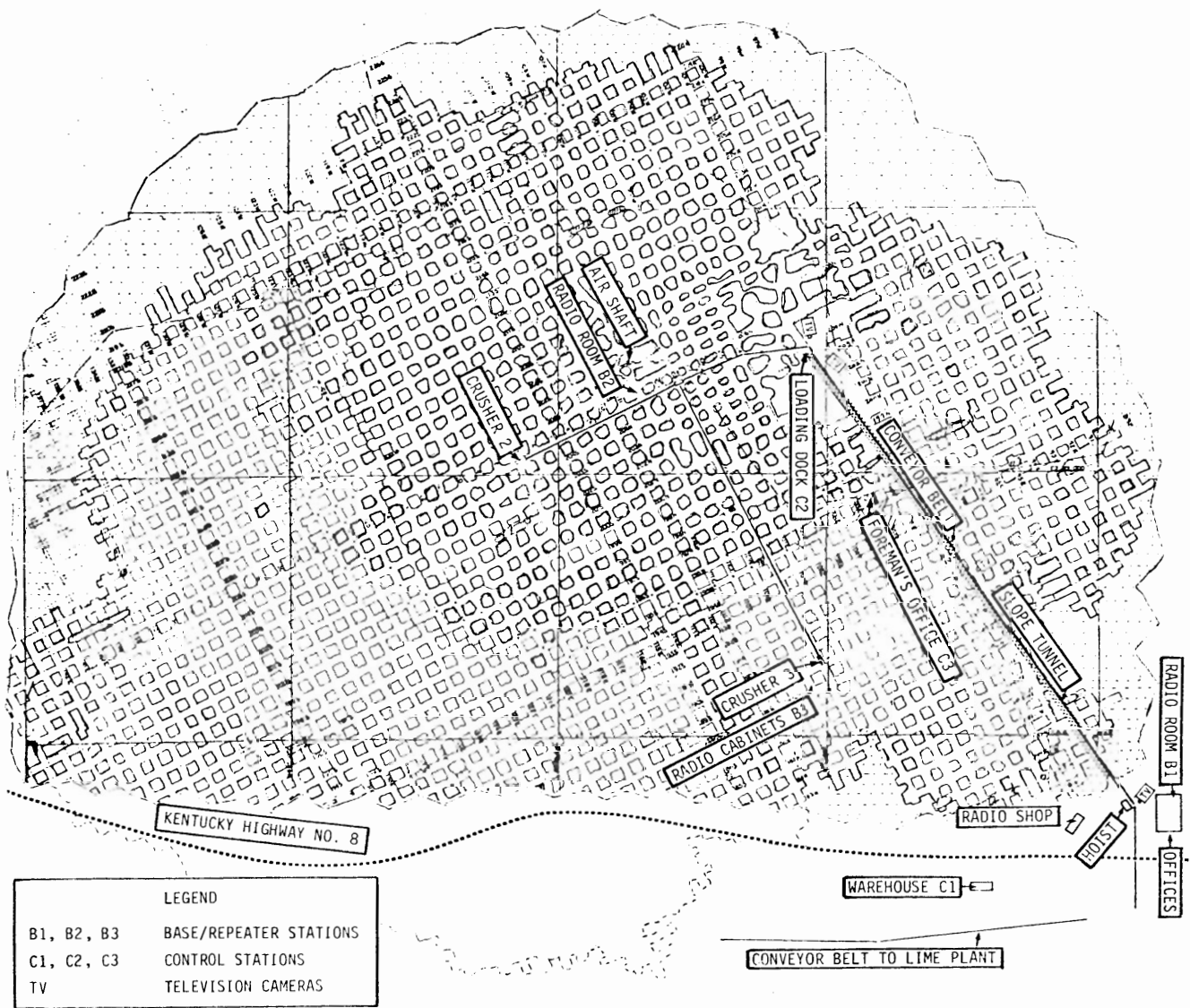

FIGURE 1.3 MAP OF BLACK RIVER MINE SHOWING LOCATIONS OF BUILDINGS, SLOPE TUNNEL CONVEYOR SYSTEM, ROCK CRUSHERS, AND RADIO STATIONS.

The mine is entered through a twenty two hundred foot slope tunnel that is approximately twenty feet wide and nine and one half feet high by means of a single drum hoist powered flat car and enclosed man carrier. The emergency exit is through a hoist powered capsule in a six hundred and fifty foot vertical six foot diameter air shaft. Rubber tired diesel powered mine vehicles travel along haulage and travel roads through designated crosscuts from the active mining faces on the perimeter of the mine to two rock crushers, the shop area and the base of the slope.



## 2.0 ENGINEERING TESTS PRIOR TO DESIGNING THE RADIO SYSTEM

### 2.1 Preliminary Qualitative Signal Propagation Tests.

Prior to beginning the radio system design Comsul's project engineer visited PRC to confer with the TPO and they also inspected the Black River Mine. The mine's general radio communications requirements were reviewed with management personnel and preliminary project goals were established. In order to obtain needed technical information regarding UHF propagation in the mine four preliminary tests were conducted in the mine to qualitatively evaluate signal strengths and propagation conditions which could affect the design of the system.<sup>1</sup>

Following is a brief summary of the test results:

1. Communications between two watt 460 MHz hand held transceivers carried by pedestrians was satisfactory in straight and essentially level crosscuts for distances up to approximately 1750 feet. The range of communications on oblique paths through a maze of pillars was approximately 800 feet. The crosscuts were approximately thirty five feet wide and twenty five feet high and the limestone pillars were approximately thirty five feet square on seventy five foot centers. Figure 2.1 is a view down a typical cross cut that is essentially straight and level. Four intersecting cross cuts are illuminated by light from the shop area. Crosscuts in old sections of the mine are not straight and the floor level is not uniform which increases the attenuation of radio signals compared to attenuations in straight and level cross cuts.
2. Signals from a two watt hand held transceiver, operated by a person riding on a tractor, to a signal strength measuring receiver at a fixed location demonstrated that satisfactory communications with a moving vehicle had a range of 1600 to 1800 feet through essentially level and straight crosscuts and approximately 800 feet in adjacent

(1) History of Project and Progress Report on Implementation of UHF Radio System in the Black River Mine, pages 2 and 3 - December 1979.



FIGURE 2.1 VIEW DOWN CROSSCUT 104E PAST LIGHTED SHOP AREA WHICH ILLUMINATED FOUR INTERSECTING CROSS CUTS.

- parallel crosscuts. However, not all of the crosscuts are level; the elevation of the mine floor varies  $\pm$  35 feet in some areas which eliminates line of sight communication even in straight crosscuts.
3. The range of two way UHF communications between two watt hand held transceivers was extended through a five watt base/mobile repeater into areas which were effectively shielded from each other by limestone pillars.
  4. Signals received by an antenna that was attached to the ceiling were stronger than signals received by a hand held transceiver which was operated by a pedestrian. Deep fades were noticed behind limestone pillars but signals were usually satisfactory in the intersections between crosscuts. Multipath distortion in low signal areas was usually reduced by shifting the transceiver location a few feet.

## 2.2 Evaluation of Test Results and Proposed Solutions of Problems

Tests 1 through 4 in the Black River Mine demonstrated that 450 MHz communication was satisfactory with two watt transceivers for approximately 1700' down a limestone crosscut that is essentially straight and level. However, the range of communication down right angle intersecting crosscuts was limited to a few hundred feet and was subject to multipath interference. This appeared to be due to the high degree of attenuation of the 450 MHz signals through the limestone pillars and the lack of efficient reflecting surfaces on their sides. The following solutions to the problem were considered:

1. The use of metal reflecting surfaces as passive repeaters.
2. The installation of a distributed antenna system using line powered transmitters to feed long transmission lines with power dividers feeding antennas located in the intersections of the crosscuts.
3. The use of leaky coaxial cable fed by base/repeater stations or daisy chain amplifiers.
4. A combination of distributed antennas and passive reflectors.

## 2.3 Investigation of Passive Reflectors and Distributed Antennas for Extending the Range of 450 MHz Communication into Intersecting Crosscuts.

A review of the design specifications for passive microwave reflectors revealed that a flat metal reflector having sixteen square feet of area would provide 29 dB of gain to a 450 MHz signal and that it should be possible to use such reflectors to extend communications into intersecting crosscuts.

In order to qualitatively verify that passive reflectors can be used for extending the range of 450 MHz communications in the mine, two 4' x 4' flat aluminum sheet passive reflectors were constructed and tested in the Black River Mine on October 26, 1977. Two reflectors were mounted on a wood frame so that the included angle between the reflecting surfaces was 90°.

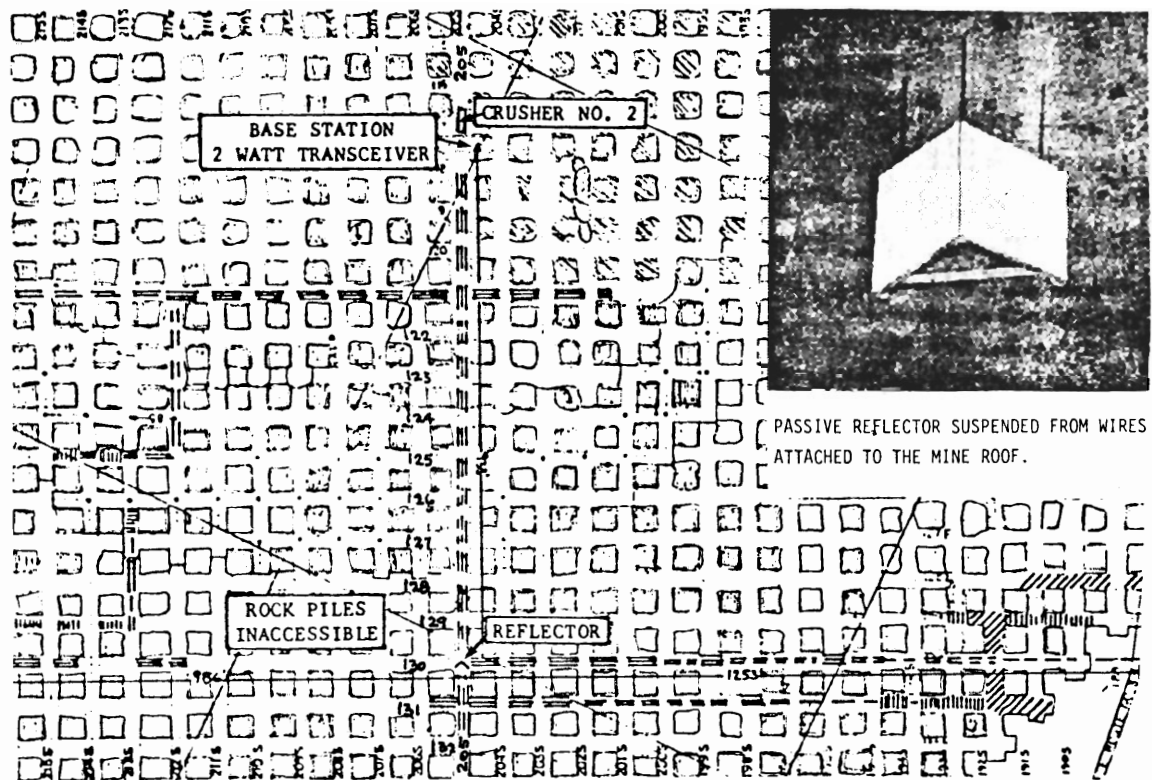

QUALITATIVE SIGNAL EVALUATION

- ≡ ≡ ≡ ≡ ≡ ≡ ≡ ≡ ≡ Excellent signal, full quieting, no multipath.
- = = = = = = = = = = Good signal, some impairment.
- - - - - - - - - - Satisfactory signal, some impairment.
- ||||| Marginal, critical squelch or multipath objectionable.
- ////// Unsatisfactory, occasionally breaking squelch.

FIGURE 2.2 PORTION OF MINE MAP SHOWING RESULTS OF FIRST TESTS OF THE PASSIVE REFLECTOR SHOWN IN THE INSERT.

The apex of the reflector was aligned along the axis of crosscut 205S facing the base station site at Crusher No. 2 as shown above. The reflecting surfaces were at 45° angles with respect to the axis of crosscuts 130 (E and W). A two watt 450 MHz transceiver was operated as a fixed station in crosscut 205S near crusher No. 2. It communicated with similar transceivers which were carried by persons walking through intersecting and parallel cross cuts to qualitatively evaluate the range and quality of communications. The passive reflector definitely enhanced two way signal strengths in crosscut 130 compared to the signal evaluations in parallel crosscuts 128, 129 and 131. <sup>3</sup>

(3) History of Project and Progress Report on Implementation of UHF Radio System in the Black River Mine, pages 4 and 5, December 1979.

## 2.4 Tests to Compare Communications on 812 and 466 MHz.

During November 1977, a series of signal strength measurements were made in the Black River Mine on 466 and 812 MHz to obtain signal propagation data in a room and pillar metal/non-metal mine. These measurements included studies of vertical, horizontal and cross polarization in addition to measurements of passive reflector performance. The data was summarized in the December 1979 project history report and it was also summarized in a paper by R.A. Isberg and R.L. Chufo. <sup>2</sup>

The signal strength measuring equipment and base stations were located in a large trailer van near Crusher No. 3. This location was near 115 volt A.C. power and it also was near the outer perimeter of the mine affording a large area of long intersecting crosscuts for the signal strength measurements.

Signal strengths of 466 and 812 MHz radio transmissions received by the base station receivers were simultaneously recorded on two channel strip chart recorder and four channel instrumentation audio tape recorder. Modified signal quality modules from a receiver voting system were used for measuring signal strengths above carrier quieting. Since the modules measured audible noise, the carriers were not modulated during the measurements. The receivers and voting modules were calibrated with signal generators and all readings were in microvolts input to the receiver antenna receptacle.

An array of eight antennas was attached to a roof bolt at the center of intersecting crosscuts 190S and 111E. Two 10dB gain Yagi antennas and one unity gain omnidirectional antenna were used for tests on 466 MHz. Each antenna was connected to a transmission line leading into the van where they were connected to the base station receivers as required.

- (2) Isberg, R.A. and R.L. Chufo, Passive Reflectors as a Means for Extending UHF Signals Down Intersection Crosscuts in Mines or Large Corridors, 28th Conference Record IEEE Vehicular Technology Society, March 1978.

The mobile radio equipment was mounted on a plywood assembly which was strapped to the lift platform on a utility tractor as shown on Figures 2.3 and 2.4. This assembly included a lighted map shelf unit, and an audio tape recorder for recording voice transmissions received and transmitted as well as the field engineer's and driver's comments. The mobile radios transmitted simultaneously on 812 and 466 MHz while the tractor was moving and the signal strengths were recorded at the control center in the van.



FIGURE 2.3 TRACTOR EQUIPPED FOR SIGNAL STRENGTH SURVEY

For vertically polarized transmissions, one quarter wave length whip antennas were mounted on ground planes on top of two poles attached to the tractor. For horizontally polarized transmissions, the antennas and ground planes were reoriented  $90^{\circ}$  so that they were perpendicular to the fore and aft axis of the tractor.

In order to compare the merits of horizontally and vertically polarized transmissions, two runs were made by the mobile unit over the same routes through the mine. There were no significant differences between the range of propagation on 466 and 812 MHz. Although horizontally polarized signals evidently were more efficiently propagated through intersecting crosscuts and around pillars, vertical polarization is most practical for mobile and transceiver antennas except on fixed route or rail vehicles. The tests indicated that the polarization of the signals received at the van evidently was altered by reflections and multipath propagation.

The signal strength survey routes through the mine are shown on charts that are included in the Project Reports.<sup>4</sup>

(4) History of Project and Progress Report on Implementation of UHF Radio System in the Black River Mine, Comsul Ltd. Report to BOM TPO, Figures 1-4, December 1979.

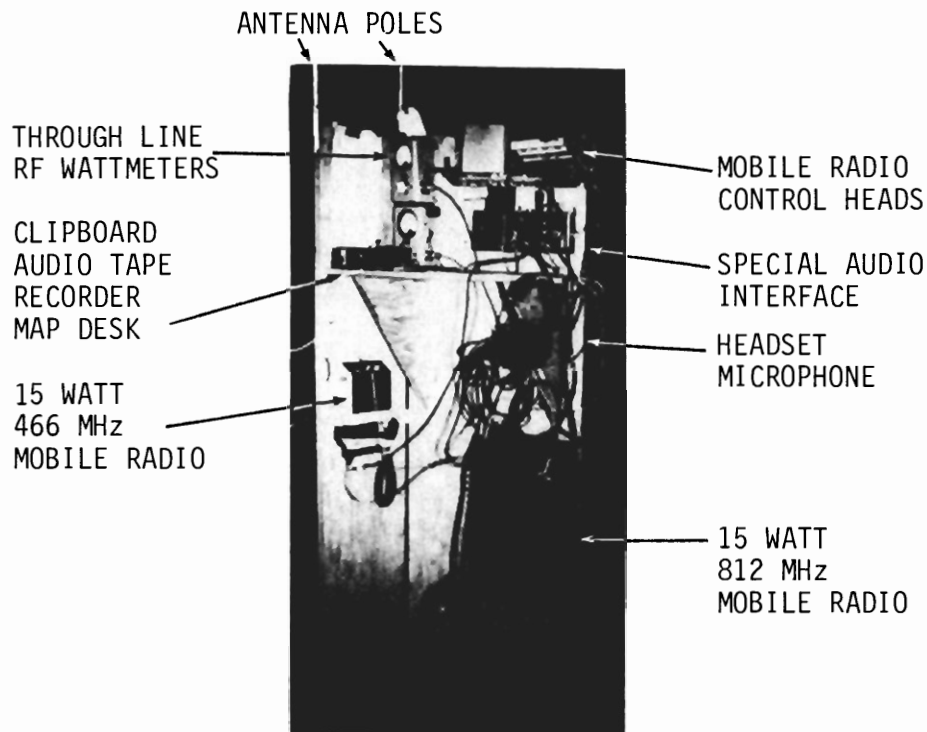

FIGURE 2.4 MOBILE RADIO ASSEMBLY THAT WAS MOUNTED ON LIFT PLATFORM ON TRACTOR FOR MOBILE SIGNAL STRENGTH MEASUREMENTS.

The special audio control unit shown on Figure 2.4 was constructed by Bureau of Mines' technicians for controlling the modulation of both transmitters and for interfacing the audio tape recorder and two headset microphones which were worn by the tractor driver and mobile radio operator. The audio tape recordings made on the mobile unit were very helpful for identifying the regions where the mobile unit was not heard at the control center. At each intersection, the tractor driver would announce the mobile unit's location. The signal strength measurements were made while the mobile unit was in motion and the median values were tabulated from the chart recording. Audio tape recordings were also made of all communications received in the control center which were later compared and correlated with the signal chart readings and positions of the mobile unit. By comparing the two audio tape recordings, the routes followed by the mobile unit were marked later on mine maps showing locations of all transmissions that were attempted as well as those which were received.

## 2.5 Signal Strength Measurements to Verify Reflector Performance

A series of signal strength measurements were made on November 17, 1977 to verify the qualitative tests which were previously described in this report on page 26. Three additional 4' x 4' reflectors were constructed and were hung in major haulage way intersections.

The tests confirmed that reflectors definitely increased signal strengths and reduced multipath distortion in the crosscuts extending from the intersections where they were installed. The reflectors are most effective if they are not more than 500 feet line of sight from a transmitting antenna and are illuminated by a strong signal. Reflectors are effective with either horizontal or vertical polarization. However, vertical polarization is most appropriate for omnidirectional antennas.

## 2.6. Measurements of Signal Attenuations Through the Slope Tunnel

The attenuations of 466 and 812 MHz signals were measured in the 2200 foot slope of the Black River Mine and the results are plotted on Figure 2.6 along with the two free space attenuation curves. The 466 and 812 MHz vertically polarized signals from the mobile unit, which was parked at the base of the slope, were measured on the slope car as it was pulled through the slope tunnel.

The signals received by a wide band circularly polarized log periodic antenna and field strength meter were recorded on the slope car by an instrumentation tape recorder and a chart recorder. See Figure 2.5.

A mathematical study was made for the Bureau of Mines by Arthur D. Little, Inc. of the propagation characteristics in the slope of the Black River Mine using the data shown on Figure 2.6. The sum of the computed attenuation coefficients for refraction, roughness and tilt were equal to the measured values as is shown on Table 1.<sup>5</sup>

- (5) Lagace, Robert L. and Alfred G. Emslie, Propagation of UHF Radio Waves in Limestone Room and Pillar Mines, Arthur D. Little, Inc. Bureau of Mines Report for J0387217



| TABLE 1<br>COMPARISON OF COMPUTED AND MEASURED ATTENUATION COEFFICIENTS<br>IN LIMESTONE SLOPE TUNNEL OF BLACK RIVER MINE |            |           |         |         |                   |
|--|------------|-----------|---------|---------|-------------------|
| COMPUTED ATTENUATION COEFFICIENT $\alpha$  |            |           |         |         | Measured $\alpha$ |
| f  | Refraction | Roughness | Tilt    | Total   |                   |
| mHz  | dB/100'    | dB/100'   | dB/100' | dB/100' | dB/100'           |
| 466  | 3.60       | 0.551     | 0.377   | 4.03    | 4.02              |
| 812  | 1.43       | 0.029     | 0.589   | 2.05    | 2.03              |

Measurements of  $\alpha$  in the larger cross-section area crosscuts in the Black River Mine have not been made, but signal margin measurements have indicated that 4 dB/100' beyond the first 300' from an antenna is a conservative value unless line of sight conditions are impaired by variations in floor elevation or alignment of pillars. Satisfactory two-way signal strengths are obtained within a 500-foot radius from a base/repeater antenna that is radiating approximately one-tenth watt effective radiated power and a hand-held transceiver that is radiating two watts. Beyond 500 feet from the base/repeater antenna, signal strengths diminish rapidly in crosscuts which are parallel to the crosscuts that are illuminated by the base repeater antenna.

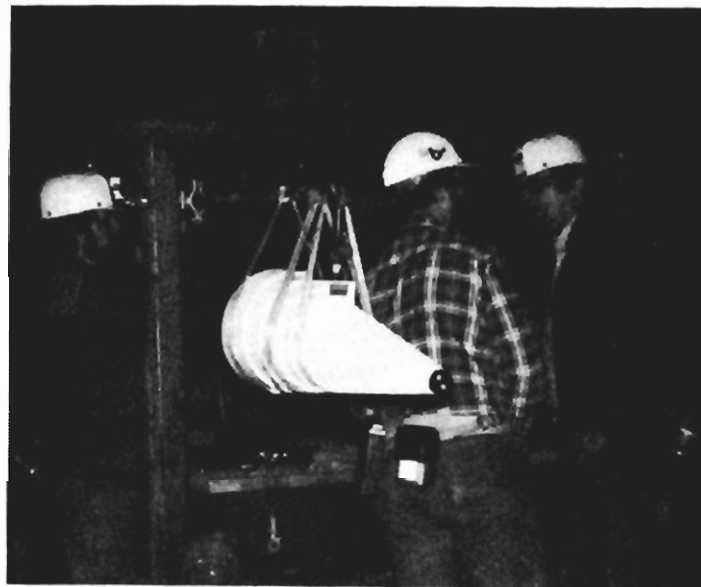

FIGURE 2.5. CIRCULARLY POLARIZED ANTENNA USED FOR SIGNAL STRENGTH MEASUREMENTS IN THE SLOPE TUNNEL.

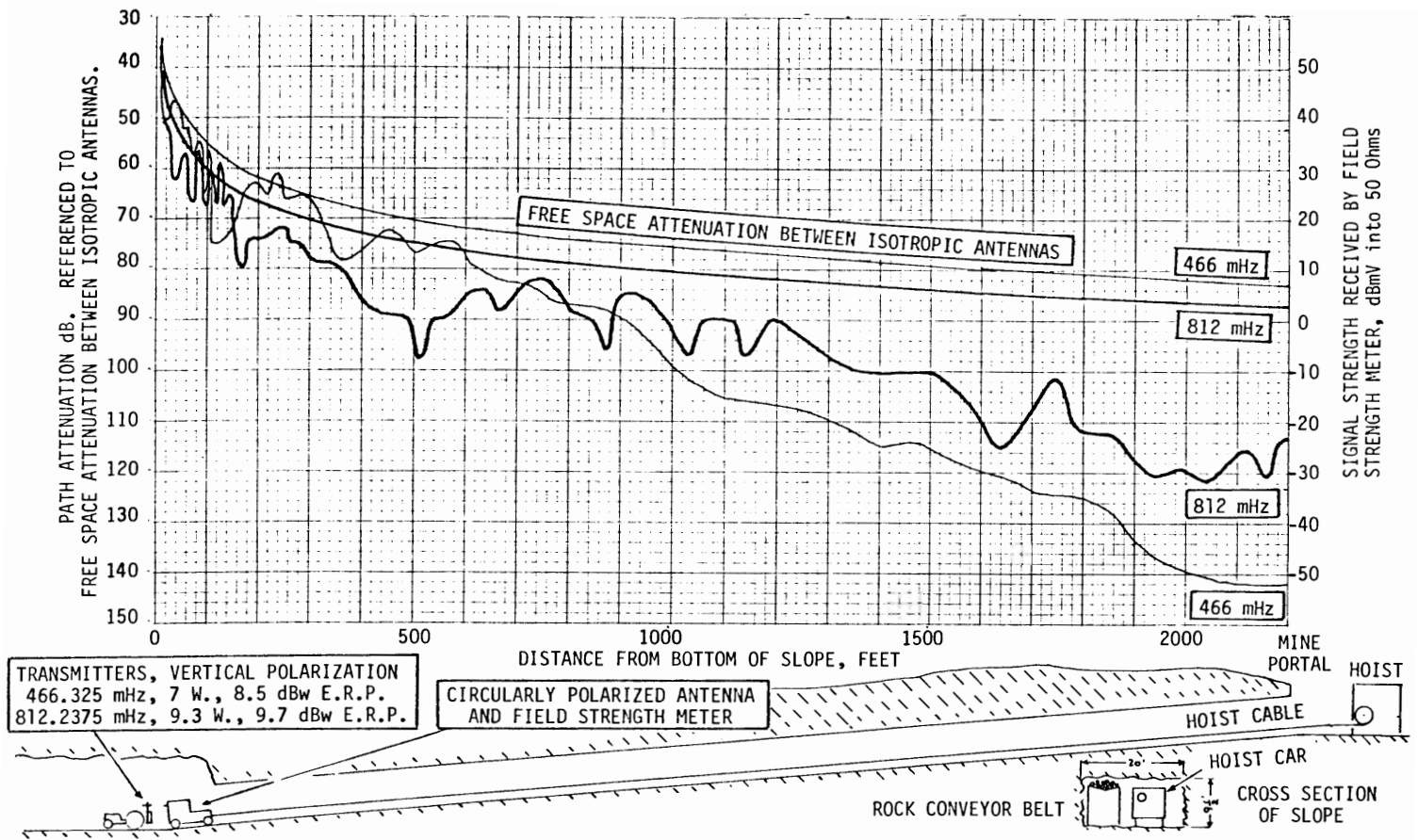

FIGURE 2.6  
 COMPARISONS OF FREE SPACE AND MEASURED PATH  
 ATTENUATIONS AT 466 AND 812 MHz IN THE SLOPE TUNNEL

The signal strength measurements that are shown on Figure 2.6 were recorded on a chart recorder. Measurements were made while the car was ascending the slope and were repeated while it descended. The two sets of chart recordings were compared and the average of the two readings was plotted on the graph.

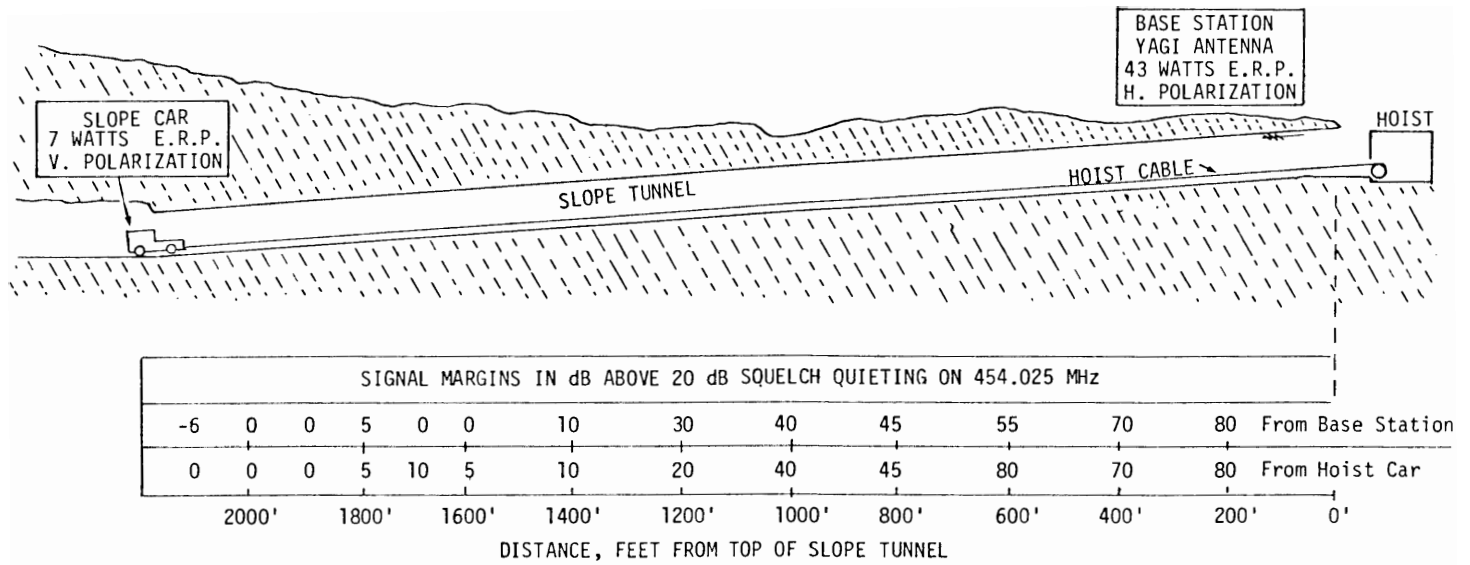

FIGURE 2.7. SIGNAL STRENGTH MARGINS ABOVE 20 dB CARRIER SQUELCH QUIETING IN THE SLOPE TUNNEL.

On May 11, 1979, signal strength or fade margins above 20 dB carrier squelch quieting were measured on the slope car as it descended into the mine while the base station above ground was continuously keyed. The measurements were repeated at the base station while the radio on the slope car was continuously keyed.

During the tests, a vertically polarized "hard hat" antenna was used on the slope car. It has been replaced by a horizontally polarized whip antenna which has noticeably improved the fade margins but they have not been re-measured.

## 2.7 Tests of Portable to Portable UHF Radio Communications Through the Air Shaft Emergency Exit.

On December 8, 1977, qualitative tests were made to determine the effectiveness of 450 MHz radio communication between the bottom of the air shaft and various points in and around the escape hatch on the surface.

The air shaft is six feet in diameter and extends vertically six hundred and thirty feet to a plenum chamber on the floor of the mine. The top of the air shaft is covered by a metal housing that is attached to two horizontal air inlet ducts containing large impeller type fans. (See Figure 2.8).

The air shaft also provides an emergency exit to the surface in the event that the slope cannot be used. The top of the shaft has an access hatch for lowering a tubular metal escape bucket which is attached to a steel cable from an electrical motor driven winch located in a hoist house approximately twenty five feet from the air shaft. The following test results were obtained:

1. As expected, communications in the 450 MHz band is possible through a straight limestone air shaft which is six feet in diameter and 650 feet long. The transceivers were aligned near the axis of the air shaft and polarization was approximately vertical.
2. Communication was ineffective through three foot diameter fan ducts which join the air shaft at right angles.
3. Communication from the plenum chamber at the bottom of the air shaft to the interior of the hoist house was surprisingly good. This might have been due to the UHF induction into the hoist cable.

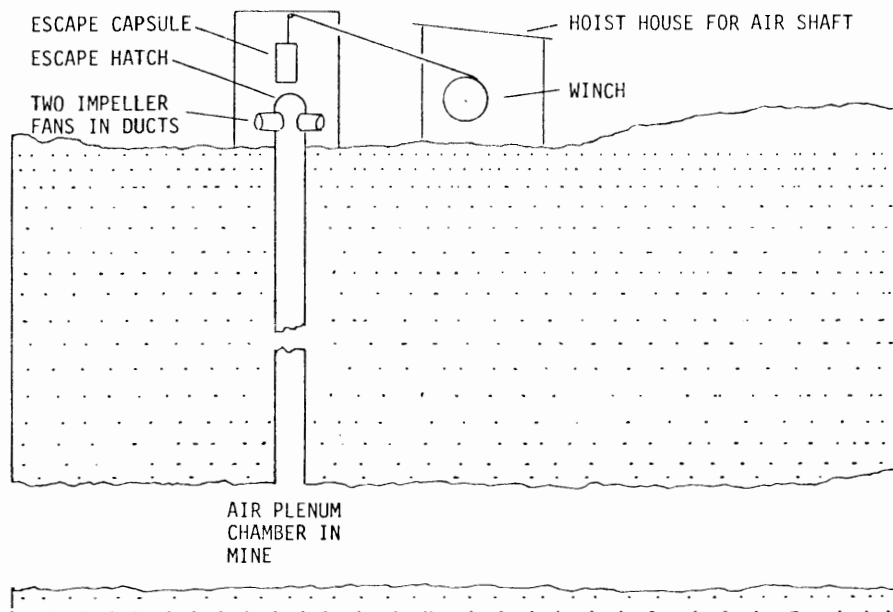

FIGURE 2.8 SKETCH OF AIR SHAFT USED AS EMERGENCY EXIT.

## 2.8 Design and Procurement of UHF Radio System

Following the analysis of the data which was obtained from the propagation tests, a 450 MHz radio system was designed which would use a combination of distributed antennas and passive reflectors to afford two way communications along principal haulage and travel roads in the mine. During design conferences in May and June 1978, the scope of the project was expanded to include a redundant multiplexed "back bone" coaxial cable system for radio and CCTV systems control. The radio system was designated Phase I and the CCTV monitoring system was designated Phase II of the project. A design report was prepared and submitted to the TPO for review and comments.<sup>6</sup>

The system plan required three UHF radio two frequency simplex channels licensed in the 451/456 MHz Special Industrial Radio Service for digitally calling and identifying mobiles and transceivers, digital alarms and data, and voice communications.

Channels 1 and 2 were to be used principally for communications between mobile radios and transceivers in conjunction with both mining and above ground operations. They also were to be used for back up of channel 3 in the slope in the event of equipment failure.

Channel 3 was to be used solely for communicating between the hoist operator and the hoist car in the slope of the mine. One base/mobile relay (BMR) station using channel 3 near the hoist house was to feed a high gain Yagi antenna that is directed down the slope. The hoist car in the slope was to be equipped with a mobile radio which normally would be used on channel 3 but it could be switched to use channels 1 and 2 if channel 3 did not function. Alarm switches were to be provided on the hoist car for sending digital alarm signals to the hoist operator. However, this system was modified to conform with the mine's horn signal system.

- (6) Proposed Radio System for the Black River Mine, Comsul's report to Bureau of Mines, TPO, March 1978.

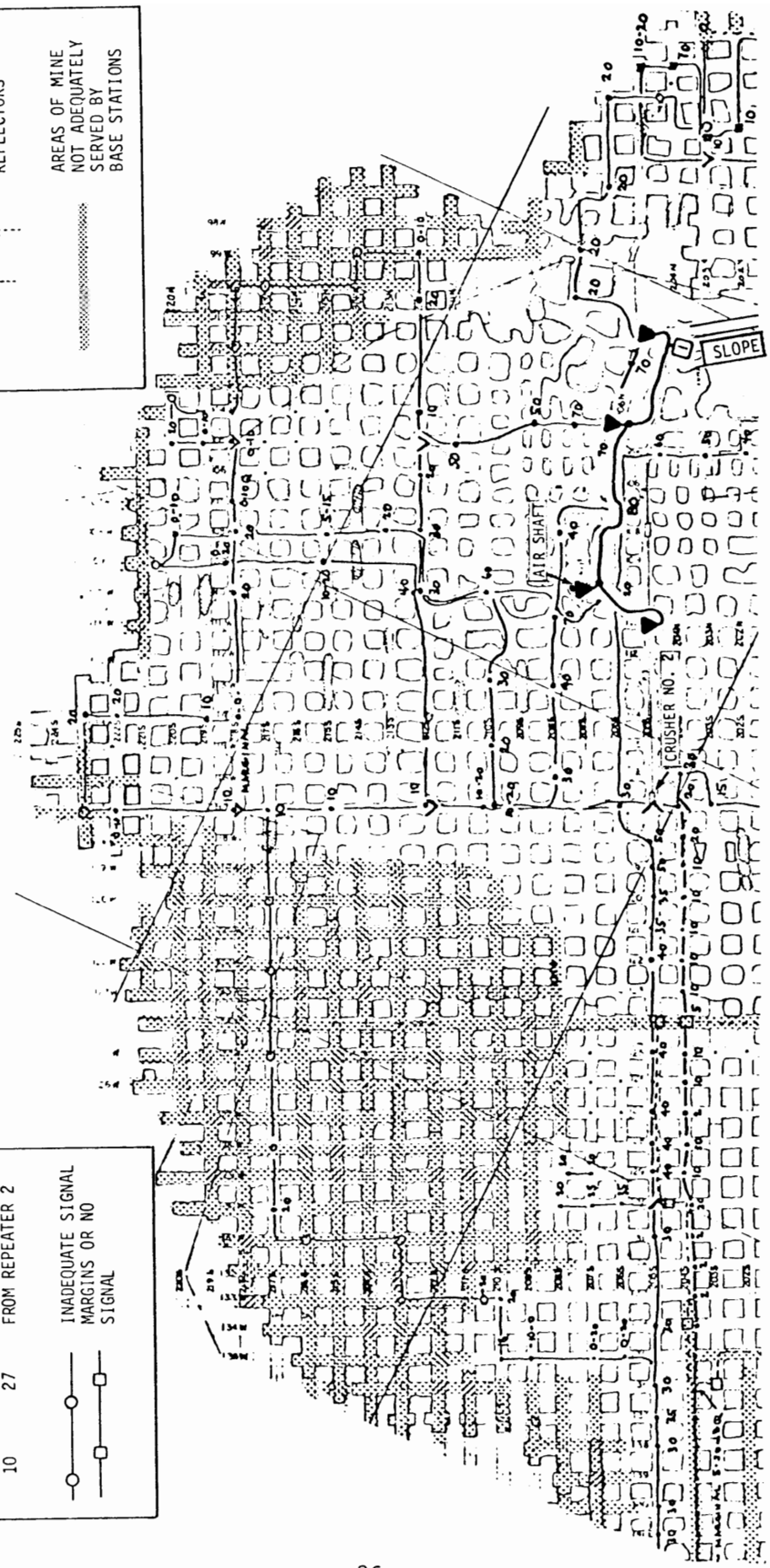
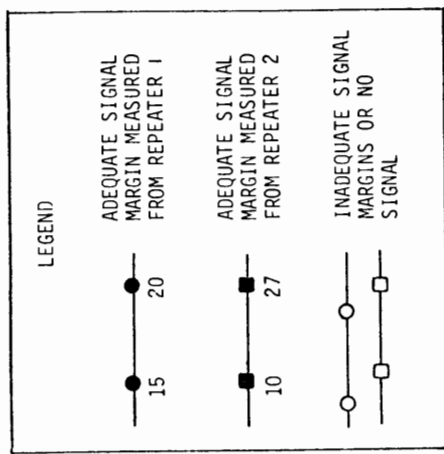
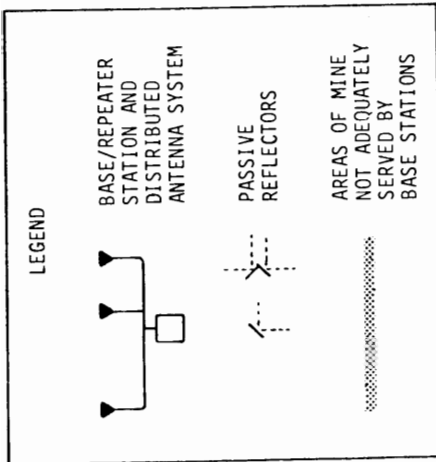

FIGURE 2.9A DISTRIBUTED ANTENNA SYSTEM AS IT WAS ORIGINALLY INSTALLED IN WESTERN SECTOR OF THE MINE AND THE COVERAGE IT AFFORDED.

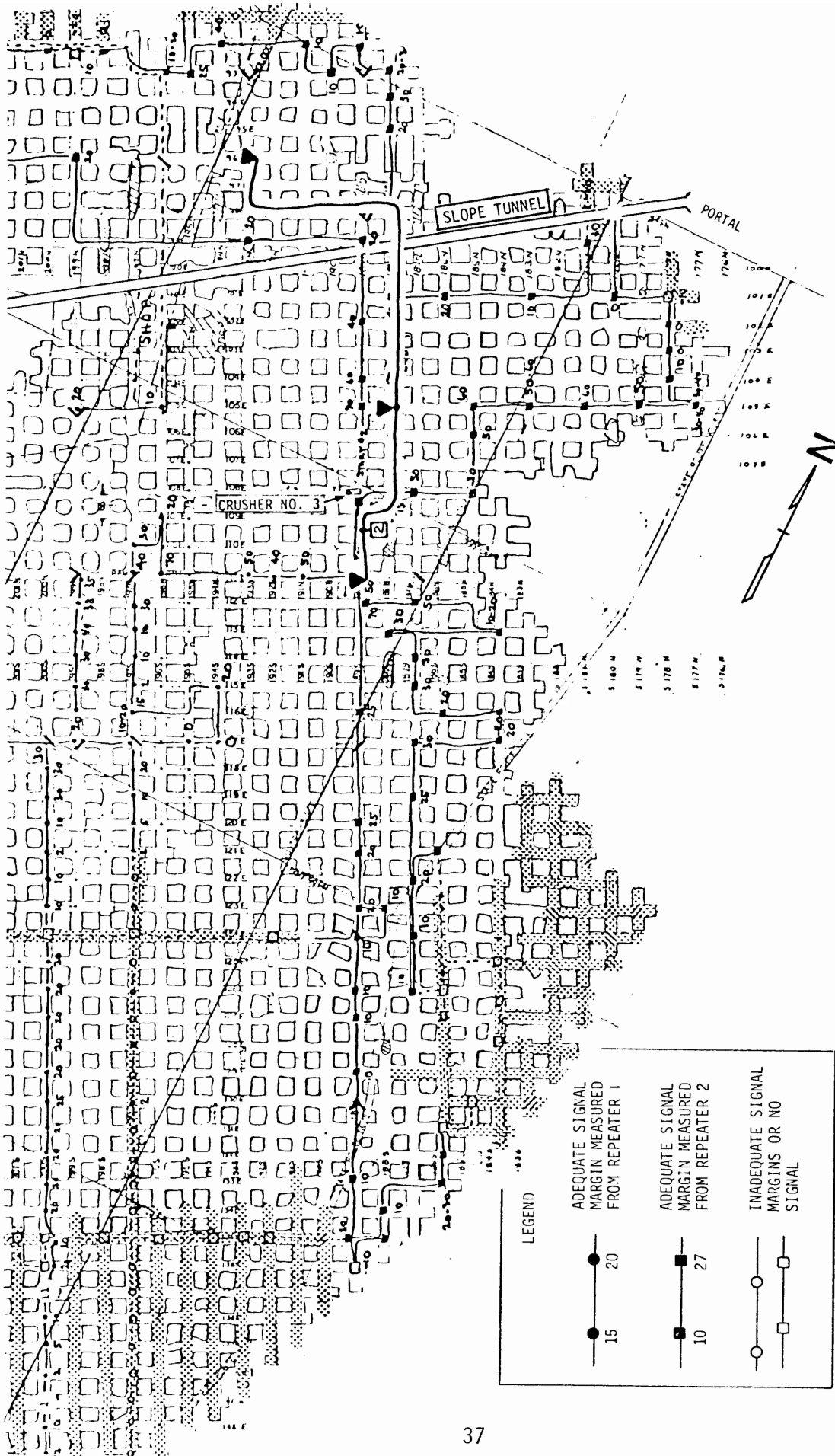

FIGURE 2.9B DISTRIBUTED ANTENNA SYSTEM AS IT WAS ORIGINALLY INSTALLED IN THE EASTERN SECTOR OF THE MINE AND THE COVERAGE IT AFFORDED.

Three pairs of base/mobile relay stations using channels 1 and 2 for general communications were to be provided, one pair at the hoist house near the mine portal, one pair near the base of the slope in the mine and one pair near crusher no.3 in the mine. Each pair of underground base stations was to feed a distributed antenna system through a combiner.

Two control stations for channels 1, 2 and 3 were to be provided, one at the warehouse above ground and one near the base of the slope in the mine. A third control station for all channels was to be located in the underground shop office.

Two underground antenna systems using a combination of distributed antennas and passive reflectors were to be located at intersections of main haulage ways as shown on Figure 2.9.

The system design objective was to afford reliable two way communications between 1.5 watt portable transceivers operating near main haulage ways in the mine, in the slope, in the air shaft and air shaft hoist house, and above ground along the roads and in buildings which are near the mine portal. As is shown on Figure 2.9 complete coverage of the mine was not realized by the original antenna system which was later modified by extending the transmission lines, installing additional antennas and providing for future two way signal booster amplifiers.

All base/mobile relay stations, control stations, alarm annunciators and control consoles were to be operated by storage batteries and chargers which will afford uninterrupted operation during power failures.

A redundant "back bone" coaxial cable system was to be provided for multiplexed audio and digital signal and closed circuit television surveillance of conveyor transfer points and rock crusher operations. Multiplexing signals on coaxial cable is a new concept for controlling mobile radio communications systems in mines.

Standard CATV industry hardware and concepts were specified for the "back bone" cable system using multiplexed FM carriers in the 5 to 300 MHz spectrum.



The 5 to 30 MHz spectrum was to be used for communication from above ground into the mine, 50-300 MHz for mine to the surface and the 30-50 MHz spectrum was to be used for crossover filtering. The FM modulators and demodulators were to be powered through the back bone cable by 60 volts AC and batteries were to be provided to insure uninterrupted operation during power outages.

Two "back bone" cables were to be installed through the mine in adjacent crosscuts, one of the cables was to extend up to the slope to the radio room on the surface and the other cable was to extend through a bore hole to the surface.

In the event that the back bone cable extending up the slope is damaged the other cable would be used for controlling the base/repeater stations in the mine.

Radio control consoles were to be provided in the hoist house and in the engineering office for controlling all base/mobile relay stations. A radio receiver voting system was to be used for selecting the best signal received from transceivers and mobiles. The system was to operate under either the control of an attendant or as a base/mobile repeater relaying communications between transceivers and mobile units.

The equipment for the radio system included:

- Three twelve watt base/mobile relay (BMR) stations on the surface near the hoist house for above ground and slope communications.
- Two twelve watt BMR stations near the base of the slope in the mine with an associated combiner to feed four antennas at principal intersecting haulage roads in the center of the mine as shown on Figure 2.9.
- Two twelve watt BMR stations near crusher no. 3 with a combiner to feed four antennas at major haulage road intersections in the eastern sector of the mine.

- Two control consoles including voting signal comparitors; one for the engineering office and the other for the hoist house.
- Three twenty watt control stations located in the warehouse, the loading area at the base of the slope and the mine foreman's office in the underground shop.
- Ten six watt mobile radios with MODAT automatic identification alarm and status encoders for mine vehicles.
- Fifteen two watt portable transceivers with automatic identification and alarm encoders.
- Two coaxial back bone cable systems including 15,000 feet of 7/8" aluminum jacketed cable, and six CATEL FM modulators and six CATEL FM demodulators, four two way CATV line amplifiers and associated items. See Figures 2.10 and 2.11.
- Test equipment for the radio and "back bone" cable systems.

Comsul's preliminary radio system design report was revised August 2, 1978 and a purchase order for the test equipment, radio and "back bone" cable system was issued by the Bureau of Mines on August 16, 1978. In September 1978 Comsul began negotiations with Motorola Communications & Electronics, Inc. to furnish the services of a full-time Project Leader to install and maintain the radio and CCTV systems, to instruct mine personnel regarding its operation, keep records of the systems installed and furnish monthly progress reports. This position was filled by Mr. Jerry Bentz a radio technician for Motorola Communications & Electronics, Inc. Cincinnati, Ohio.<sup>7, 8, 9</sup>

- (7) Proposal for Black River Mining Company Project, Motorola Communications & Electronics, Inc., July 6, 1978.
- (8) Proposed Radio System for Black River Mining Company, Comsul Ltd., Report to Bureau of Mines TPO, August 4, 1978.
- (9) Bureau of Mines Purchase Order No. P0382795 for Radio Equipment for the Black River Mine, September 8, 1978.

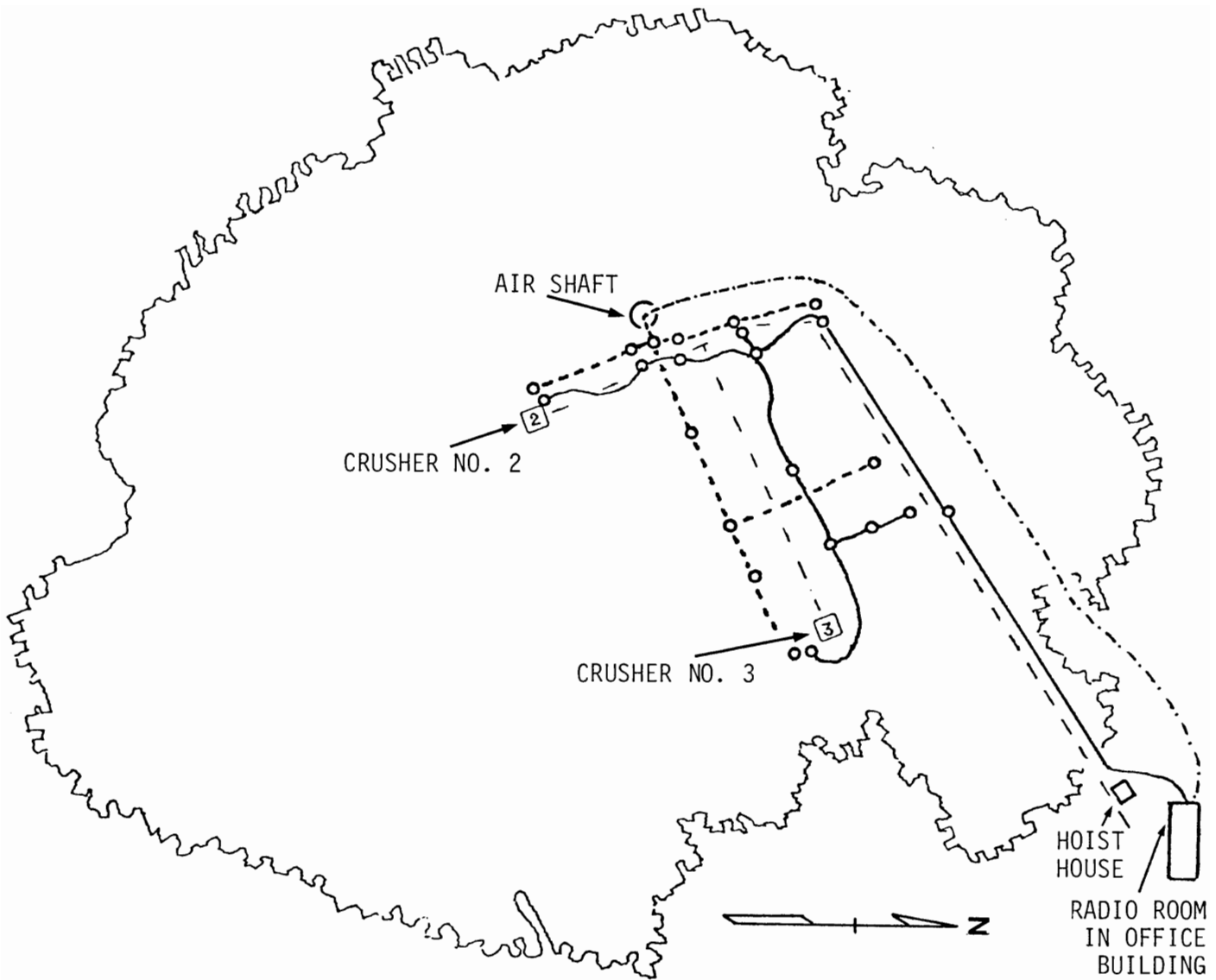

LEGEND

- BACK BONE CABLE NO. 1 INSTALLED THROUGH SLOPE.
- - -○- - - BACK BONE CABLE NO. 2 INSTALLED IN MINE.
- · - · - · - · - · BACK BONE CABLE ABOVE GROUND TO RADIO ROOM.
- The circles in the cable represent multicouplers for connecting multiplexing FM modulators or demodulators
- - - - - ROCK CONVEYOR BELT.

FIGURE 2.10 ORIGINAL PLAN FOR REDUNDANT BACK BONE COAXIAL CONTROL CABLE.

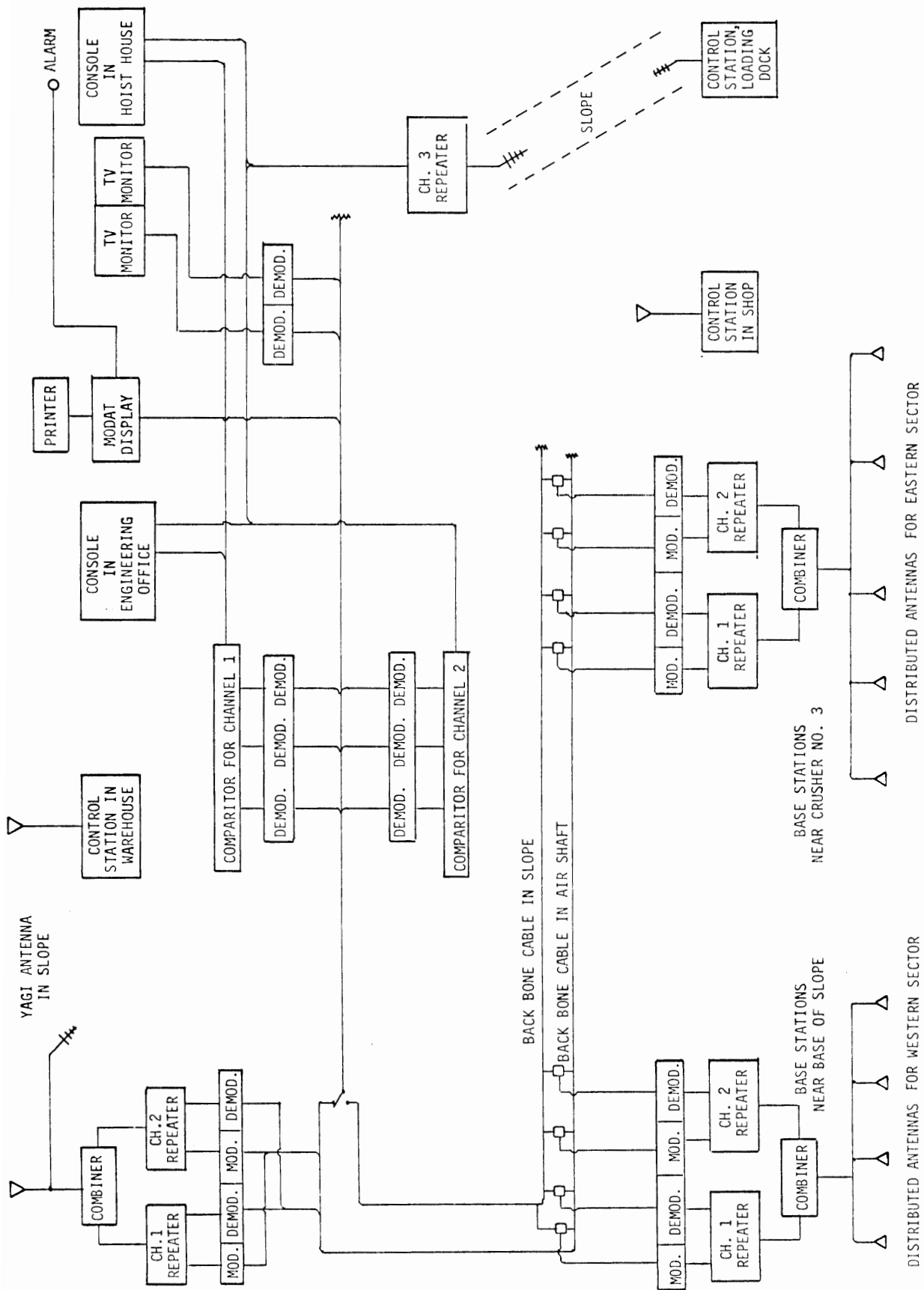

FIGURE 2.11. BLOCK DIAGRAM OF RADIO SYSTEM FOR THE BLACK RIVER MINE

## 2.9 Design of Distributed Antenna and Passive Reflector Systems

The principal haulage and travel roads through the mine were identified on a map of the mine. Two distributed antenna systems were designed, as shown by solid lines on Figure 2.9 to provide either an antenna or reflector at the intersection of principal haulage and travel roads. Each antenna system consisted of approximately 1,200 feet of 7/8" low loss foam dielectric transmission line which fed, through 2 to 1 power dividers, four 5 dB gain mobile whip antennas that were suspended above the centers of principal intersections. Two thirteen watt base stations were connected through hybrid combiners and a power divider to feed approximately 7.1 dBw (5.1 watts) into each branch of the tee section transmission line.

The effective radiated power from the various antennas ranged from 17 watts for the antenna nearest to a base station to 0.05 watts for the antenna farthest from a base station. The signals from transceivers received at the most distant antennas were attenuated 21 dB by losses in the transmission line and power dividers.

Twenty-seven passive reflectors, also shown in Figure 2.9 were installed at principal intersections to enhance signal strengths. The reflectors which received line of sight signals over paths that were less than 1,000 feet long were very effective but reflectors which were not within line of sight of a ceiling mounted antenna did not appreciably extend the range of communication.

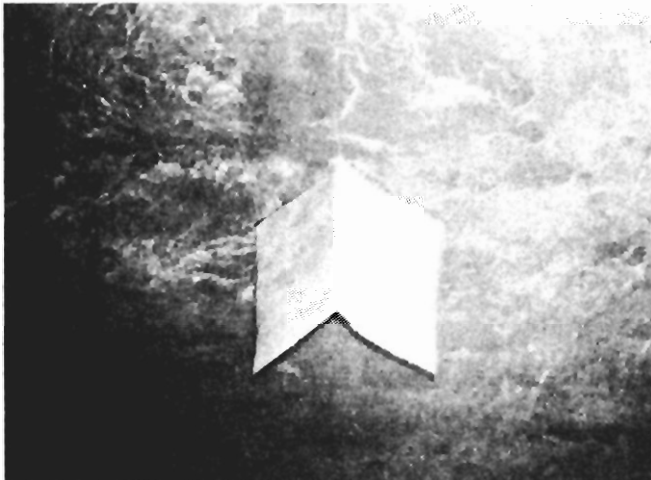

FIGURE 2.12 TYPICAL REFLECTOR

The reflectors were formed from sheets of 4' x 8' #16 gauge soft aluminum sheet that are suspended by wires attached to roof plates and rock bolt anchors at the centers of intersecting travel and haulage roads. The apex is pointed toward the nearest base station antenna.

Since the roof to floor heights in the Black River Mine vary between twenty-four and thirty-four feet, a four by four foot reflector was a practical size to permit adequate clearance to vehicles moving below it. For 466 MHz the reflector should be at least one wave length high (25") but it can be as wide as required to attain the desired area and gain.

The path attenuations  $A_1$  and  $A_2$  are approximately equal to the free space attenuation in dB for the first 300' plus a fixed attenuation coefficient  $\alpha$  in scattering loss due to roughness of walls, roof and floor and scattering due to tilt of the mean planes of the walls, roof and floor. Fig. 2.6 (p. 32) shows comparisons of free space attenuation and measured attenuation on 466 and 812 MHz in the 2200' slope tunnel which is 9.5 x 20' cross section area.

The path loss between a base station antenna and a transceiver that is operating in a crosscut which is illuminated by a reflector is equal to:

$$A_{\text{Total}} = A_1 + A_2 - G_R$$

$A_1$  is the attenuation from the base station antenna to the reflector.

$A_2$  is the attenuation from the reflector to the transceiver antenna.

$G_R$  is the gain of the reflector which is equal to 29 dB for a 16 square foot reflector at 460 MHz.  $G_R$  can be computed using the following formula:

$$G_R = 22.2 + 40 \log_{10} f + 20 \log_{10} A + 20 \log_{10} \cos \theta$$

$G_R$  = Two way gain of reflector in dB

$f$  = Frequency in GHz

$A$  = Area of passive reflector in square feet

$\cos \theta$  =  $\frac{1}{2}$  of the included angle between the incident and reflected paths.

Following is a computation of line of sight path attenuation and signal margin at a transceiver operating on 466 MHz which is 400' from a reflector that 800' from a base/repeater antenna radiating 0.4 watts.

|                            |  |   |
|----------------------------|--|---|
| Path A <sub>1</sub> (800') | First 300' free space  | -66 dB  |
|                            | 100' @ 4 dB/100  | - 4 dB  |
| G <sub>R</sub>             | Reflector Gain   | 29 dB   |
| Path A <sub>2</sub> (800') | First 300' free space  | -66 dB  |
|                            | 500' @ 4dB/100'  | -20 dB  |
|                            | Antenna derating factor for transceiver  | <u>-10 dB</u>   |
|                            | Total Attenuation  | -137 dB   |
|                            | Distributed antenna ERP 0.40 W   | <u>26 dBm</u>   |
|                            | Received signal power  | -111 dBm  |
|                            | Signal power required by receiver for 20 dB quieting (0.5 uv input to 50 ohms) | -113 dBm  |
|                            | Signal margin above 20 dB quieting   | 2 dBm which is a noisy but generally usable signal. A 10 to 20 dB signal margin would provide reliable communication. |

### 3.0 Installation and Implementation of the Radio System

Installation of the radio system began in April 1979 and the progress was described in monthly technical reports that were issued by Comsul Ltd. Highlights of the reports are:

#### 3.1 April - May 1979

Essentially all of the material and equipment that had been ordered for the back bone cable and radio systems were received and inventoried. The channel 3 radio system was installed and began operating in the slope for communicating with the slope car, the base of the slope, the hoist house and engineering office. The base stations for channels 1, 2 and 3 were installed in an unused shower room in the office building. A trailer (shown on page 20) was positioned near the portal as the radio system Project Leader's shop and office.

An order for additional items to complete the system was issued to Motorola Communications & Electronics, Inc. The channel 3 signal strength fade margins were measured on the slope car as it descended in the slope and were found to be greater than required for 20 dB squelched carrier quieting except at the end of the track in the slope.

### 3.2 June 1979

All back ordered equipment for the Phase I purchase order was received and purchase orders were issued for three additional radios. Minor improvements were made in the slope radio system as a result of operating experience. Two radio installations were made in mine vehicles, a loader, and a dump truck. The first back bone cable was installed in the slope. Two base stations and multiplexing equipment were installed in three gasketed weather-proof enclosures (shown on Figure 3.1) near the loading area at the base of the slope. This area was flooded after a rainstorm so the equipment was moved to a higher location. The high water marks can be seen near the bottom of the cabinets, however no water entered the cabinets, and the equipment was not damaged.



FIGURE 3.1. INITIAL INSTALLATION OF MULTIPLEXING EQUIPMENT AND BASE AND CONTROL STATIONS AT THE BASE OF THE SLOPE.



A survey was made of five locations where CCTV cameras are needed to view transitions of the rock conveyor belts and equipment purchasing was initiated.

As part of the preliminary work to design and provide an environmental monitoring system in the mine, Bureau of Mine personnel conducted measurements of the levels of carbon dioxide (CO<sub>2</sub>), hydrogen sulfide (H<sub>2</sub>S), oxygen (O<sub>2</sub>) and particulate matter from diesel exhausts and smoke. A pneumatic sampling system using Vynal tubing to carry the gas samples to the monitoring equipment was proposed. During June 1979, Mr. James C. Cawley became TPO for this project.

### 3.3 July-August 1979

During the months of July and August, radio equipment was installed in all vehicles except the scaler, the repeaters near the slope and crusher no. 3 and their associated distributed antennas were installed, and one leg of the back bone cable was installed down the slope and through the mine. The back bone cable system was completed except for the cable down the air shaft and operating signal levels of the multiplexers were adjusted. Signal strength margins were measured in the mine from the channel 1 repeater which feeds the distributed antenna system that extends into the mine from the bottom of the slope. A signal strength chart along the principal haulage routes and travel roads was prepared on a mine map from these measurements. These measurements proved that the distributed antenna concept is sound and that coverage along the principal roads in the center of the mine is approximately as predicted although signal strengths were not adequate in active mining areas along the perimeter of the mine.

The original reflector at 130W and 205S produced a very noticeable enhancement of the signal in the intersecting crosscut 130E and 130W. The measurements verified some of the measurements that were made in 1977 when the reflector was first tested.

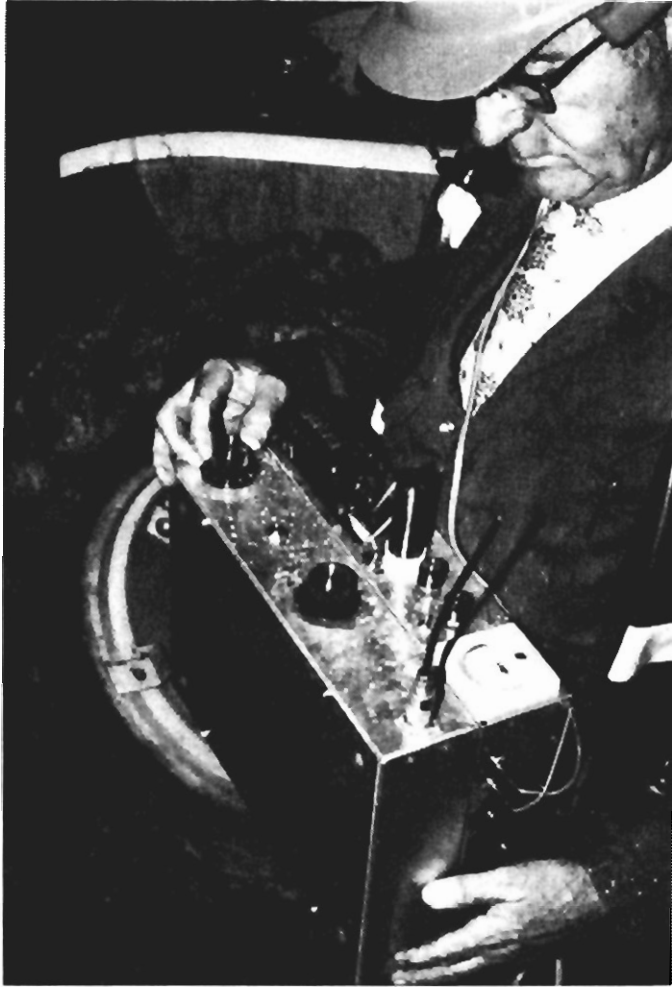

FIGURE 3.2A  
PORTABLE SIGNAL MARGIN MEASURING EQUIPMENT

The equipment used for measuring the signal strength or fade margins weighs less than twelve pounds and it can be supported by a shoulder harness. This equipment substantially reduced the time required for taking signal strength measurements and for tabulating the data. This development probably will be remembered as a major improvement of the technology of signal strength measurements.

The signal margin measuring set was constructed in two 10" x 14" x 3" aluminum chassis which are bolted back-to-back forming a shielded compartment for a portable receiver and two attenuators (0-70 dB and 0-10 dB) which are in series with the antenna lead. The unquelled audio is adjusted to 0dB on a VU meter and is mixed into the head set and tape recorder. The head set microphone audio also is mixed into the tape recorder input so voice recordings of location, data, etc., can be made. See Figure 3.5.



FIGURE 3.2B  
BACK VIEW OF SHOULDER HARNESS  
SHOWING ATTACHMENT TO BELT STRAP  
WHICH RELIEVES PRESSURE ON NECK.



FIGURE 3.3 SIGNAL MARGIN MEASURING EQUIPMENT BEING USED IN A PICKUP TRUCK.

Signal strength fade margin measurements with respect to 20 dB carrier squelch quieting (20 dBq) were made on all haulage and travel roads in the mine in approximately two hours. The driver of the pick up truck read the coordinates of the East-West and North-South crosscuts and the Project Leader repeated into the headset microphone of the tape recorder the coordinates and the attenuator settings which were required to attain a median reading of -20 on the dB meter. The audio level of the unsquelched portable radio that was being used to receive the signal was initially adjusted to 0 dB on the meter. During the tests, the carrier of the base station that was being used was continuously keyed. Later, the signal margins were marked on the mine map, Figure 3.4, in less than three hours. This method of signal strength mapping is fast, inexpensive and repeated measurements produce similar results.

A more sophisticated signal margin set is being developed which will automatically adjust, in two dB increments, a 0-120 dB attenuator connected in series with receiver's antenna lead and the amount of attenuation required for 20 dBq will be automatically printed by a small paper tape printer.

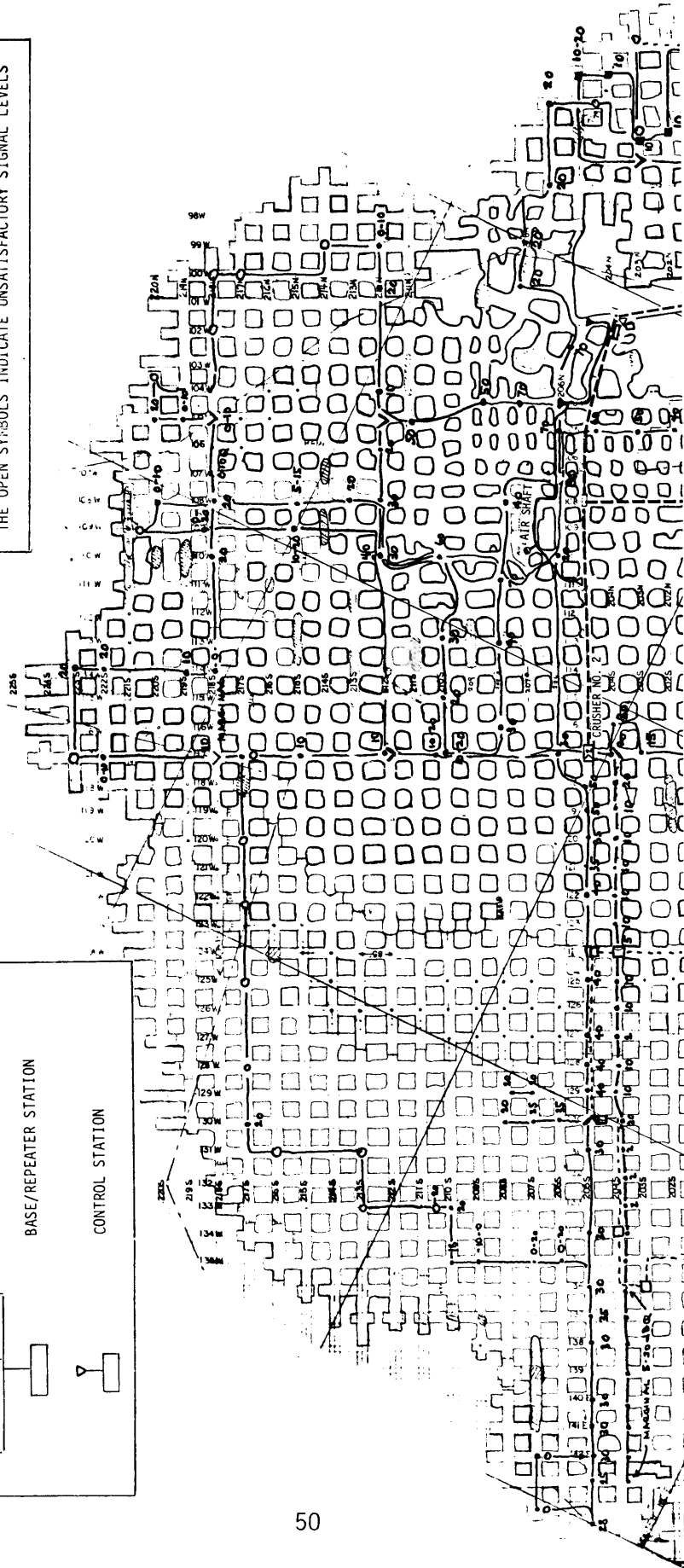
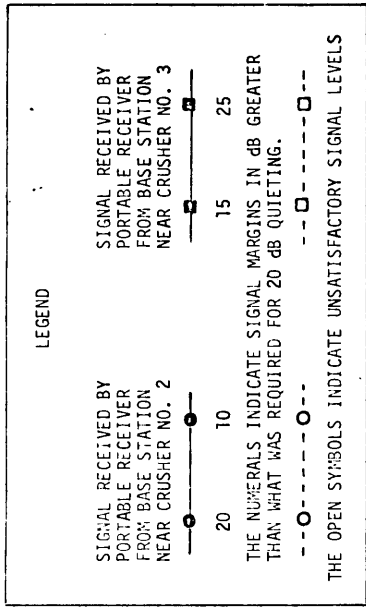
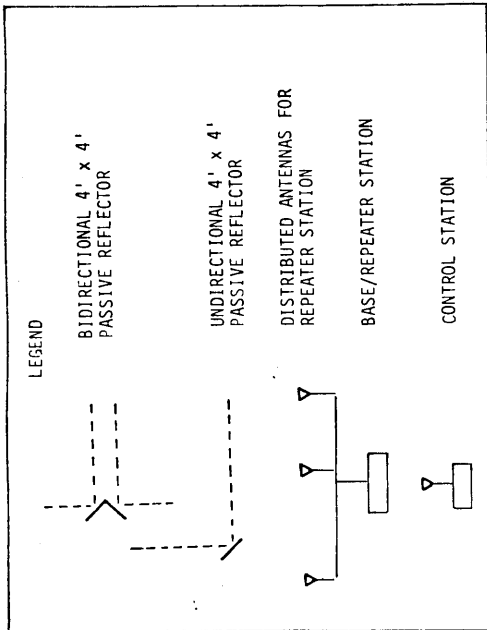

FIGURE 3.4A  
SIGNAL MARGIN MEASUREMENTS MADE IN THE WESTERN HALF OF THE MINE, NOVEMBER 1979.

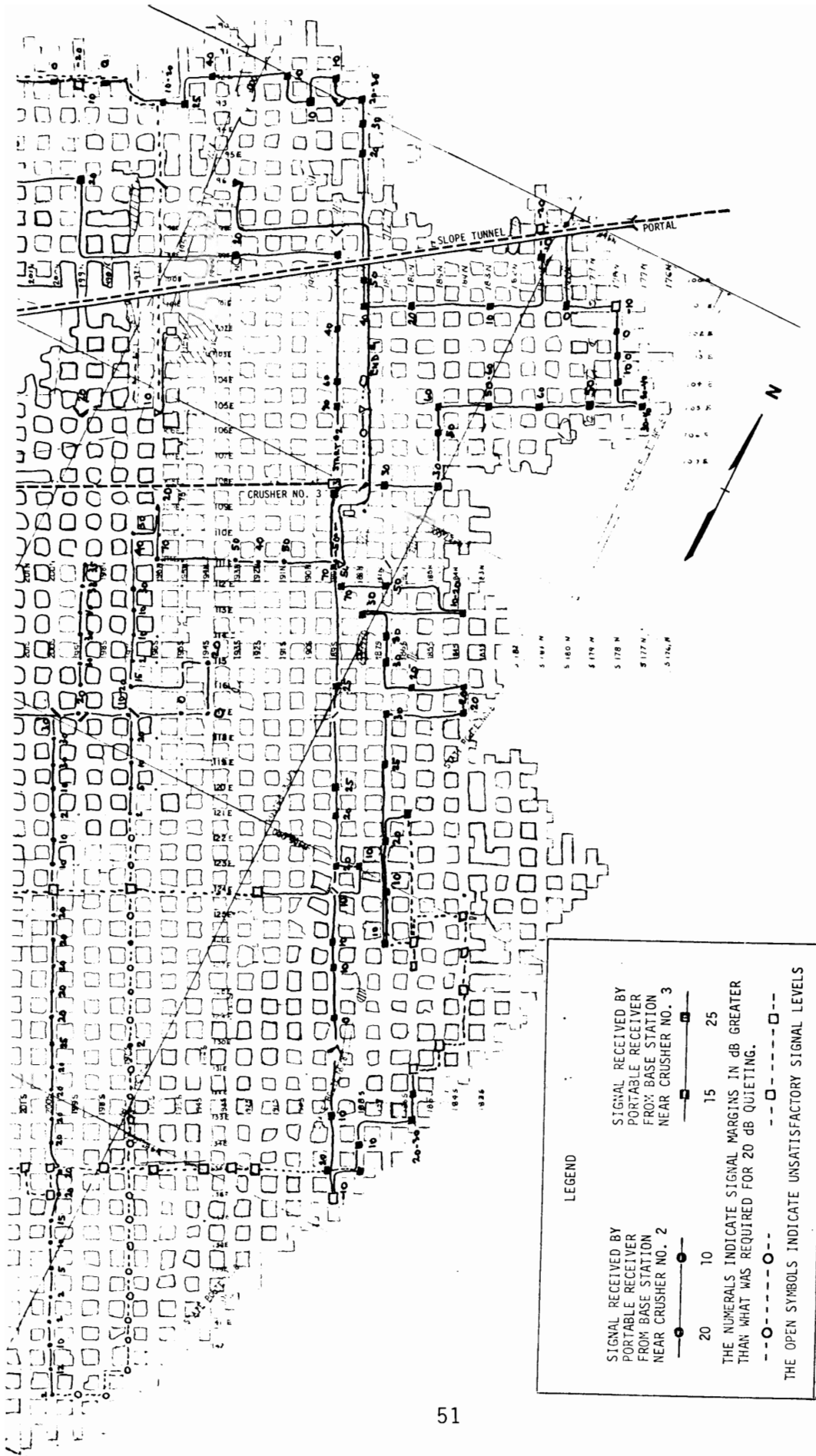

FIGURE 3.4B  
 SIGNAL MARGIN MEASUREMENTS MADE IN THE EASTERN HALF OF THE MINE, NOVEMBER 1979.

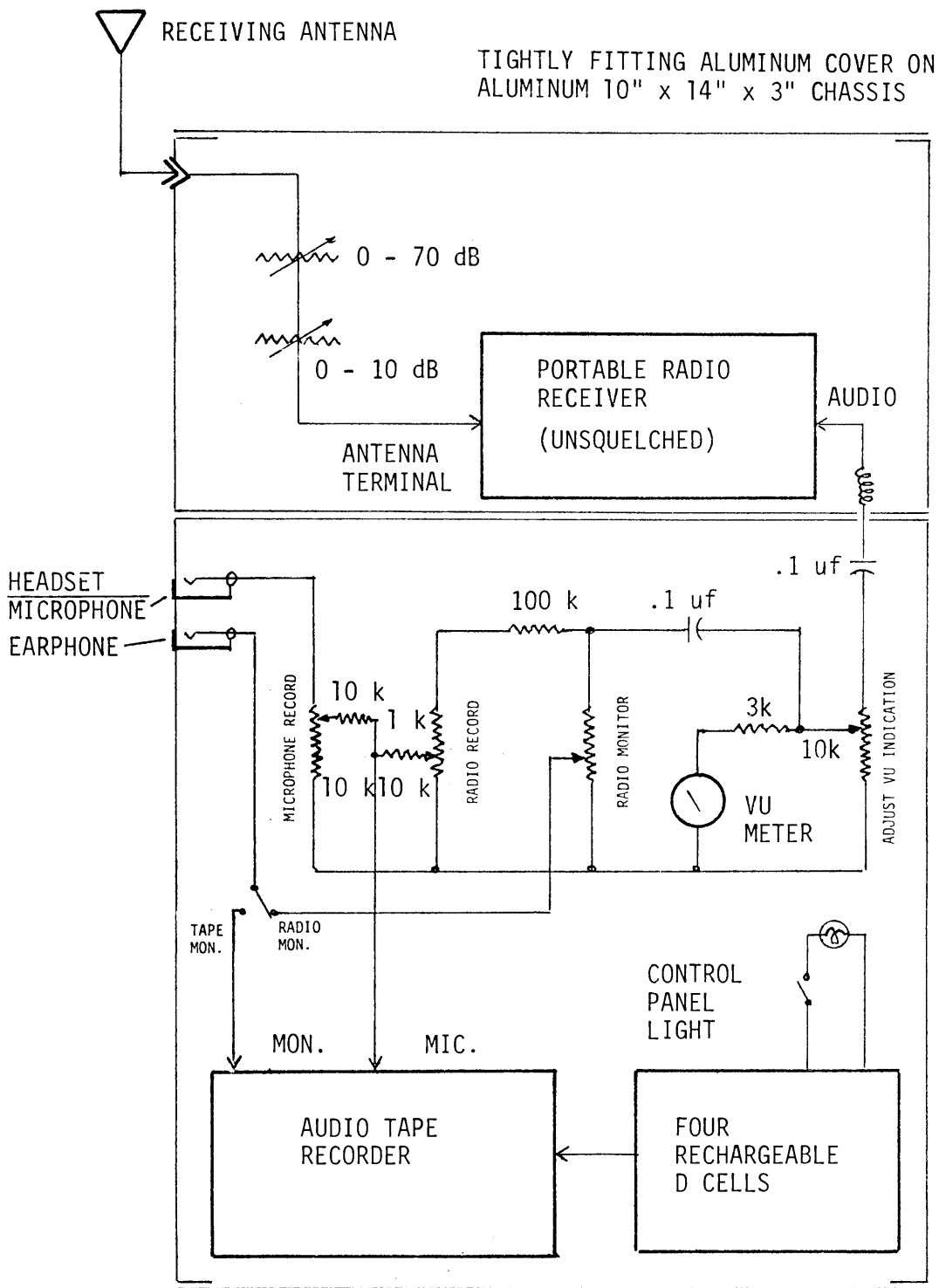

FIGURE 3.5. SCHEMATIC DIAGRAM OF SIGNAL MARGIN MEASURING EQUIPMENT

The proposed signal margin measuring set will read the signal margin above a preset level every five seconds, which is about every twenty feet while walking, or forty four feet when traveling 10 miles per hour.

On August 22, 1979, a demonstration was made to representatives of the Bureau of Mines, the Mine Safety and Health Administration field office, and employees of the Black River Mine to prove that three UHF mobile and three portable transceivers can be operated simultaneously near a face that is loaded with electrical blasting caps. These tests are described in Section 4.0 of this report and also in an MSHA report.<sup>10,11</sup>

The Bureau of Mines ordered a prefabricated room which was installed near the air shaft for housing monitoring and the radio equipment that was removed from the base of the slope where it had been vulnerable to flooding.

### 3.5 September 1979

The Project Coordinator and the TPO visited the mine, reviewed the status of Phase I radio system implementation and conducted an inventory of items furnished by the Bureau of Mines.

Approximately 80% of the radio installation work had been completed. Radios had been installed in ten vehicles but the MODAT status and alarm modules had not been installed. Four radios had not been installed in vehicles which were scheduled to be equipped. Interface units for the MODAT digital encoders which will automatically transmit hot engine, bed up and bed down status messages had to be designed and constructed. Radio channel 1 was operating throughout the mine and channel 3 was operating in the slope. Channel 2 was not operating at the time of the inspection because some of the multiplexing interface equipment had not arrived.

- (10) Report No. M092479 "RF Hazards to Electrical Blasting Caps at Black River Mine", MSHA, Mine Electrical Systems Branch, 4800 Forbes Avenue, Pittsburgh, PA 15213.
- (11) IME Publication No. 20, Safety Guide for the Prevention of Radio Frequency Radiation Hazards in the Use of Blasting Caps, Institute of Makers of Explosives, 420 Lexington Ave., New York, N.Y. 10017.

Although the base station equipment near the base of the slope had been moved to a higher location, it was still vulnerable to flooding and damage from vehicles. Also technicians working on the equipment were vulnerable to electrical shock when the ground is wet. Improvements of the antenna system in the slope still were needed. The Yagi antennas in the slope were coated by moist limestone dust and smoke and the hard hat antenna on the slope car was covered by moist gravel and was inefficient. The brake alarm signal on the slope car had not been perfected. A portable transceiver was needed by the person stationed at the power station at the middle of the slope. A loudspeaker and amplifier was needed for the control station at the bottom of the slope. The signals from the channel 3 repeater station that was near crusher No. 3 did not penetrate the metal clad trailer offices in the new shop area. This was corrected by extending the transmission line from the distributed antenna system in crosscut 188N and an antenna was installed in the shop area. A general emergency alarm signal also was needed in the shop area. Instruction posters were needed for informing mine personnel regarding proper radio procedures.

### 3.6 October 1979

Conferences were held at the Pittsburgh Research Center to review the status of the project and plans for Phase II monitoring systems with the TPO, Project Leader, the Principal Administrator and the Environmental Monitoring Engineer.

During these conferences, the concept for adding multiplexed digital alarm and monitoring signals on the redundant back bone cable system was approved. This deleted the requirement for multipair shielded cable through the air shaft. Mine safety regulations require environmental monitoring equipment to be powered by an uninterruptible power supply (UPS) that will sustain operations during a four hour power outage.

In order to furnish uninterruptible power to the monitoring equipment, a pair of number 8 conductors was ordered to be installed from a 480 volt transformer on the surface to a prefabricated monitoring room in crosscut 111E between crosscuts 205S and 206S.



This power line will bring power from a source on the surface that is independent of mine power circuits to feed an uninterruptible battery supported AC power supply (UPS) in the monitoring room to power the pumps, accensors, and other vital equipment required for monitoring environmental conditions, fire alarms, and future indicators which the mine may require.

Two Deltec model 5247 3 KVA non-redundant UPS will be installed, one in the mine's monitoring room and the other in the sub-station building above ground. Each system will consist of a phase controlled SCR rectifier/battery charger with automatic voltage and current controls, a 125 volt 100 ampere hour Lead Calcium storage battery bank, a dc/ac static inverter with a ferroresonant output transformer, automatic transfer switch from UPS power line (and vice versa) metering panel for frequency, ac and dc volts and amperes, manual bypass switch, protective circuit breakers and provisions for external monitoring and alarms. In the event that the AC mains supply fails, the inverter will be furnished power by the 125 volt batteries which have enough capacity to furnish 3 KVA for at least four hours.

If a current overload occurs (such as high inrush current to a motor that is starting), the automatic transfer switch will transfer the load to the ac bypass power line until the overload condition ends.

Two additional power lines also will be required. One line from the monitoring room UPS will serve the radio control station at the loading dock at the base of the slope. The other line from the UPS in the radio room above ground will serve the radio control console in the hoist house. Power circuits for the control and alarm equipment in the engineering office above ground also will be revised and connected to the UPS in the radio room.

Approximately 75% of the passive reflectors specified for the underground antenna system had been installed and a dramatic improvement in signal strengths and reliability of radio communications was noted.

Mobile radios for mine vehicles were not initially ordered with crystals for "talk around" short range mobile to mobile communications.

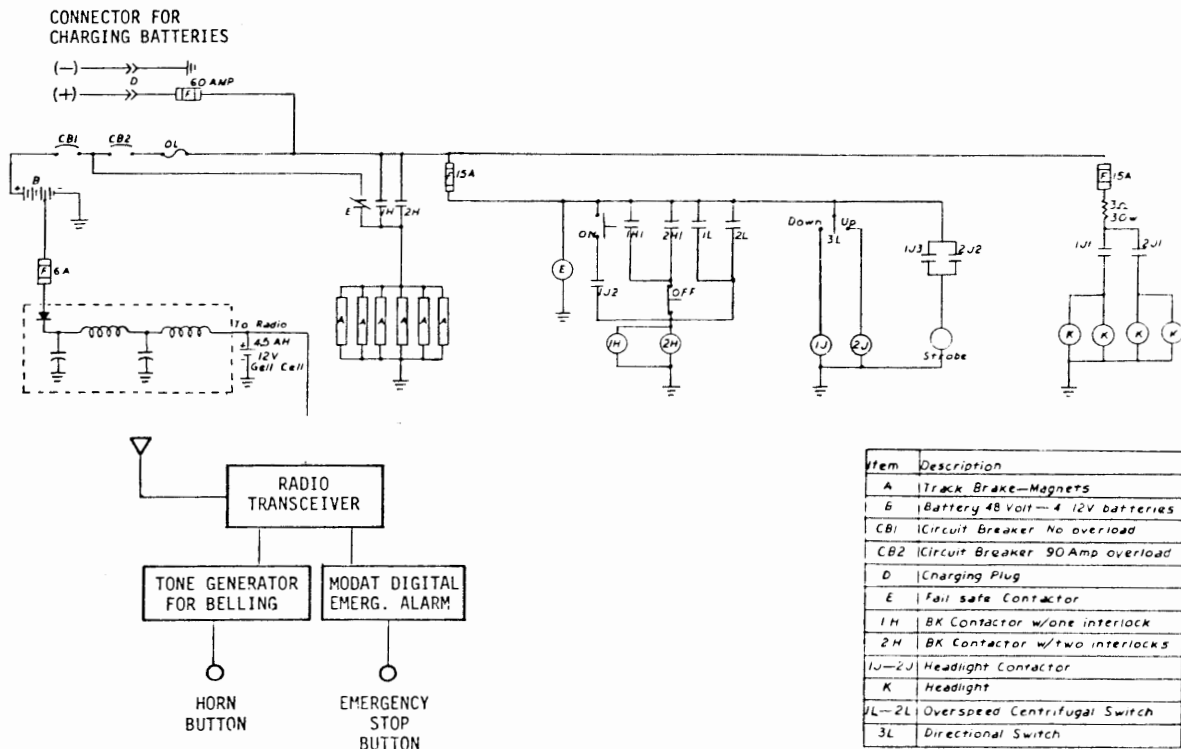
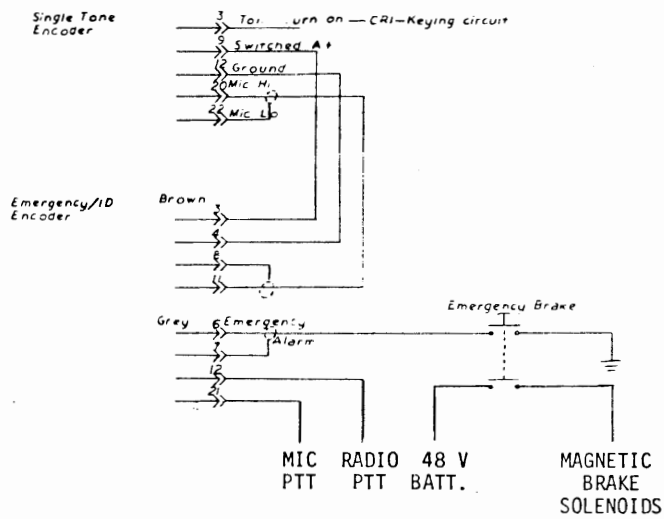

FIGURE 3.6. SCHEMATIC OF SLOPE CAR POWER CIRCUITS

MODAT & SINGLE TONE INTERCABLING



EMERGENCY ALARM CIRCUIT

When the Emergency Stop Button is depressed, a digital alarm signal is transmitted by the MODAT encoder.

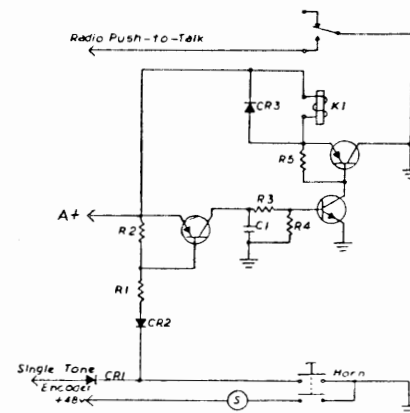

BELLING CIRCUIT

When the Horn button is pulsed, Relay K1 is energized & remains energized for 1 second after the Horn button is released. The delay is determined by C1, R3 & R4.

FIGURE 3.7. SCHEMATIC DIAGRAM OF SLOPE CAR SIGNALING AND ALARM CIRCUITS.

This feature was desired on both channels 1 and 2. Therefore, two sets of crystals for each of the thirteen mobile radios were purchased and installed.

The radio installation on the slope car was extensively revised by the Project Leader after the following problems occurred:

1. A 48/12v dc converter which supplied power for the radio was subject to damage by high voltage transients when the magnetic brakes were operated.
2. A power failure occurred in the mine, and shortly thereafter, power on the surface also failed. The slope car was underway in the slope when the power failed on the surface which caused the car's battery operated magnetic brakes to be automatically energized. After fifteen minutes, the batteries on the car were discharged and would no longer supply power to the radio.

Both problems were corrected, as shown on Figure 3.6, by eliminating the 48/12 volt converter and tapping the slope car battery at 12V to power the radio through a series diode. A Gel/Cel battery was provided, having enough capacity to power the radio for several hours should the car's battery become discharged.

The radio equipment including the tone encoder for horn signaling and MODAT emergency alarm unit were remounted in a NEMA Class IV enclosure to protect them from moisture and falling rock damage.

The horn signaling circuit includes a time delay relay which energizes the horn for a minimum of one second each time that the signal button is pressed. The schematic diagrams of the horn circuit and the MODAT brake alarm signal are shown on Figure 3.7 and the radio control head, horn signal and emergency stop and alarm buttons in the hoist car are shown on Figure 3.8.

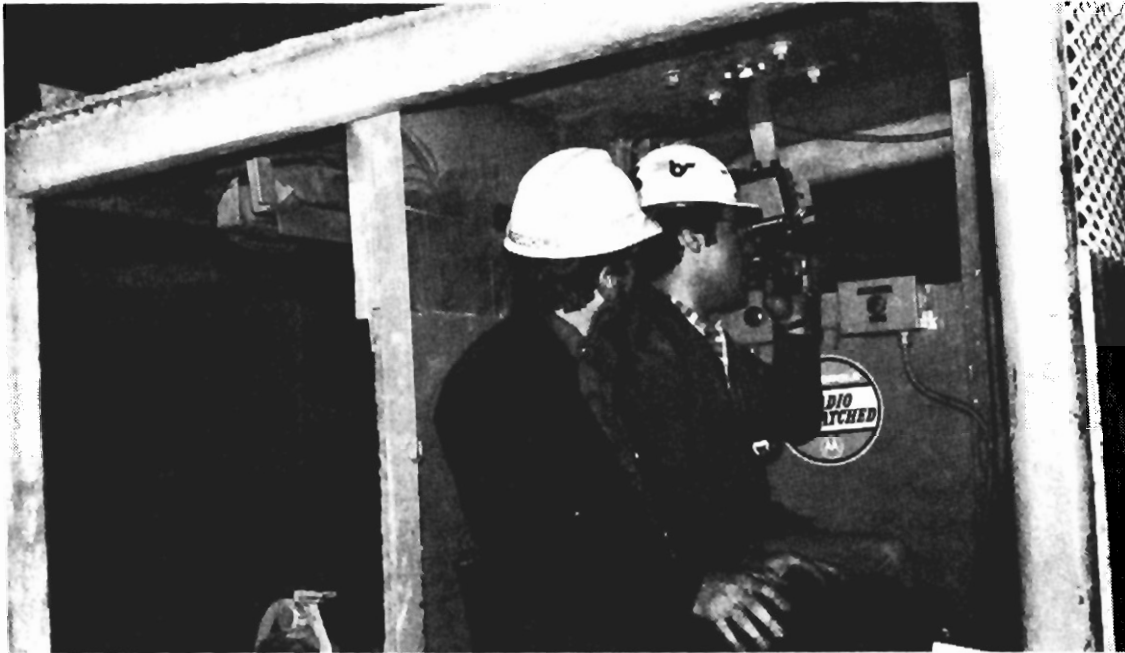

FIGURE 3.8A PASSENGER COMPARTMENT OF SLOPE CAR SHOWING RADIO BEING USED.

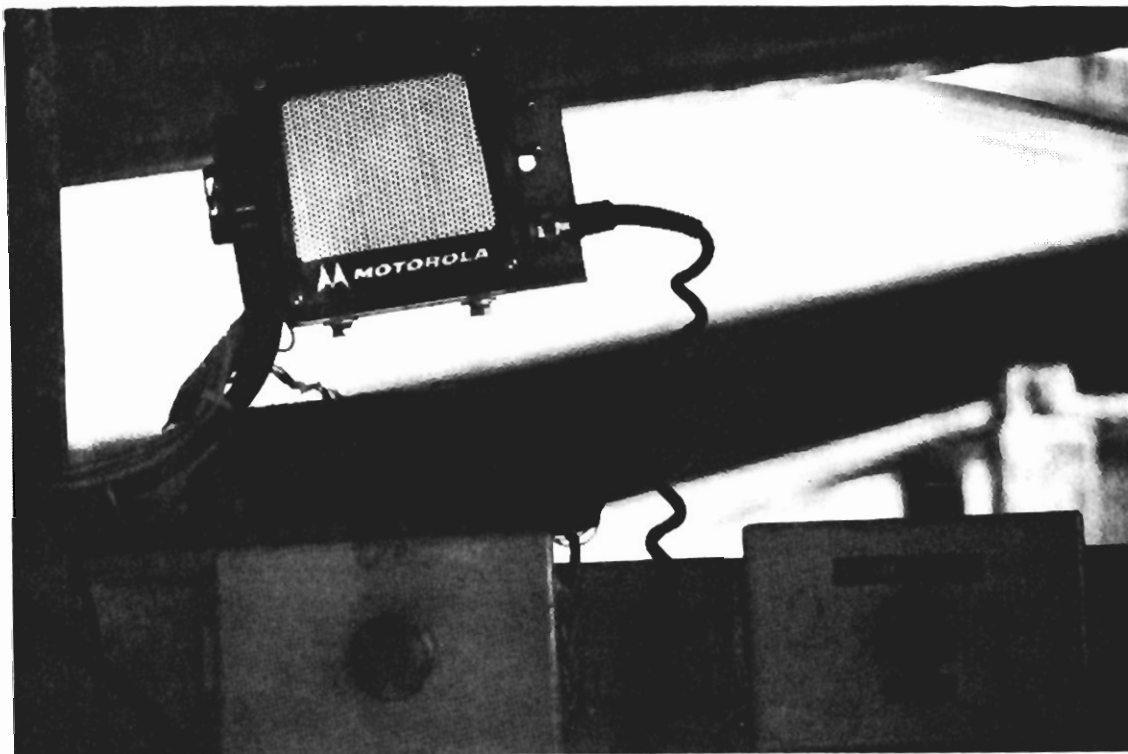

FIGURE 3.8B THE RADIO CONTROL HEAD, HORN SIGNAL AND EMERGENCY STOP BUTTONS ON THE SLOPE CAR.

The slope car radio was initially equipped with a tone encoder for sending an audible signal which is heard in the hoist house. By providing a tone decoder for the channel 3 receiver in the mine and a relay which will close the signal horn contacts, persons on the slope car would be able to activate through radio communication the customary horn signal from the car. The signals would be heard at the base of the slope, mid-slope and in the hoist house. The Project Leader ordered the decoder and other items that were required.

During October Motorola MODAT alarm and status reporting units were installed in nine underground mine vehicles. Two other vehicles plus three new vehicles also are scheduled to be equipped.

As originally installed, alarm signals and status messages could be initiated by push buttons on the MODAT control panels in the vehicles causing audible alarm signals to be heard and alarm and status records to be printed in the mine's engineering office above ground. Tests of this manually operated system have included printing records of the number of loads of limestone rock that are dumped into the crusher. The truck drivers were cooperative and the system functioned satisfactorily. However, in order to avoid human errors and to insure a count each time that a load is dumped, it was decided to install mercury switches on the hand operated levers that causes the truck dump beds to be raised and lowered. The Project Leader and Motorola Engineers undertook the task of designing an interfacing circuit to operate the MODAT for sending status messages including the vehicle number, bed up, bed down and hot engine. Several push button status messages also will be available for assignment.

Mine personnel had developed confidence in the radio system and evidently feel comfortable with the Institute of Makers of Explosives (IME) Safety Guide No. 20 recommendations to not use a UHF radio transmitter with up to 50 watts output power if it is within twenty feet from an exposed blasting cap.

November 1979

When the underground shop was moved a communications center was established in a new foreman's office. The mine requested that emergency alarms on channel 3 (slope car) also should be annunciated in the shop office. As installed, slope car alarms are heard only in the hoist house and in the offices above ground. The mine also requested that emergency alarms received on all three radio channels should activate an emergency siren, having a distinctive sound, which should be installed in the shop area. A radio control unit with a switch for cancelling the emergency alarms was desired outside the office because the office is locked when it is not occupied.



FIGURE 3.9A  
RADIO CONTROL STATION ON THE MINE FOREMAN'S DESK



FIGURE 3.9B  
MODAT ALARM AND MOBILE  
UNIT IDENTIFICATION  
DECODER IN FOREMAN'S  
OFFICE.

### 3.8 December 1979

A history of the project was prepared and was issued in the December 1979 monthly report to the TPO. This report also included data that was collected during the signal propagation tests made in November 1977.

The preliminary report on environmental monitoring was revised to conform with decisions that were made at conferences during November.

### 3.9 January 1980

The major items of closed circuit television equipment, which were ordered during the summer of 1979, and the prefabricated sub-assemblies for the air quality monitoring room were delivered to the mine.

Installation of Vynal tubing for sampling airborne gases and particulate matter was behind schedule due to the lack of man power that could be spared from maintenance work in the mine.

A deficiency in radio communications was discovered in the substation that is half way down the slope. Signals do not reach a working area that is behind the power transformers. A passive signal booster consisting of either a reflector or two high gain Yagi antennas connected together will be installed in an effort to improve communications.

The Project Engineer submitted a proposal to the TPO to design and construct two way multi-channel signal boosters in conjunction with long transmission lines and distributed antennas to solve the problem of communicating with miners at the perimeter of the mine. This system could be extended indefinitely as the perimeter of the mine is enlarged. A preliminary patent disclosure was submitted to the TPO since this concept might be patentable.

Mr. Henry Kramer joined Comsul Ltd., and was assigned as Assistant Project Coordinator for this contract. He will assist Mr. Donald Parrish, Project Coordinator.

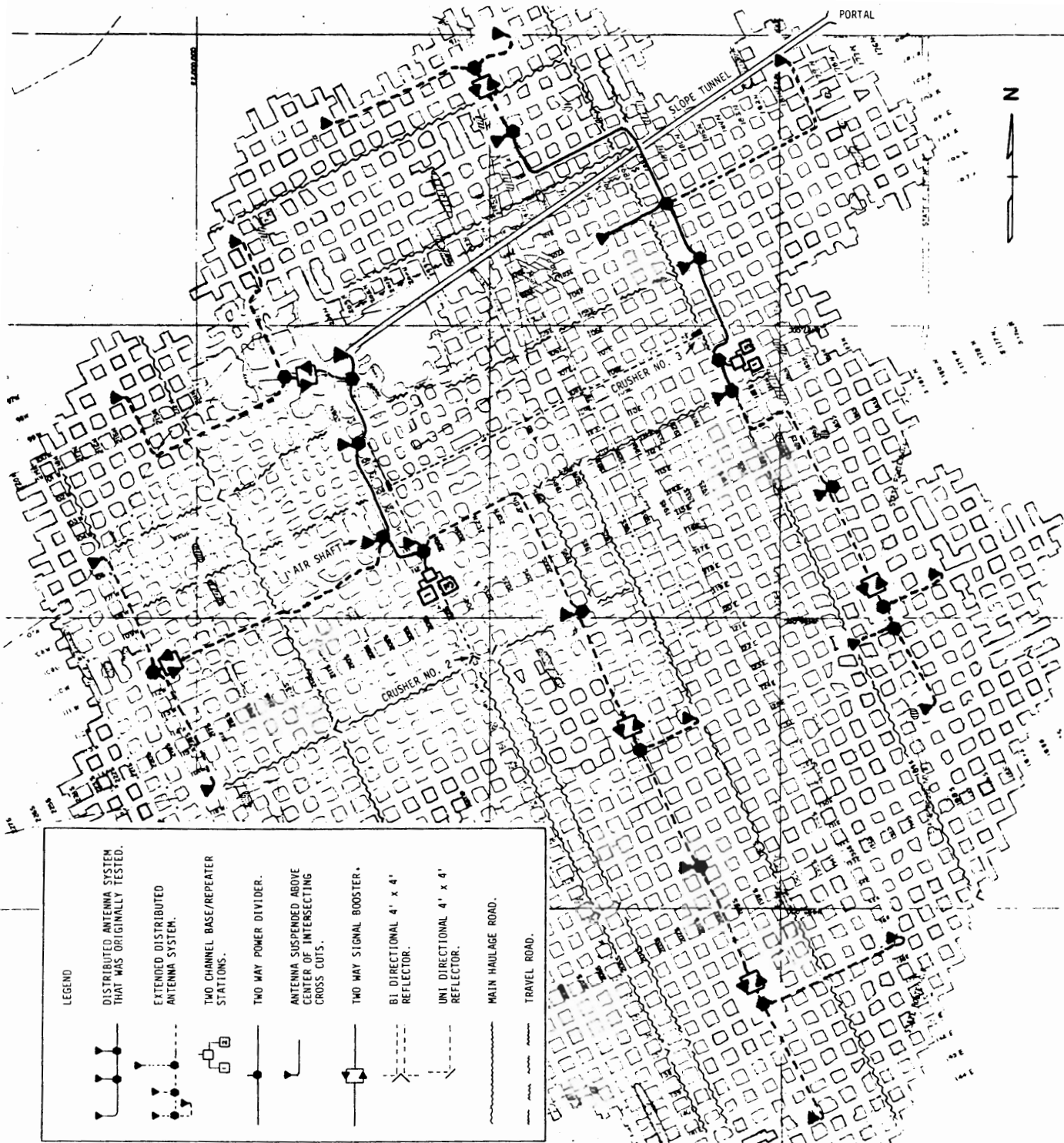

FIGURE 3.10. MAP OF BLACK RIVER MINE SHOWING EXTENDED ANTENNA SYSTEM AND LOCATIONS OF FUTURE SIGNAL BOOSTERS.



### 3.10 February 1980

A complete patent disclosure for the signal booster concept was prepared and submitted to the TPO.

### 3.11 March 1980

In order to expedite and coordinate the installation of the air sampling tube bundles, the redundant back bone coaxial cable, the CCTV system, added antennas and signal booster system and other items, a two day conference was held at the mine. Representatives from the Mine, the TPO, the Project Leader and the Project Coordinators and Engineer from Comsul Ltd., participated in the conference. A GANTT chart listing fifteen tasks was prepared which shows tasks to be completed, their priorities, schedule for completion and list of those who are responsible for completing them.

As an aid for training mine personnel regarding radio operating procedures, a poster was prepared by Comsul Ltd. The mine management approved it and authorized it to be displayed on bulletin boards in locker and lunch rooms.

Preliminary plans were prepared for two distributed antenna systems with two way signal boosters. One system will extend UHF radio communication along the Southeastern and Northeastern areas of the mine and the other will cover the Southern, Western and Northwestern areas as shown on Figure 3.10.

Electronic parts for constructing a prototype of a two way signal booster also were ordered.

### 3.12 April 1980

Henry Kramer of Comsul Ltd. was appointed Project Manager and he conducted a complete inventory of all Government furnished equipment and materials for the radio, CCTV and monitoring projects at the Black River Mine. He also developed new receiving report and purchase order forms for simplifying and improving financial records.



FIGURE 3.11.A PROTOTYPE TWO WAY UHF SIGNAL BOOSTER IN NEMA CLASS 4 ENCLOSURE

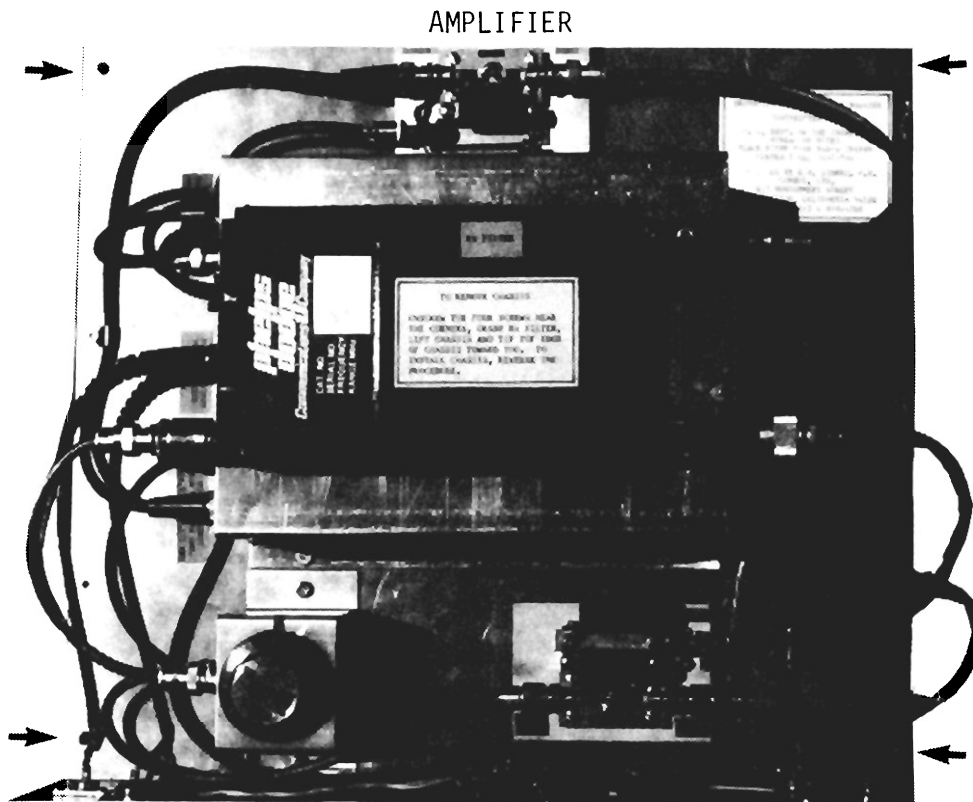

FIGURE 3.11.B CHASSIS FOR PROTOTYPE TWO WAY SIGNAL BOOSTER

### 3.13 May - June 1980

Technical Acceptance Criteria for the radio system was prepared by the Project Engineer and was submitted to the TPO for comments.

The prototype signal booster design and testing continued, new preselectors were installed and the performance was satisfactory. Signal sensing and DC isolation circuits were needed to complete the booster unit. See Figures 3.11 and 3.12.

The monitoring room was erected near crusher No. 2 in the mine and a temporary power line was installed to power air quality monitoring and radio equipment. One of the greatest problems was unsatisfactory automatic answering of the data telephone line. See Figure 3.13.

### 3.14 July 1980

Conferences were held at the mine to determine how much progress was made since the task list was prepared in March, and to coordinate the plans for installing the UPS system and to complete the preliminary report.<sup>13</sup>

### 3.15 August 1980

A pilot installation of the MODAT interface circuit boards was tested on a mine truck. The circuit board functioned satisfactorily, but the proper sensors for bed up, bed down, engine temperature and oil pressure were not on hand.

The need for properly gasketed enclosures (NEMA class 4) for electronic equipment in mines was emphasized by the failure of a CATEL amplifier that had been installed in an ungasketed enclosure. Moisture condensed on the cables, entered the enclosure and collected on its bottom surface. CATEL and Motorola were advised regarding this problem and the Project Leader has modified some gasketed enclosures which are on hand to protect the CATEL equipment, Figure 3.14.

- (13) "Proposed Environmental Monitoring and Uninterruptable Power Systems for the Black River Mine", Comsul Ltd., Preliminary Report to BOM TPO, July 1980.

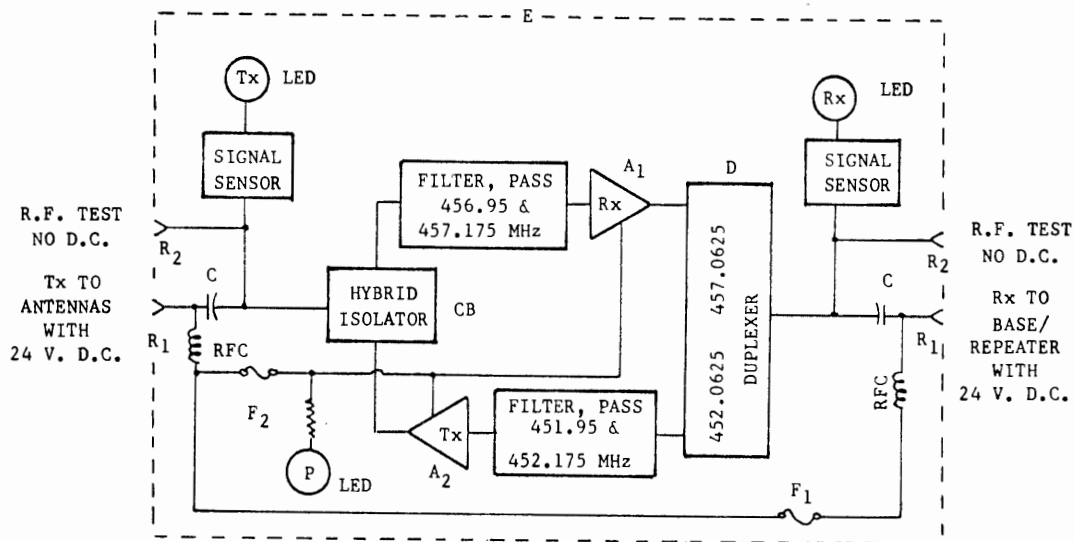

LEGENDS

- A<sub>1</sub>, A<sub>2</sub> TRW CA 2820 Linear Hybrid Amplifiers mounted on TRW TF06 test fixture assemblies.
- D Phelps Dodge mobile duplexer Cat. No. 633-6 for 406 - 470 MHz range.
- Filter Band Pass Filters, Phelps Dodge PD-941 PB4
- C Capacitor, 1000 mmfd, ceramic 100 volt.
- CB Power splitter combiner, 0° phase shift, Mini Circuits Model ZFSC-2-1.
- E NEMA type 4 dust and water proof enclosure.
- F<sub>1</sub>, F<sub>2</sub> Type 3AG fuse and fuse holder.
- LED Tx, Rx Light emitting diode, orange signal indicator.
- P Light emitting diode, green, power "on" indicator.
- R<sub>1</sub> Type N receptacles for transmission lines to other antennas or base station.
- R<sub>2</sub> UHF receptacle for test instruments (isolated from d.c. voltage on center conductor).

FIGURE 3.12. SCHEMATIC DIAGRAM OF PROTOTYPE TWO-WAY UHF RADIO SIGNAL BOOSTER

The signal sensors will make it possible to visually verify that each signal booster is operating by keying a portable or mobile transceiver while observing the LED indicators. A more sophisticated signal sensing circuit could be used which would report deviations from normal signal levels via a pilot carrier to the control center. This type of circuit also could digitally identify the signal booster or boosters having low output. This feature would be useful in large systems having many signal boosters in series. However, the mean time between failure for the CATV hybrid amplifiers is estimated to be twenty years, so the reliability of the system should be adequate.

The CCTV cameras have been very effective for viewing the hoist car at the bottom of the slope and the flow of material at transfer points along the belt conveyor system.

### 3.16 September 1980

The multiplexing system for the air monitoring system was designed and the CATEL modulators and demodulators were ordered by the Environmental Monitoring group at PRC.

An experimental Research license, KK2-XCA was received which authorizes the operation of the signal booster systems in the Black River Mine.

Research on CATV and other signal booster amplifiers continued, and one of the Japanese engineers who prepared a paper describing a signal booster system for highway tunnels in Tokyo was interviewed.<sup>14</sup> The Nippon Telegraph and Telephone Public Corporation has tested a two way 800 MHz signal booster system that is similar in concept to the ones that have been designed for the Black River and Sesser Mines.<sup>15</sup> A C-COR CATV distribution amplifier was tested, it exceeded its published specifications and is suitable for use in mines and tunnels.<sup>16</sup>

The redundant back bone coaxial cable was installed in a bore hole that is near the lime plant.

The coaxial cable for extending the signal booster system to the eastern perimeter of the mine was partially installed and a schedule was prepared for completing the installation of cables and antennas.

The DC to DC inverters on the vehicles that have 24V or higher battery voltages have been quite unreliable and will be removed from service. Since the radios require a small amount of current, they will be connected to twelve volt taps on the batteries.

- (14) Suzuki, Hanazawa & Kozono, "Design of Tunnel Relay System with a Leaky Coaxial Cable in an 800 MHz Land Mobile Telephone System."
- (15) Fisher, Jack, "A Unique Multichannel Two Way UHF Radio Signal Booster System for Leaky Transmission Lines in Mines", IEEE 31st Vehicular Technology Conference, April 1981.
- (16) Isberg, R.A., "Evaluation of C-COR CATV Distribution Amplifier as a Signal Booster for VHF Radio Systems", Comsul Ltd., Report to BOM TPO, September 1980.

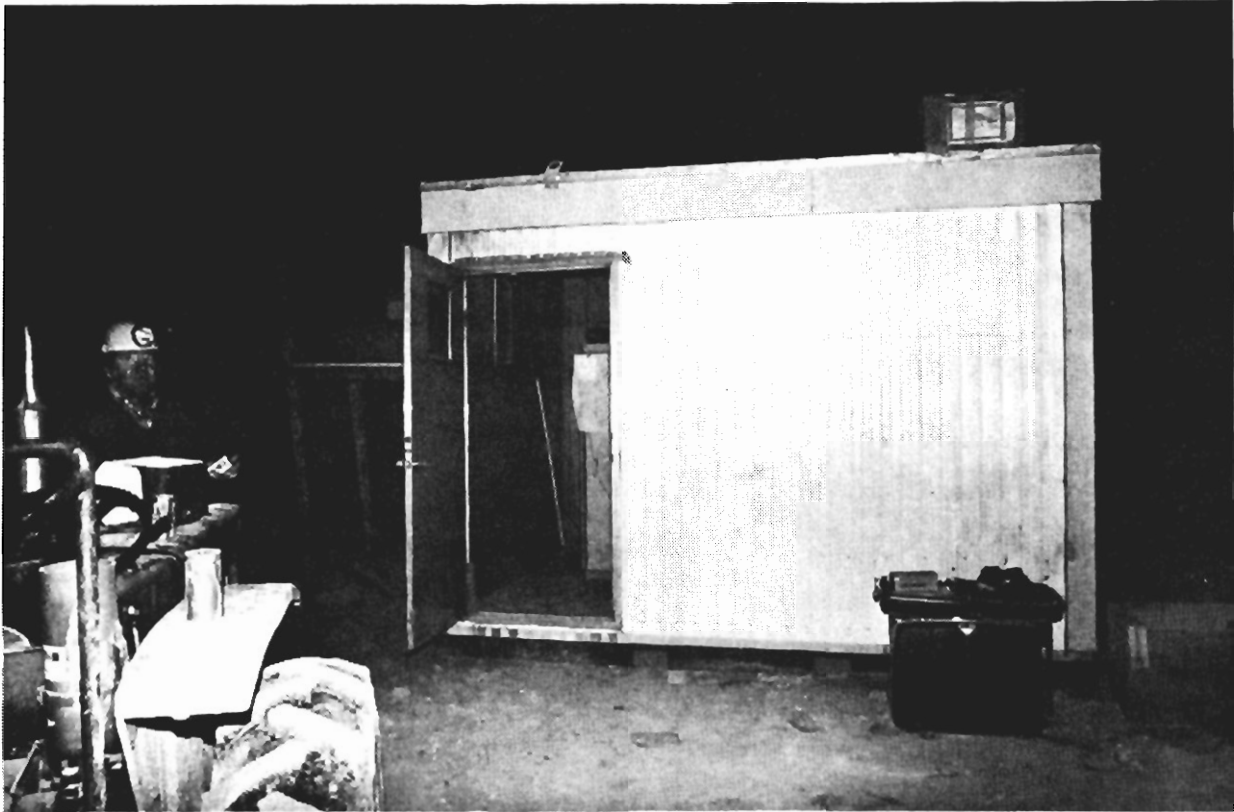

FIGURE 3.13. THE RADIO AND MONITORING EQUIPMENT ROOM IS LOCATED NEAR CRUSHER NO. 2 APPROXIMATELY AT THE CENTER OF THE MINE.

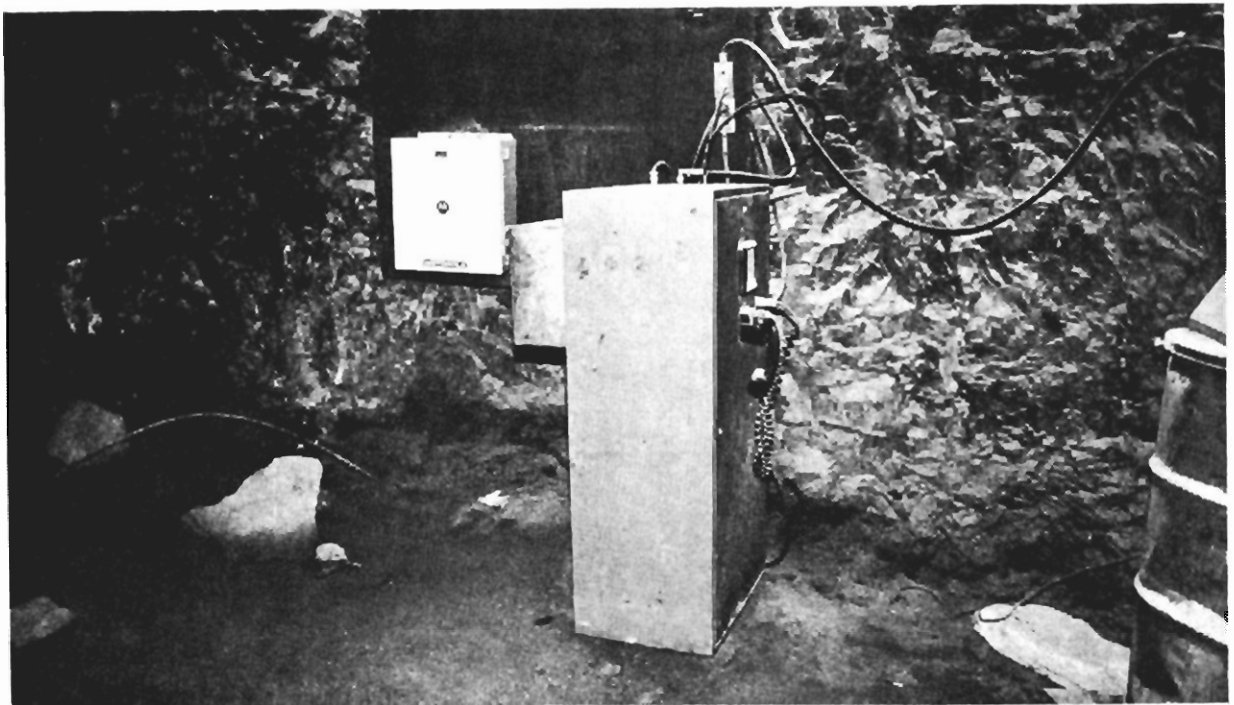

FIGURE 3.14. CONTROL STATION AND MULTIPLEXING EQUIPMENT IN A GASKETED WEATHER-PROOF CABINET IN THE LOADING AREA AT THE BASE OF THE SLOPE. AN EXTENSION WAS ADDED TO A WEATHERPROOF CABINET TO ACCOMODATE THE RACK MOUNTED MULTIPLEXER UNITS. THE CABINET ON THE WALL CONTAINS STORAGE BATTERIES WHICH PROVIDE UN-INTERRUPTIBLE POWER FOR THE MULTIPLEXING EQUIPMENT.

### 3.17 October 1980

Six sets of aluminum chassis and brackets for constructing six UHF two way radio signal boosters were fabricated and one chassis was punched for the first production unit to verify the hole pattern for the latest model.

The hole patterns for the NEMA Signal booster enclosures also were finalized. All receptacles for cables and three LED indicators will be on the bottom side of the enclosures and the cables connecting to the receptacles will form drip loops to prevent condensed moisture from collecting around the receptacles. A compliant gasket will be attached inside the bottom side of the enclosure to seal the areas around the receptacle holes when the chassis is in place. The chassis will be attached by machine screws to the factory installed threaded studs in the enclosures.

A key operated security lock will be installed in the cover of each enclosure and short chains will be attached by rivets to the lower side of the cover and the enclosure. A transparent envelope will be attached to the inner side of the cover and it will contain diagrams, maintenance data and the FCC license.

The enclosures will be mounted on walls in the mine high enough above the floor that they cannot be reached without using a ladder.

The three LED's under the enclosure will be visible to a person walking or riding in a vehicle. One LED will glow indicating when 24 volt power is on, one LED will glow when a signal from the base/repeater is being amplified, one LED will glow when a strong signal from a portable or mobile is being received. An improved signal sensing circuit has been developed and its sensitivity will be adjustable.

Except for small hardware items and some receptacles, sufficient components are on hand to complete three boosters. The other three signal boosters cannot be completed until six TRW test fixtures or socket assemblies for the CA2820 amplifiers have been acquired.

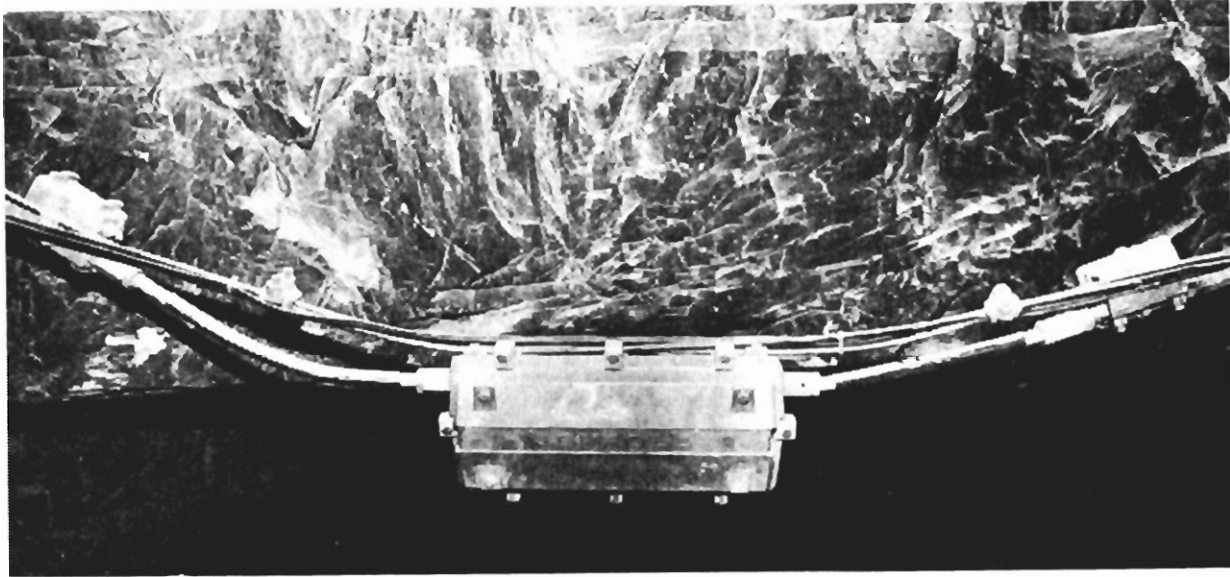

FIGURE 3.15. CATV LINE AMPLIFIERS FOR THE "BACK BONE" COAXIAL CABLE SYSTEM ARE ENCLOSED IN GASKETED WATER TIGHT CAST ALUMINUM HOUSINGS AND ARE SUPPORTED BY STEEL MESSENGER CABLES.



FIGURE 3.16. TV MONITORS AND RADIO CONTROL EQUIPMENT IN THE HOIST HOUSE.



Nearly all of the ten thousand feet of coaxial cable for extending the antenna system in the mine has been installed and several antennas also have been installed. The redundant back bone coaxial cable has been installed from where it enters the mine to the radio base stations located near crusher No. 3.

The CCTV camera that views the slope car loading area at the bottom of the slope was moved in an effort to provide a better view for the hoist operator. After trying it at the new location, it was decided to move it back to the original position and mount it on an adjustable pan tilt head. The pan tilt head that was originally installed under the camera that views the conveyor belt transfer point at the top of the slope has not been needed so it was available for installation underground.

All radio equipment at the Black River Mine is now more than one year old and is out of warranty and it will be necessary to purchase replacement parts when they are needed. The CCTV camera equipment is less than one year old and is still covered by the warranty.

### 3.18 November 1980

The first MODAT interface unit on a mine truck is functioning satisfactorily and the bed up - bed down switch has been replaced by a switch that is actuated by the bed instead of the hand lever. Erroneous indications could be transmitted when the switch was actuated by the hand lever, indications from the switch that is actuated by the position of the bed are accurate and reliable. It will now be practical to equip all mine trucks with the MODAT interface units and proper sensors and switches. See Figure 3.21.

Unexplained problems with radio communications in the slope have been traced to a loose connector in the antenna system of a repeater which eliminated suspected losses due to moist dirt on the antennas.

The antenna above ground was moved to a tower which supports the belt conveyor system (see page 21). This vastly improved communications between persons using transceivers near the air shaft, substation, lime plant and administration building.

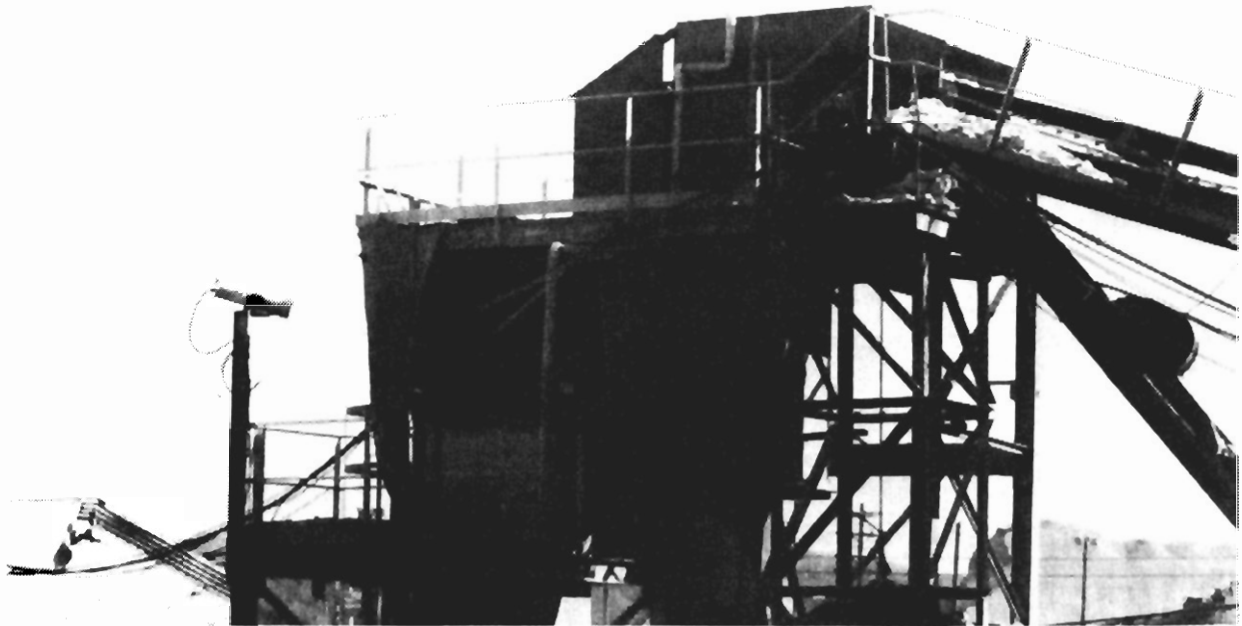

FIGURE 3.17. TV CAMERA VIEWING ROCK MOVEMENT AT THE TRANSITION OF CONVEYOR BELTS ABOVE THE MINE PORTAL.



FIGURE 3.18. TYPICAL RADIO INSTALLATION IN A MINE VEHICLE SHOWING THE MODAT EMERGENCY ALARM, IDENTIFICATION AND STATUS ENCODER UNDER THE ROOF AND THE RADIO CONTROL HEAD MOUNTED ON THE COLUMN.

### 3.19 December 1980

The mine constructed a brattice cloth curtain enclosed area in the eastern sector of the mine for storing ash that is collected from the lime kilns.

The dust is dropped down the "dust hole" into a hopper where it is mixed with high pressure air and blown through a large pipe to the curtained storage area. While no one was in the mine a coupling in the pipe line separated and the dust was blown into the mine. The operator at the lime plant had no indication of the problem which persisted until the first shift reported that the air was so full of dust that they couldn't work.

Since a TV camera can detect large quantities of dust in the air, one of the cameras will be moved to the dust collection area to feed a monitor located in the lime plant control area. The operator will be able to visually monitor the performance of the underground dust storage system and to turn off the machinery when trouble is detected.

A failure of the radio on the slope car was traced to lack of water in the slope car's storage batteries. When water was added the batteries recovered and the radio functioned normally. The mine has ordered vapor condensing battery caps to prevent this type of problem.

### 3.20 January - February 1981

Materials for constructing new alarm annunciator panels for the underground shop, the hoist house and the administration building were obtained. Emergency alarms that are sent from any radio in the system will be annunciated at all three locations. Each of the three annunciator panels can be independently reset.

Over the past several months various types and locations for the truck bed position sensors and actuators have been tried. The most successful arrangement is a normally open switch that is actuated by a stiff piece of rubber that is attached to the truck bed. This arrangement will be installed



FIGURE 3.19. VIEW OF YAGI ANTENNA INSIDE THE PORTAL SHOWING SEVERAL MONTHS' ENCRUSTATION OF LIMESTONE DUST AND SMOKE PARTICLES ON THE ANTENNA RODS. THE ANTENNA VSWR WAS NOT READABLE WITH 2.5 WATTS FORWARD POWER AND PERFORMANCE EVIDENTLY WAS NOT DEGRADED.

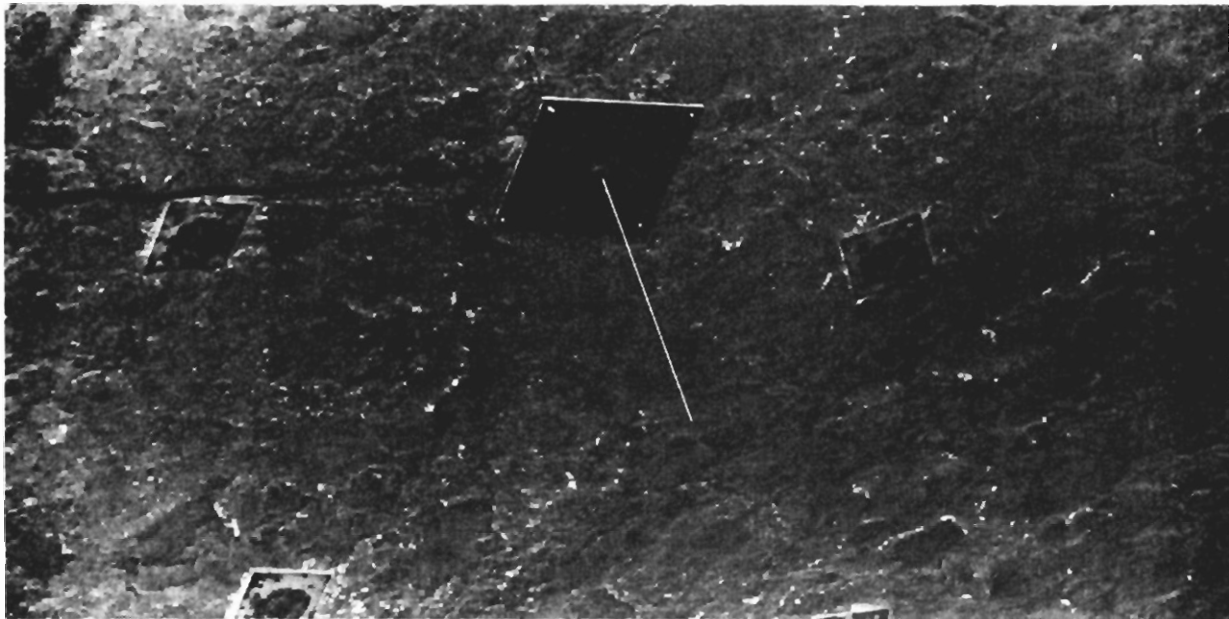

FIGURE 3.20. TYPICAL MOBILE ANTENNA USED FOR DISTRIBUTED ANTENNA SYSTEM MOUNTED ON TWO FOOT SQUARE METAL PLATE THAT IS ATTACHED TO ROOF NEAR THE CENTER OF INTERSECTION OF TWO CROSSCUTS.

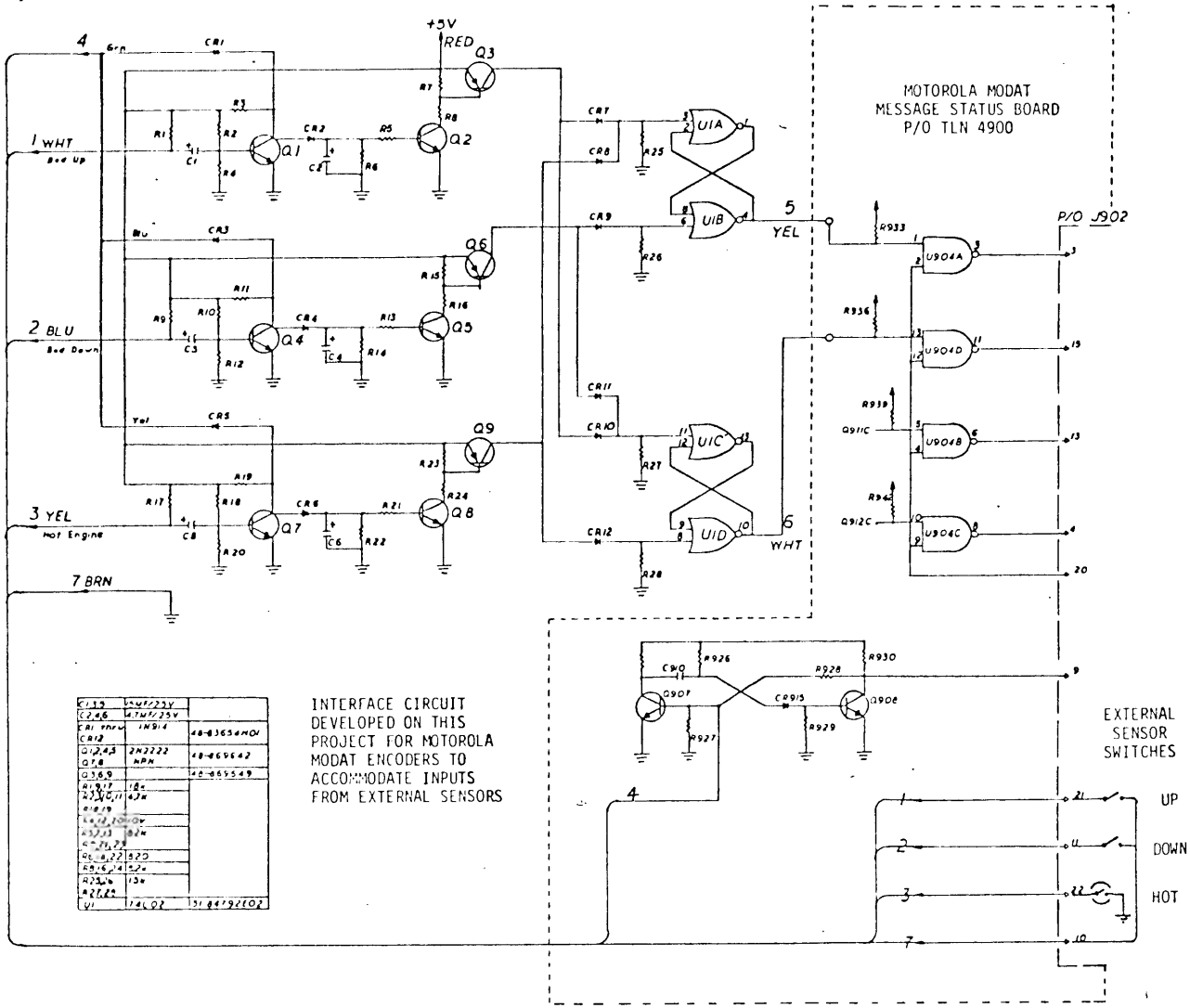

FIGURE 3.21 SCHEMATIC DIAGRAM OF INTERFACE UNIT FOR MOTOROLA MODAT DIGITAL STATUS ENCODER USED ON MINE TRUCKS TO AUTOMATICALLY SEND BED-UP, BED-DOWN, AND HOT ENGINE STATUS MESSAGES FROM EXTERNAL SENSOR SWITCHES.

on all trucks. The mine will furnish engine temperature and oil pressure sensors which also will be connected. The interface unit between the sensor switches and the MODAT encoder operates reliably and its schematic is shown on Figure 3.21.

A major problem in installing radio equipment on mine vehicles is the various types of dc power systems. Figure 3.22 shows three power circuit diagrams for radios on various mine vehicles that were developed by the Project Leader.

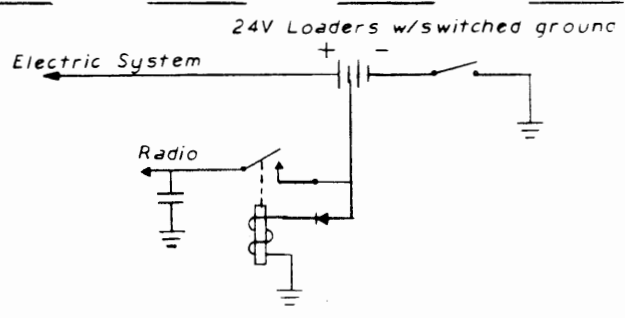
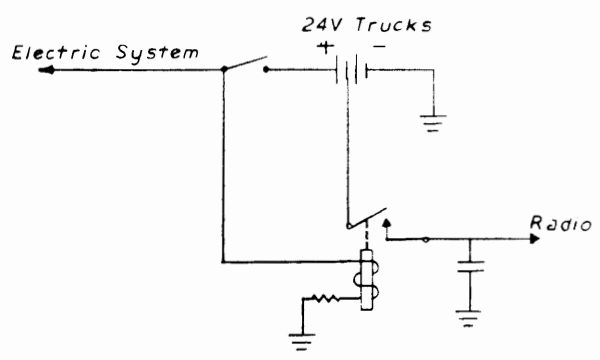
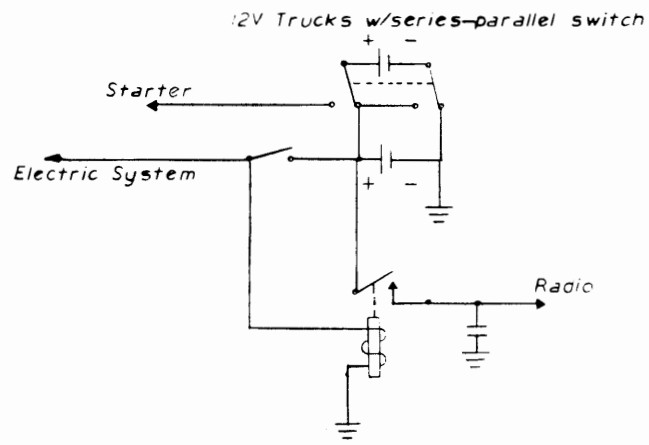

FIGURE 3.22

POWER CIRCUITS FOR MOBILE RADIOS ON MINE VEHICLES

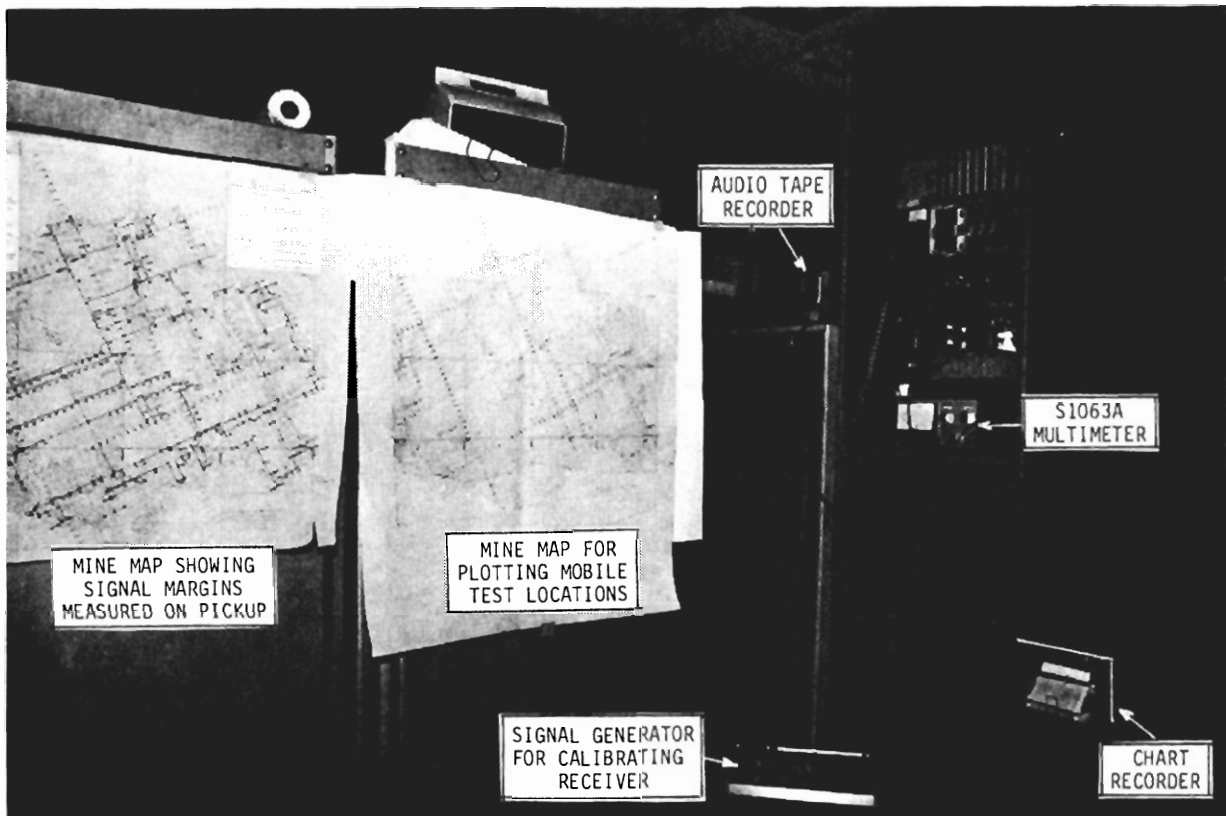

FIGURE 3.23 INTERIOR OF RADIO AND MONITORING EQUIPMENT ROOM SHOWING BASE STATIONS AND TEST EQUIPMENT USED FOR MEASURING SIGNAL MARGINS FROM A HAND HELD TRANSCEIVER.

### 3.21 Inspection and Acceptance Tests of Radio and CCTV Systems

The radio and CCTV systems were inspected by the TPO, Project Manager and Engineer January 28 - 30, 1981. The inventory records were compared with the equipment that is installed and no discrepancies were found.

Signal strengths from a two-watt hand-held transceiver that was operated while driving a tractor were measured at the base stations in the mine. The RF output of the last IF crystal filter in a Motorola Micor receiver was rectified by an RF probe and the dc voltage output (across meter terminals) of a Motorola A1063B Multimeter fed an Esterline Mini Servo chart recorder. This arrangement made it possible to measure signal levels ranging from 1uv to 100uv at the antenna terminal of the receiver. These measurements were later converted to signal levels above 20dB carrier squelch quieting which are plotted on Figures 3.24A and 3.24B and are listed on Tables 2 and 3 in the appendix.

Similar measurements and quality evaluations also were made of transceiver reception above ground and are listed on Table 1 in the Appendix. The measurements generally agreed with those made in November 1979 and confirmed the need for two way signal boosters.

LEGEND

SIGNAL RECEIVED AT  
BASE STATION NEAR  
CRUSHER NO. 2

20 — 10

SIGNAL RECEIVED AT  
BASE STATION NEAR  
CRUSHER NO. 3

15 — 25

THE NUMERALS INDICATE SIGNAL MARGINS GREATER THAN  
REQUIRED FOR 20 dB QUIETING.

THE OPEN SYMBOLS INDICATE UNSATISFACTORY SIGNAL LEVELS.

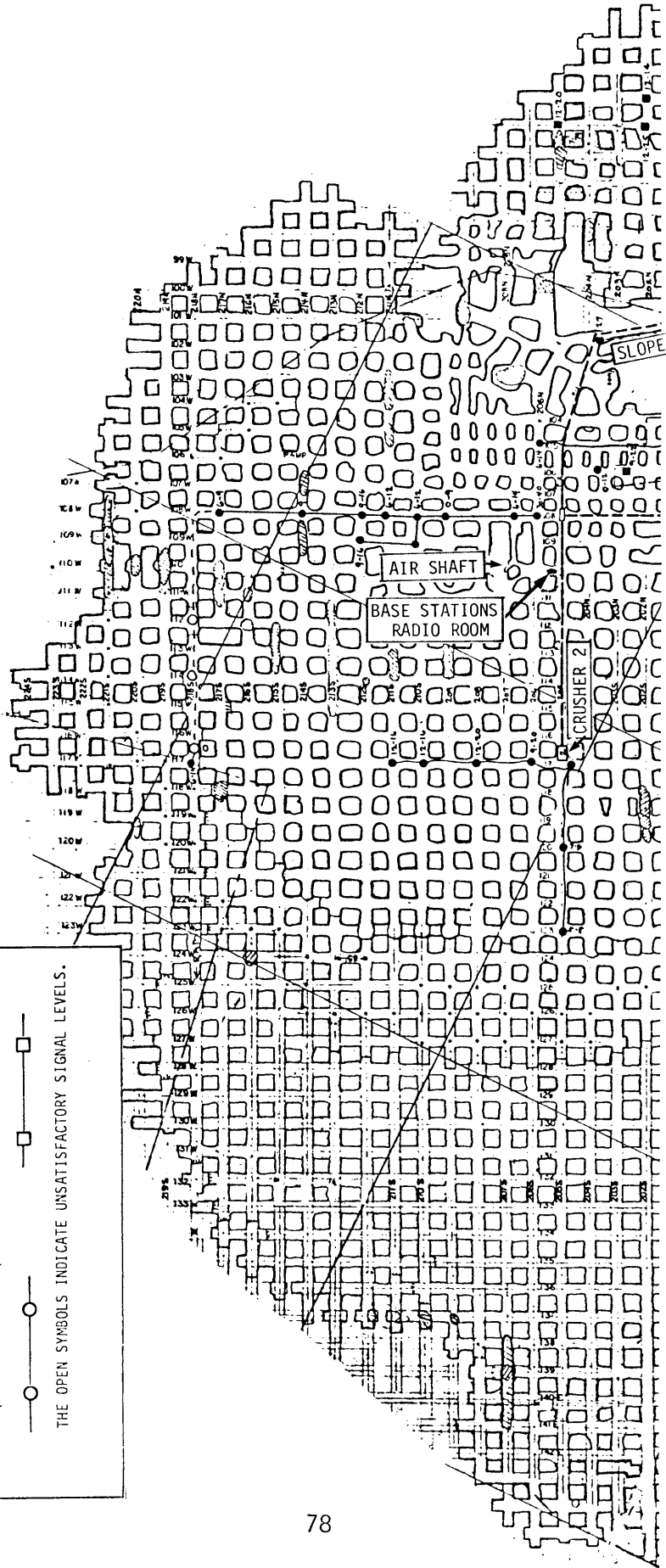

FIGURE 3.24A  
A MINE MAP SHOWING SIGNAL MARGINS ABOVE 20dBq MEASURED AT A BASE STATION IN THE MONITORING BUILDING FROM A  
HAND HELD TWO WATT TRANSMITTER OPERATED ON A VEHICLE IN THE WESTERN SECTOR OF THE MINE. THE SIGNAL AND  
QUALITY EVALUATIONS ARE LISTED ON TABLE 3 IN APPENDIX C.



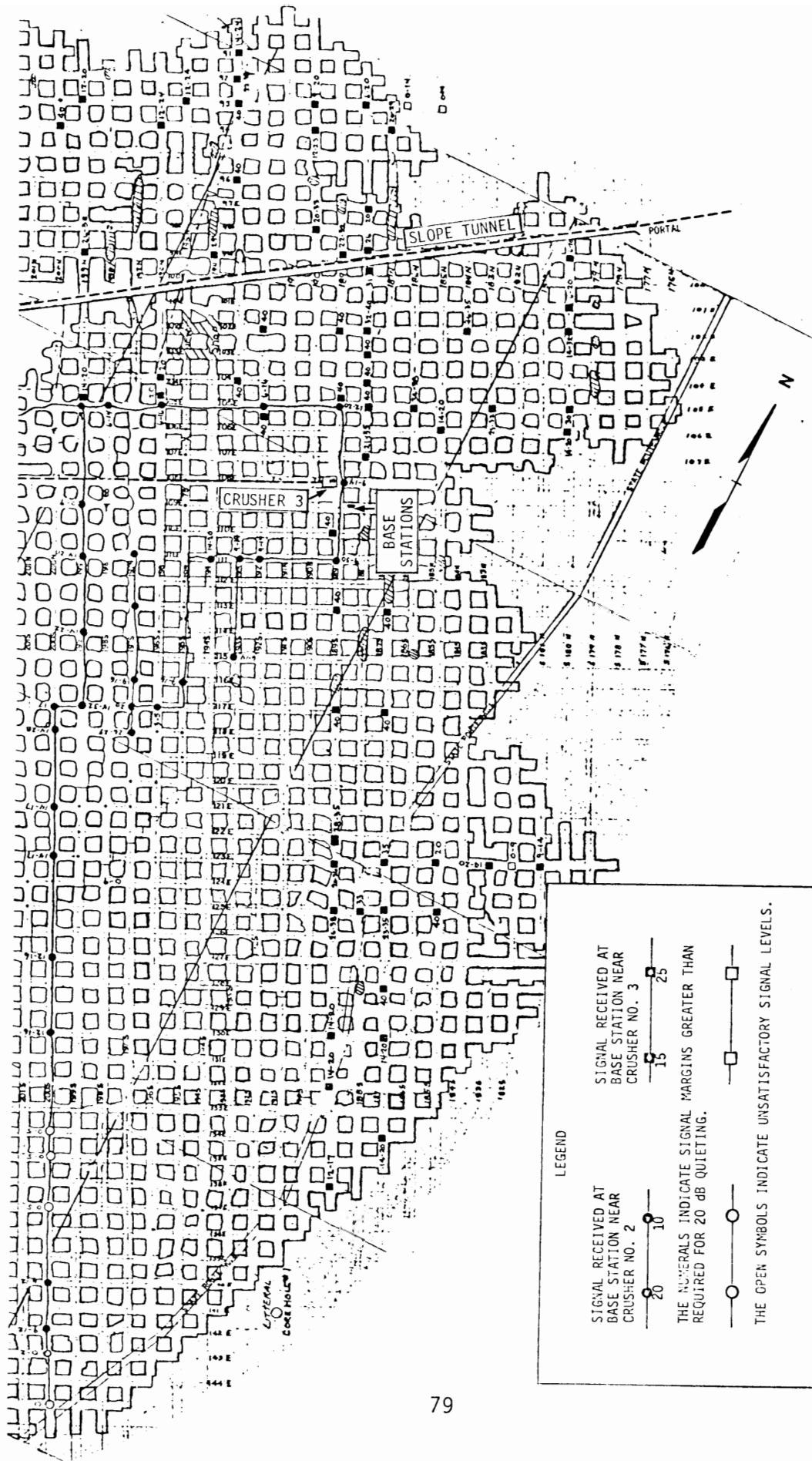

FIGURE 3.24B  
 SIGNAL MARGINS ABOVE 20dBq MEASURED AT A BASE STATION NEAR CRUSHER NO. 3 FROM A HAND HELD TWO WATT TRANSCIVER OPERATED ON A VEHICLE IN THE EASTERN SECTOR OF THE MINE. THE SIGNAL LEVELS AND QUALITY EVALUATIONS ARE LISTED ON TABLE 4 IN APPENDIX C.

### 3.22 As Built Radio System Description

The completed radio system is very similar to the system that was designed in 1978 and which is described in section 2.8 of this report. The principal changes are:

- The base/mobile relay stations which were originally installed near the base of the slope were moved to a prefabricated radio and monitoring room that is near Crusher No. 2.
- The distributed antenna systems have been extended and two-way signal boosters will be installed to extend reliable radio communications to the perimeter of the mine.
- DC-to-DC converters (48 or 24v to 12v) have proven to be unreliable and have been removed. Radios have been connected to 12-volt taps on vehicle storage batteries.
- Experience has demonstrated that all radio equipment in a mine should be installed in NEMA Class 4 or equivalent enclosures and cables should enter cabinets through gasketed connectors on the bottom side of the cabinets.
- "Hard Hat" antennas on vehicles are easily damaged and are less efficient than whip antennas which are also less expensive to replace.
- Interface units for the Modat digital alarm and status encoders were designed and constructed in order that Modat units on trucks can automatically send bed-up, bed-down, high temperature and low oil pressure signals along with the identity of the vehicle. The bed-up signal denotes that a load of rock has been dumped into a crusher and the Modat basic logic unit and printer can tally the number of loads dumped by each vehicle.
- A bell system which sends customary Morse code tone signals over the slope car's radio has been added. This provides instantaneous nonverbal communication which is familiar to mine personnel.

Following is a summary of the equipment and features of the radio system:

Three UHF two-frequency simplex channels in the Special Industrial Radio Service are used as follows:

| <u>Channel</u> | <u>Frequency</u>    | <u>Assigned Use</u>                          |
|----------------|---------------------|--|
| 1. (1)         | 451.950/456.950 mHz | Production, mine vehicles and supervisors    |
| (2)            | 451.950/451.950 mHz | Production talk-around simplex               |
| 2. (3)         | 452.175/457.175 mHz | Maintenance and general utility and standby  |
| (4)            | 452.175/452.175 mHz | Maintenance talk-around simplex              |
| 3. (5)         | 452.025/457/025 mHz | Slope car and loading dock to hoist operator |

The numbers in parenthesis indicate channel selector switch positions on mobile and portable radios.

Seven 12-watt UHF Motorola Micor tone controlled base/mobile repeater stations are used. All stations are provided with battery emergency power to sustain operation for at least four (4) hours as required by safety regulations.

One base/mobile repeater station operates on Channel 3 for communicating in the slope. Six (6) of the stations operate on Channels 1 and 2 and are equipped with Spectra-Tac encoders for use with the received signal comparator system. The best signal is selected and is relayed over the system. Each repeater station reverts to "in-cabinet" repeat in the absence of control tones.

The Channel 1 and 2 repeaters are located in pairs at three sites, which are:

- a. The radio room near the mine portal with one antenna covering the mine property above ground and a Yagi antenna directed into the slope for emergency communication with personnel in the slope.
- b. The radio and monitoring room near crusher no. 2 where the base/repeaters feed a distributed antenna system that covers the central and western side of the mine.
- c. Near crusher no. 3, where the base/repeaters feed distributed antennas which cover the eastern half of the mine.

Each pair of transmitters feeds a hybrid combiner and uses a duplexer

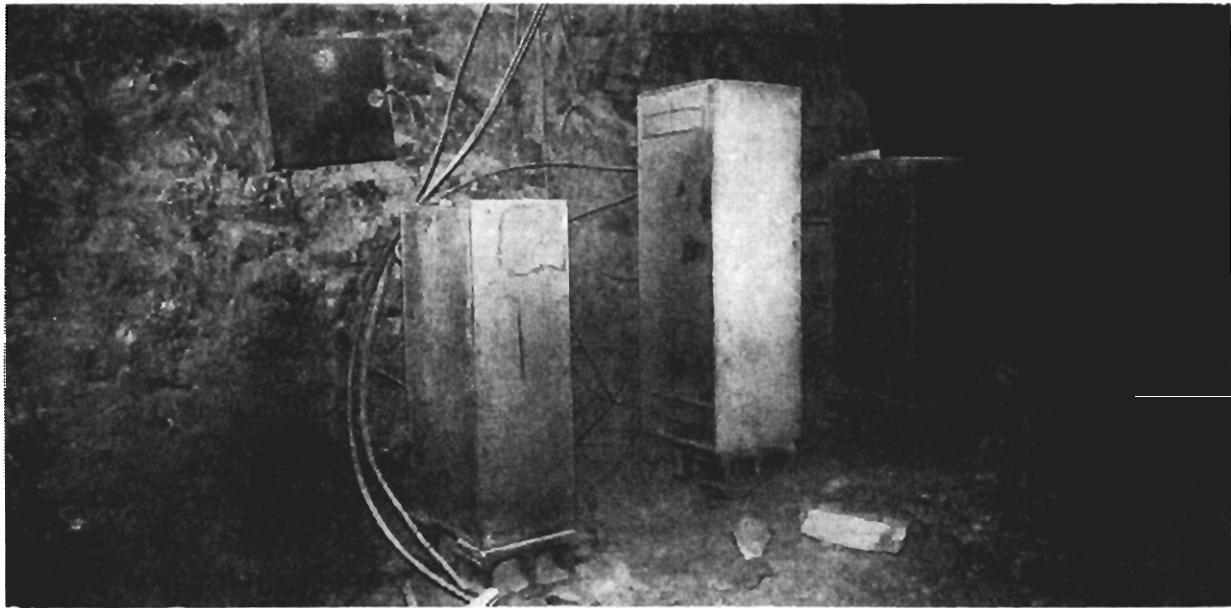

FIGURE 3.25. BASE STATIONS AND COMBINER NEAR CRUSHER NO. 3. THE CABINETS ARE WEATHERPROOF AND THE ENCLOSURE ON THE WALL CONTAINS STORAGE BATTERIES FOR UNINTERRUPTIBLE POWER.

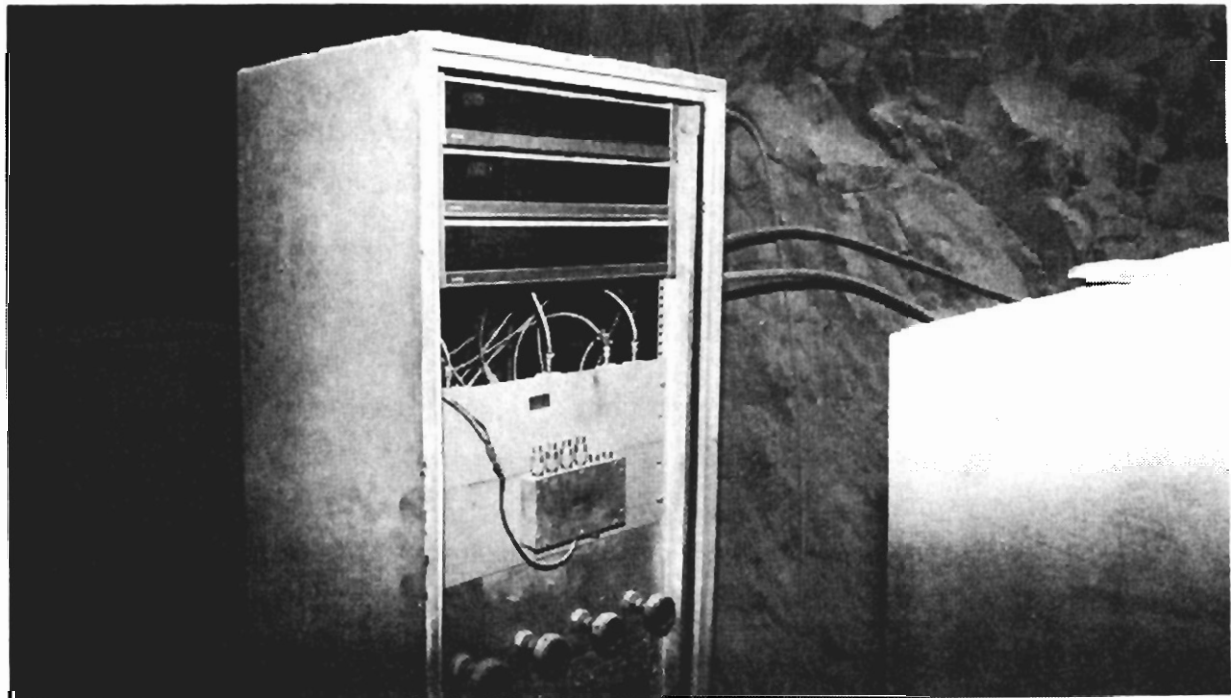

FIGURE 3.26. COMBINER CABINET WITH GASKETED DOOR REMOVED TO SHOW CATEL FM MODULATORS AND DEMODULATORS (TOP PANELS) AND THE TRANSMITTER COMBINER AND DUPLEXER.

and multicoupler to connect the receivers to the antenna system.

Two distributed antenna systems are used. The original system for the central and western sector of the mine (see Figure 2.9) used approximately one thousand feet of 7/8" low-loss coaxial cable to feed four antennas through power dividers. Since coverage was inadequate at the perimeter of the mine, approximately five thousand, six hundred feet of 1/2" low-loss coaxial cable and nine additional antennas and power dividers were installed. Four two-way UHF signal boosters will be added to this system, as shown on Figure 3.10.

The original antenna system for the eastern sector of the mine used approximately sixteen hundred feet of 7/8" low-loss coaxial cable to feed four antennas through power dividers. Approximately four thousand feet of 1/2" low-loss coaxial cable has been added to feed seven additional antennas through power dividers and two two-way UHF signal boosters will be added to this system.

Most of the antennas are 5dB gain mobile whips that are attached to one-foot square metal plates which are bolted to the mine roof at the center of intersecting crosscuts. (See Figure 3.20.) Several 9dB base station antennas, which are fifteen feet long, are located in high crosscuts which do not have vehicular traffic.

The Channel 3 base/mobile repeater is located in the radio room near the mine portal and it feeds a Yagi antenna that is directed down the slope.

All seven base/mobile repeaters can be controlled by tone signals from control consoles located in the engineering office in the administration building and in the hoist house. The control tones and two-way audio between the consoles and the repeaters are transmitted on 6.2 to 175 MHz FM carriers over a coaxial "back bone" cable system which extends from the radio room down the slope and on to the base station sites in the mine.

Three control stations also control the base/mobile repeaters. These stations are all consolettes with 25-watt output power, four-frequency operation on all three base/mobile repeater frequencies, plus one simplex channel, and they are equipped with Channel Scan receivers.

- The warehouse control station is used for communicating with the parts and powder trucks and the hoist house in order to coordinate transportation of material to the mine. This station uses an omnidirectional antenna on the warehouse roof.
- The control station at the loading dock near the base of the slope is used mainly for communicating with the hoist operator, persons on the slope car, and the mine foreman's office. It uses a Yagi antenna that is directed up the slope.

Radio communications at the base of the slope are necessary to facilitate moving the slope car, obtaining parts, and contacting the mine foreman's office. Ambient noise levels are extremely high; the control station microphone was too sensitive; it picked up the conveyor belt noise almost to the exclusion of the voice. Three (3) watts of received audio could hardly be heard over other noise even when one was standing next to the control station.

To overcome the local noise problems, two changes were required. A telephone-type handset was used to replace the desk-type microphone, and the received audio power was increased to 15 watts by adding a power amplifier.

- The mine foreman's office control station can communicate through both pairs of base/mobile repeaters which are located near crushers no. 2 and 3. It is used mainly for calling or responding to calls from mechanics, electricians, mine supervisory personnel, vehicle and equipment operators. Due to its location, this station cannot access Channel 3 used in the slope although the radio has Channel 3 crystals.

It was necessary to replace the base station microphone with a mobile palm-type speaker microphone to overcome a serious hum problem. The fluorescent lights were inducing a severe noise into the desk microphone and normal grounding was not feasible to correct the problem.

A Modat basic logic decoding unit is connected to the Consolette for displaying IDs and emergency signals. However, the consolette receiver automatically scans both Channel 1 and Channel 2 sequentially, and if an emergency alarm is transmitted on the channel that was not then being scanned, it might be missed. Several alternatives are being considered, such as adding another receiver and eliminating the scanning feature. Since the foreman's office is locked while it is not manned, an audible emergency alarm with a reset button is needed in the working area of the shop.

Fifteen two-watt transceivers and fourteen eleven-watt mobile radios are used. All radios send an identification code (ID) each time that the press-to-talk or emergency call switch is used, and they are equipped with tone coded squelch.

A printer associated with the Modat decoder in the engineering office prints the ID and time of day each time that a call is received. Emergency alarms also are printed and are audibly annunciated in the office building, hoist house and foreman's office, and a future alarm annunciator is proposed in the shop area.

The encoders that are used on four mine trucks which haul rock to the crushers have been modified to automatically send four status signals: truck bed up (dumping), truck bed down, hot engine and high oil pressure. This information is displayed by number codes along with the truck's identification number on the Modat display units in the engineering office above ground and the mine foreman's office underground. Also, a record of the number of loads dumped into the crushers is automatically printed in the engineering office.

Following is a list of the vehicles that are equipped with Motorola Model MCR-100 mobile radios:

| <u>Quantity</u> | <u>Type of Vehicle</u> | <u>Features</u>   |
|-----------------|------------------------|---|
| 1               | Slope car              | PTT ID, emergency alarm and tone signal   |
| 4               | Mine trucks            | PTT ID, emergency alarm, bed-up and bed-down status, engine temperature and oil pressure alarms |
| 1               | Scaler                 | PTT ID and emergency alarm  |
| 4               | Loaders                | PTT ID and emergency alarm  |
| 1               | Hydraulic drill        | PTT ID and emergency alarm  |
| 1               | Drill                  | PTT ID and emergency alarm  |
| 1               | Delivery truck         | PTT ID and emergency alarm  |
| 1               | Spare                  | PTT ID and emergency alarm  |

The fifteen Motorola type MX-350 portable transceivers equipped with PTT ID and emergency alarms are assigned to:

- 1      Underground Operations Superintendent
- 1      Production Foreman
- 1      Drill Foreman
- 1      Maintenance Foreman
- 1      Safety Director
- 1      Shop
- 1      Halfway station in slope
- 1      Conveyor
- 1      Crusher
- 2      Drills
- 2      Pinners
- 1      Powder Truck
- 1      Blaster

Remote speaker/microphones and Muffcoms (noise reduction ear protectors with bone conduction microphone) are provided for each radio. The choice of



speaker/microphone or Muffcom is up to the individual user; the Muffcoms are used in noisy areas.

The radios were initially equipped with Heliflex antennas. Coverage using these short antennas was not adequate, so they were replaced with flexible one-quarter wave (6") whips which increased their range.

A combination of single and multiple-unit battery chargers are provided to keep all radio batteries fully charged. All batteries can be rapidly charged in one hour. A full complement of fifteen (15) spare one-hour rapid charge batteries is provided for emergency backup.

The two Motorola type T-1617 control consoles, located in the engineering office and the hoist house have the following basic features:

- a. Tone control of base/repeater stations
- b. Tone busy light to indicate when any channel is being used at the other console
- c. Call light for indicating incoming call
- d. Mute switch for attenuating unselected channel
- e. Individual line level control for each channel
- f. Digital 12/24-hour clock
- g. "Private line" tone-coded squelch
- h. Intercom
- i. Alert tone

The console in the engineering office is a standard model, equipped with a desk microphone.

The console in the hoist house is mounted on a shelf in front of the hoist operator. A boom microphone and a foot-operated PTT switch are used because of the high noise level and the need for hands-free operation. (See Figure 3.16.)

Also due to the high noise level in the hoist house, the selected and

unselected loudspeakers had to be relocated immediately behind and on either side of the hoist operator's head. Two standard mobile radio speakers were installed and have been very satisfactory.

Horn (or belling) signals sent from the slope car must be answered by the hoist operator before moving the car. The horn signalling button that is normally used by the hoist operator also is connected to send the alert tone signal from the console by radio on Channel 3. Thus, the customary horn signals which are heard in the hoist house, top of the slope, midway and at the base of the slope also are heard on the moving slope car as long-short alert tones emanating from the radio loudspeaker.

A unique feature of the radio and CCTV systems is the use of CATV technology and equipment for transmitting control, audio, digital and television signals over a coaxial cable network. Figure 3.27 shows the "back bone" coaxial cable layout on a mine map.

The completed system will use a pair of coaxial cables to provide redundancy; one cable which is completely installed and equipped extends from the radio equipment room in the office building down the slope and branches to serve the radio CCTV and monitoring equipment in the mine. The second cable has been installed in a bore hole near the lime plant, and it extends in the mine using different routes to the same equipment that the first cable serves.

The second cable will be extended above ground via pole attachments from the lime plant to the radio equipment room. Both cables will be simultaneously fed, and in the event of the failure of one cable, the other cable can be used.

Twenty-seven CATEL FM modulators and demodulators are used to multiplex the control, audio, digital and video signals on carrier frequencies ranging from 6.2 to 175.1 MHz, as is shown on Figures 3.28 through 3.31 four additional modulators and demodulators have been proposed for a future digital environmental monitoring system.

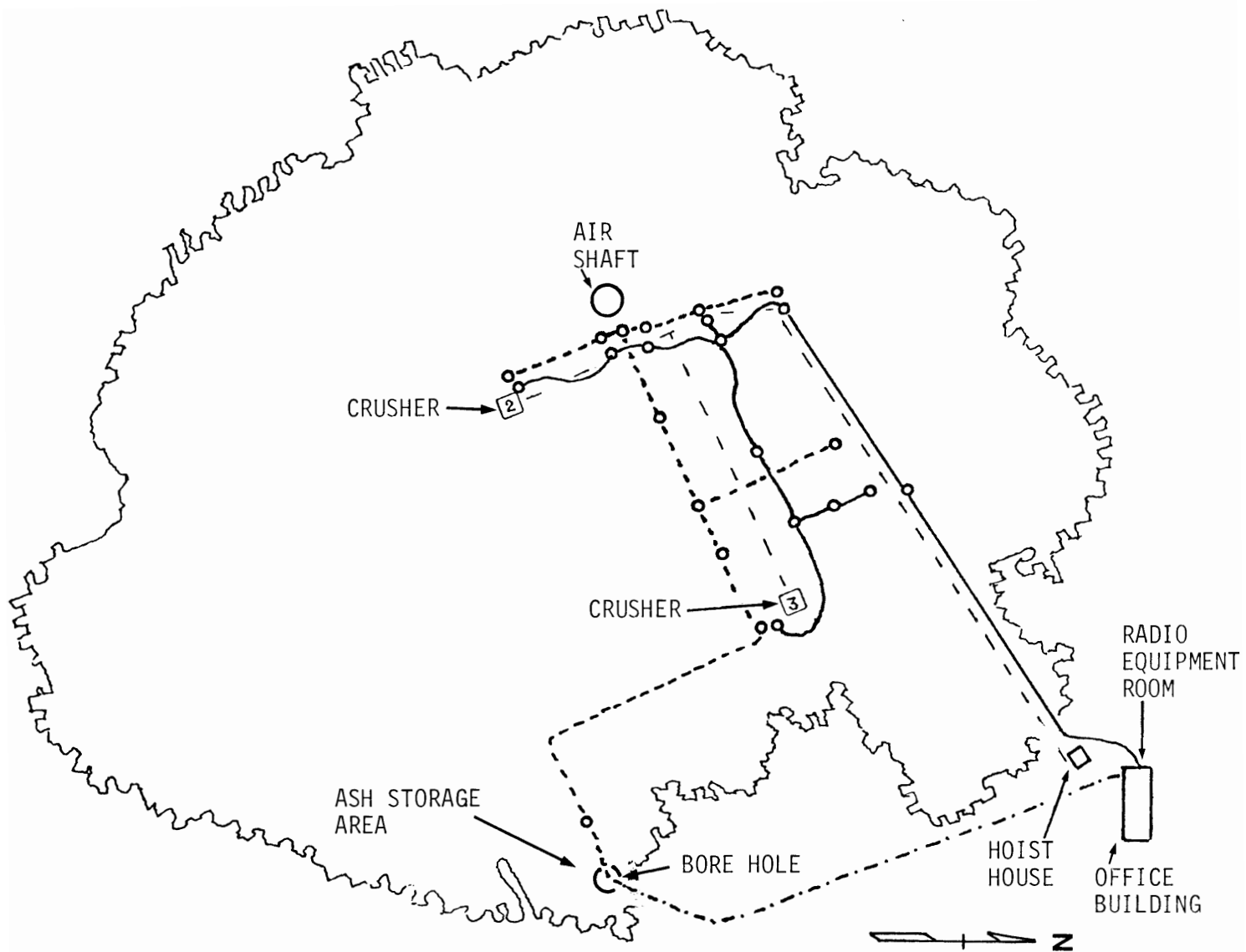

LEGEND

- BACK BONE CABLE NO. 1 INSTALLED THROUGH SLOPE.
- -○- - BACK BONE CABLE NO. 2 INSTALLED IN MINE.
- · - · - BACK BONE CABLE ABOVE GROUND TO RADIO ROOM.
- The circles in the cable represent multicouplers for connecting multiplexing FM modulators or demodulators
- - - - - ROCK CONVEYOR BELT.

FIGURE 3.27 FINAL DESIGN OF BACK BONE CABLE SYSTEM

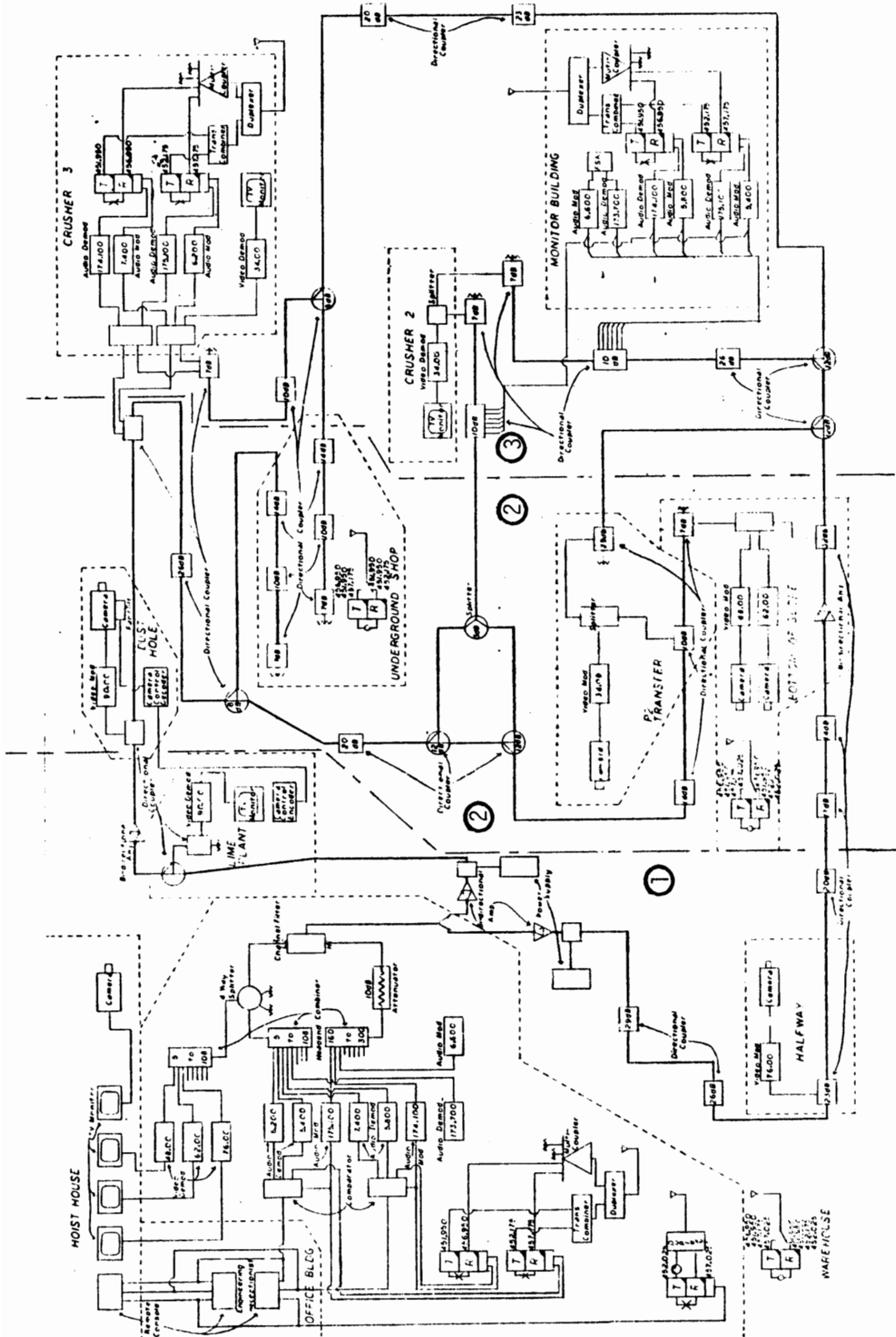
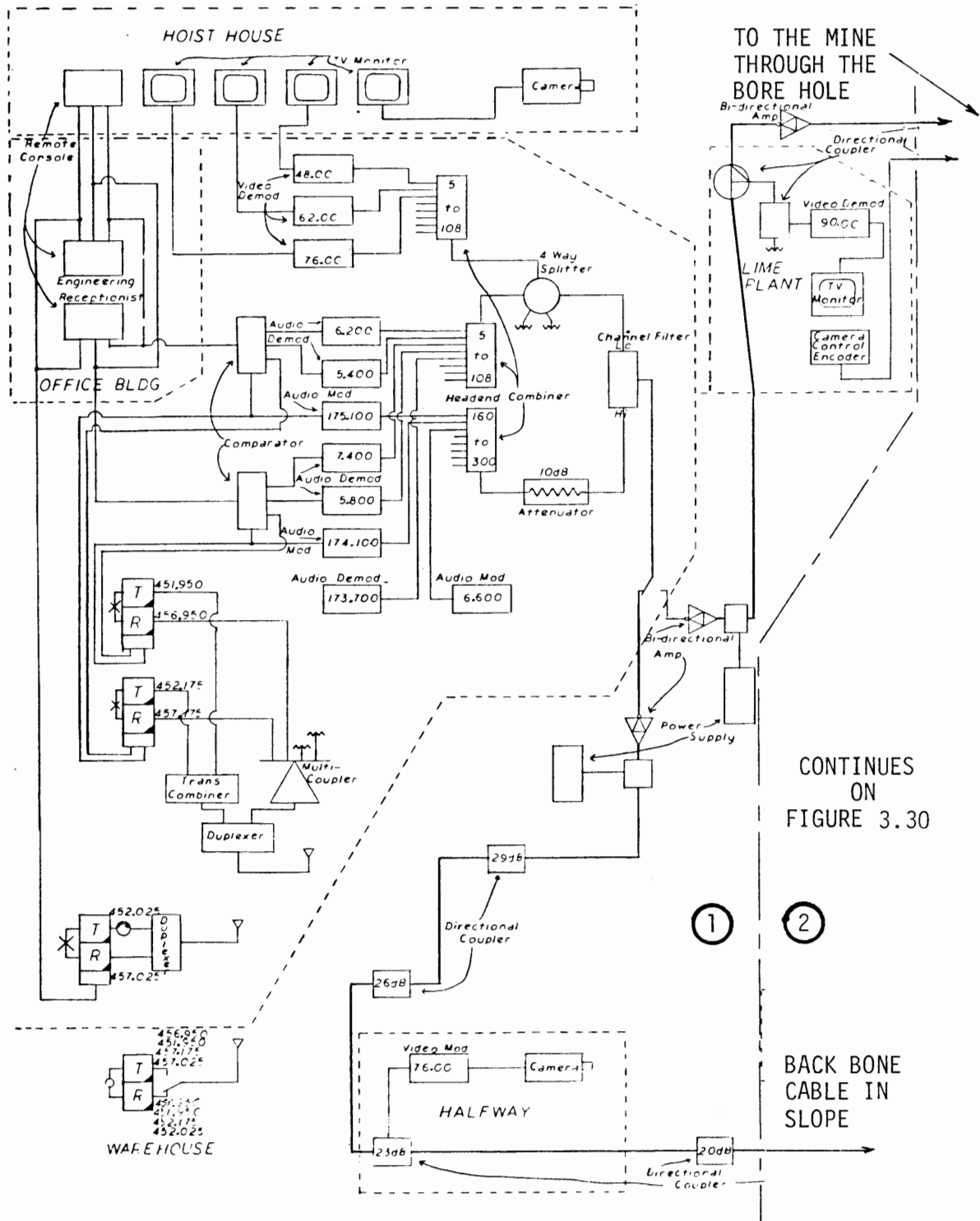

FIGURE 3.28 COMPOSITE BLOCK DIAGRAM OF RADIO AND CCTV SYSTEM IN FEBRUARY 1981. ENLARGED SECTIONS OF THIS DRAWING ① ② ③ ARE SHOWN ON FIGURES 3.29, 3.30 AND 3.31.



CONTINUES  
ON  
FIGURE 3.30

BACK BONE  
CABLE IN  
SLOPE

FIGURE 3.29 BLOCK DIAGRAM OF RADIO AND CCTV SYSTEMS THAT ARE ABOVE GROUND. THIS DRAWING IS AN ENLARGEMENT OF THE LEFT HAND SECTION 1 ON FIGURE 3.28.

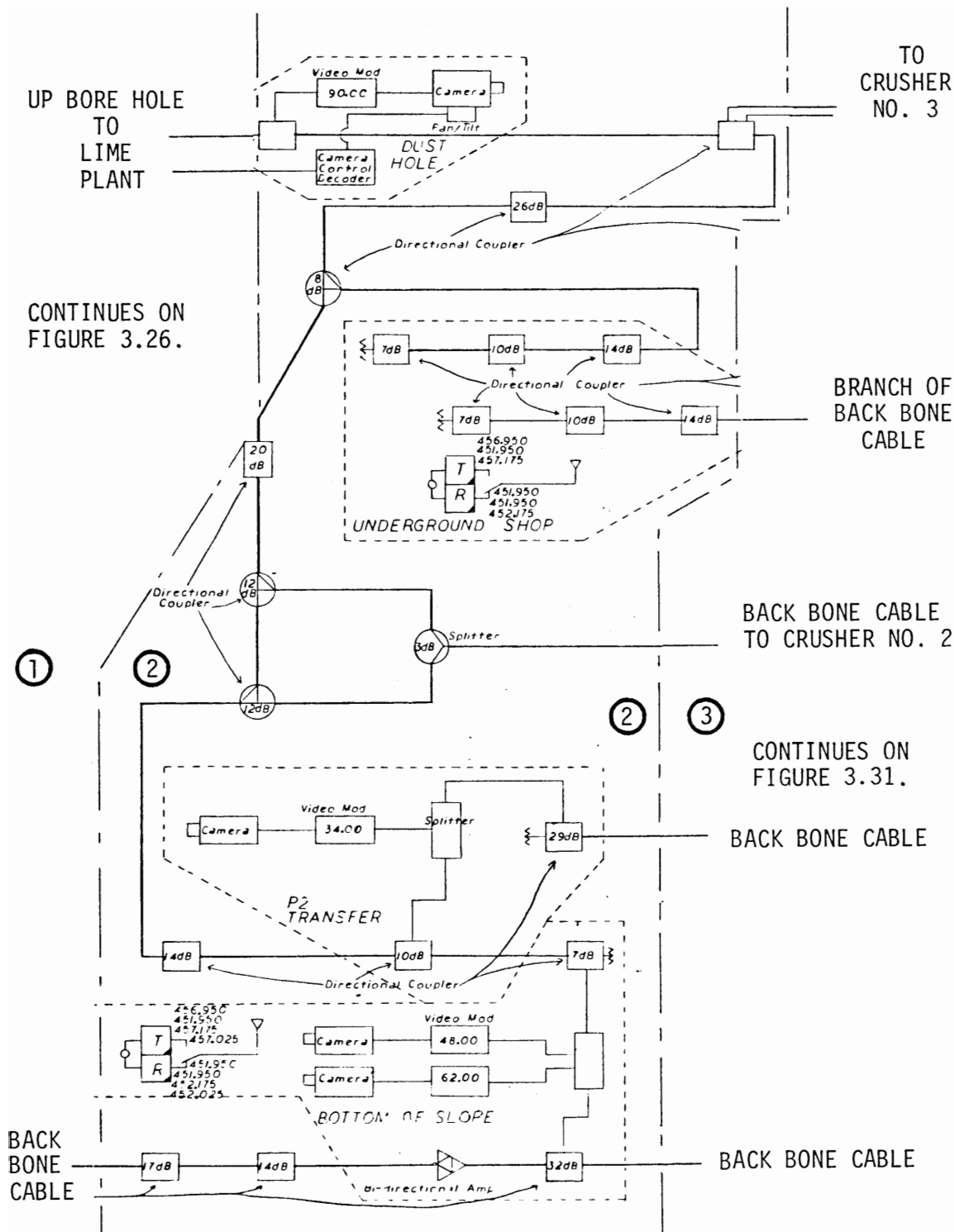

FIGURE 3.30. BLOCK DIAGRAM OF A PORTION OF RADIO AND CCTV SYSTEMS IN THE MINE. THIS IS AN ENLARGEMENT OF SECTION ② SHOWN ON FIGURE 3.28.

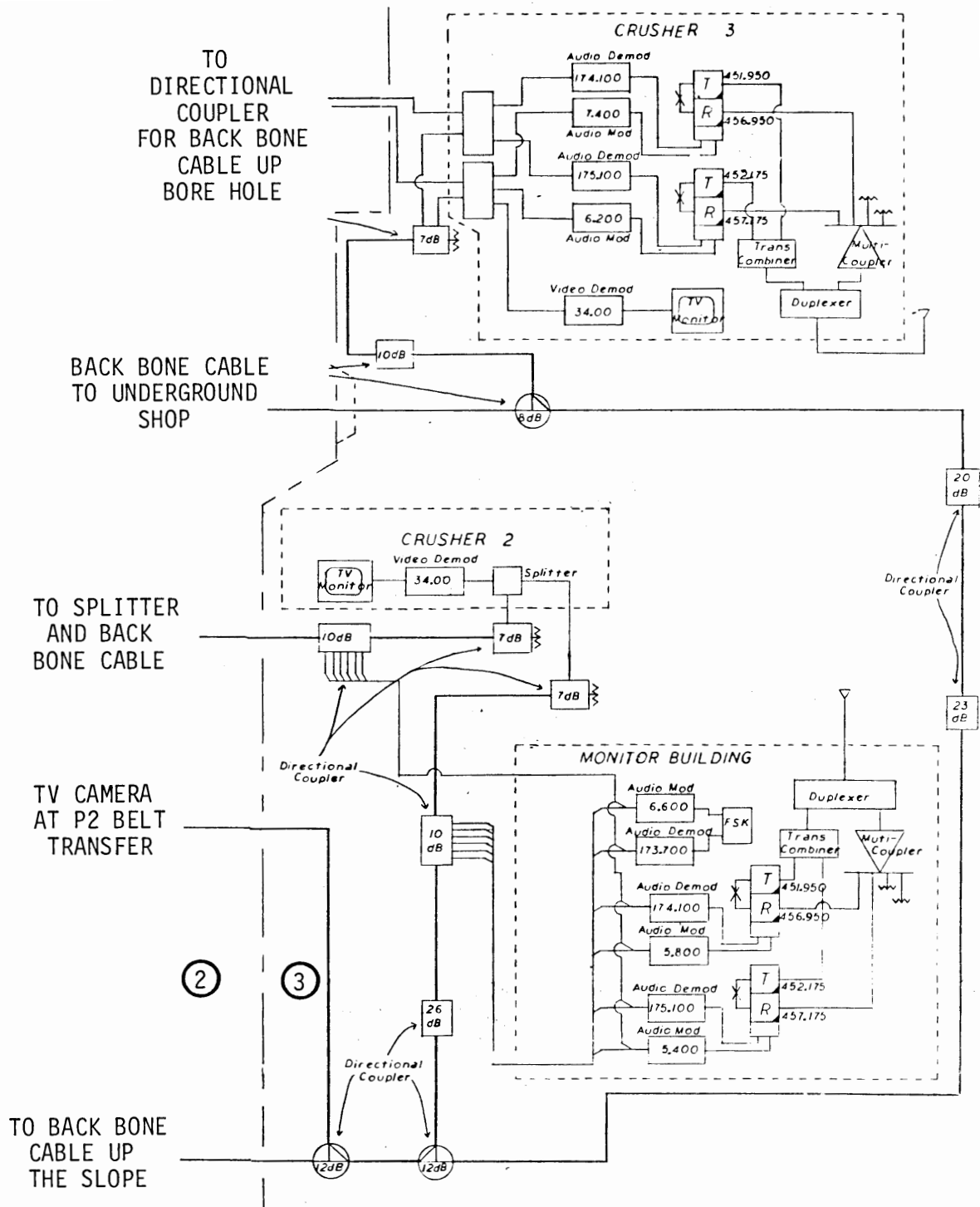

FIGURE 3.31. BLOCK DIAGRAM OF A PORTION OF RADIO AND CCTV SYSTEMS IN THE MINE. THIS IS AN ENLARGEMENT OF SECTION ③ OF FIGURE 3.28.

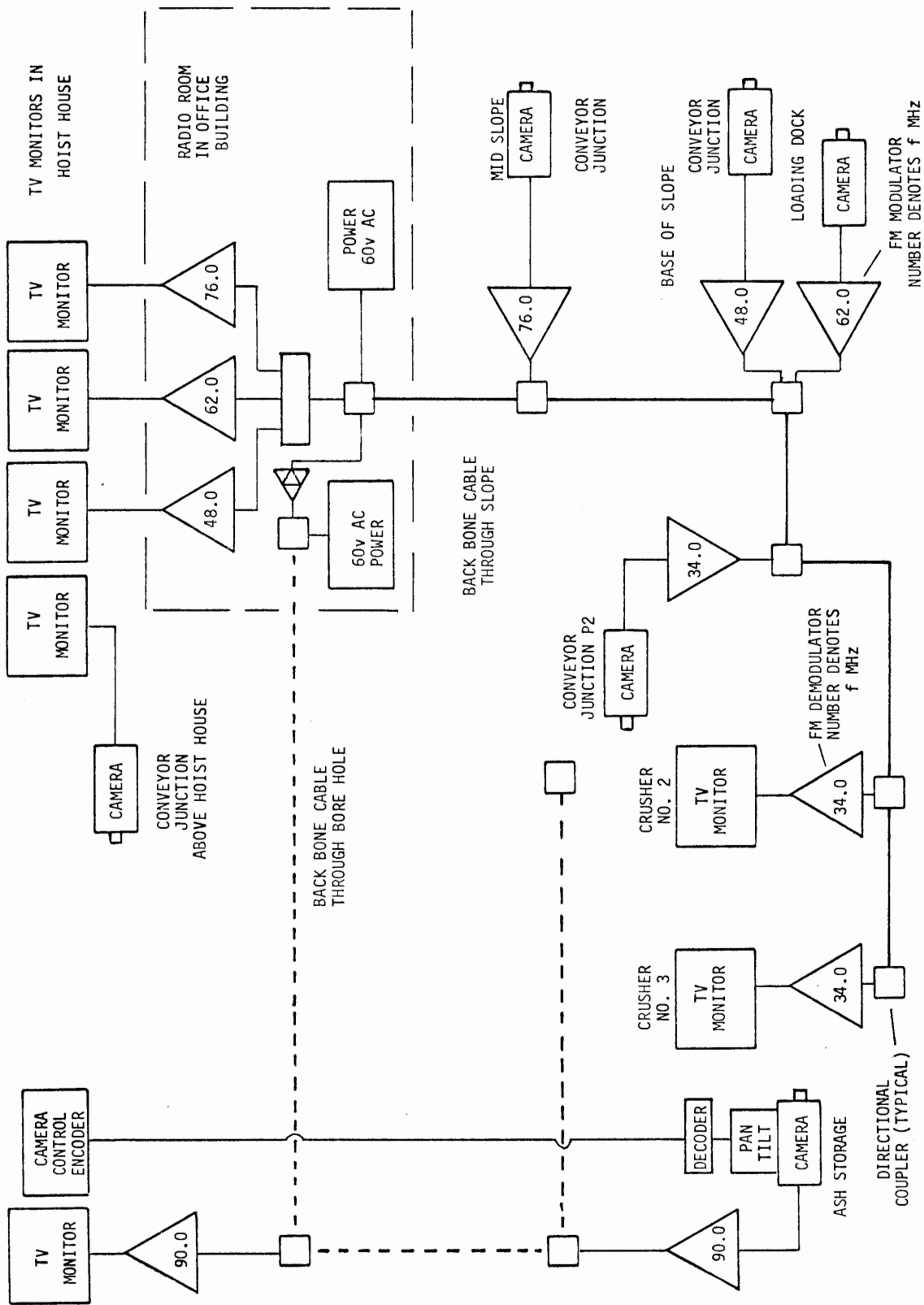

FIGURE 3.32 SIMPLIFIED BLOCK DIAGRAM OF CCTV SYSTEM



### 3.23 As-Built CCTV System Description

Six Motorola V-10003C CCTV cameras, seven Motorola 51252 nine-inch TV monitors and accessory equipment are used for observing critical areas at the mine. Each of the cameras feeds its composite video signal to a CATEL modulator and a CATEL demodulator feeds each TV monitor as shown by Figures 3.28 through 3.32. Following is a summary of the equipment and how it is used:

| <u>Location Viewed</u>   | <u>Back Bone Cable<br/>Modem Frequency,<br/>MHz.</u> | <u>TV Monitor Location</u>   |
|--|--|--|
| Conveyor belt transfer above hoist house   | Direct video on coaxial cable                        | Hoist house  |
| Conveyor belt transfer midway in slope   | 76.0   | Hoist house  |
| Conveyor belt transfer at base of slope  | 48.0   | Hoist house  |
| Loading dock at base of slope  | 62.0   | Hoist house  |
| Conveyor belt transfer No. 2 in mine   | 34.0<br>34.0   | Crusher No. 2<br>Crusher No. 3   |
| Dust storage area camera (is also equipped with a pan tilt head and camera control decoder). | 90.0   | Lime plant control console. A camera control encoder for the pan tilt head also is provided. |

The CCTV surveillance system has greatly enhanced safety and improved the efficiency of loading and unloading the slope car at the base of the slope. The hoist operator can see that all personnel are in the clear and materials are properly loaded before the winch is started to pull the slope car to the surface.

The down time of the belt conveyor system has been reduced because the crusher operators and hoist operator can see rock jams building up at the critical transfer points. Without television surveillance, rock jams have stopped the belts, and friction at drive pulleys has caused belts to burn or to be otherwise damaged. Drive motors also have failed due to excessive loads.

Television surveillance of the dust storage area is also expected to improve working conditions in the mine by preventing the air from being contaminated with dust if the pipeline is ruptured.

### 3.24. Research on the State of the Art of Underground Radio Communications

During the course of this project, the Radio Engineer studied the state of the art in underground radio communications in Europe.

Research was conducted on systems in England and Europe. Reviews were made of similar studies, symposia and technical conferences to gain insight on design and technique.

Comsul Ltd. included in the references titles of papers which were collected and the names of persons who are actively engaged in developing underground communication systems. <sup>17</sup>

The systems which appear to be most promising for mine applications are:

- . The distributed antennas and two way signal boosters that were developed during this project at the Black River Mine.
- . The TX/RX two way signal booster and leaky coaxial cable antenna system that is being installed in the Sesser room and pillar coal mine in Illinois by Motorola Communications and Electronics.
- . The use of CATV amplifiers and multiplexing equipment in the manner of a system that will be installed in the Washington Metropolitan Area Transit Authority (WMATA) subway.
- . The Ariadne daisy chain system with intermediate frequency return that was developed by Dr. D.J.R. Martin of the National Coal Board in England is appropriate for mines where only low energy intrinsically safe radio systems can be used.

(17) Isberg, R.A., P.E., "A Study of the Technology of Underground Radio Communication in Europe", 1980 Rapid Transit Conference, American Public Transit Assn., June 1980.

#### 4.0 DEMONSTRATION OF SAFE OPERATION OF 450 MHz MOBILE AND PORTABLE RADIO TRANSMITTERS ADJACENT TO A DRILLED ROCK FACE LOADED WITH BLASTING CAPS.

##### 4.1 Background and Purpose of Demonstration

While the radio propagation tests and installations were being made in the mine several of the mine's employees requested assurance that operation of the mobile and portable radio transmitters in the vicinity of electrical blasting caps would be safe. Accordingly, the Black River Mine Company requested the Bureau of Mines, Pittsburgh Research Center (PRC) to demonstrate to the employees in the mine that a typical mobile radio transmitter of the type to be used in the mine would not cause blasting caps loaded in a rock face to detonate. A successful demonstration was made by representatives of the PRC and Motorola Communications and Electronics, Inc., in December 1978.

However, several of the mine's employees were not satisfied with the results of the tests because only one transmitter was used and several radio equipped mine vehicles plus several hand carried portables might be operated simultaneously near a loaded face thereby radiating more energy which might be received by the wires leading to the caps and detonate them. The miners' union representatives requested another demonstration using three radio equipped mine vehicles and several portable radios operating simultaneously near a drilled rock face loaded with electrical blasting caps.

The mine forwarded this request to the PRC and the Mine Safety and Health Administration (MSHA) at Lexington, KY. Comsul Ltd. was then asked by the PRC to plan and coordinate another demonstration of safe radio operation near a wired face on August 22, 1979.

##### 4.2 Procedures for Conducting the Demonstration

A rock face in crosscut 97 was drilled in the normal pattern of holes and each hole was loaded with an electrical blasting cap, as shown on Figure 4.1.

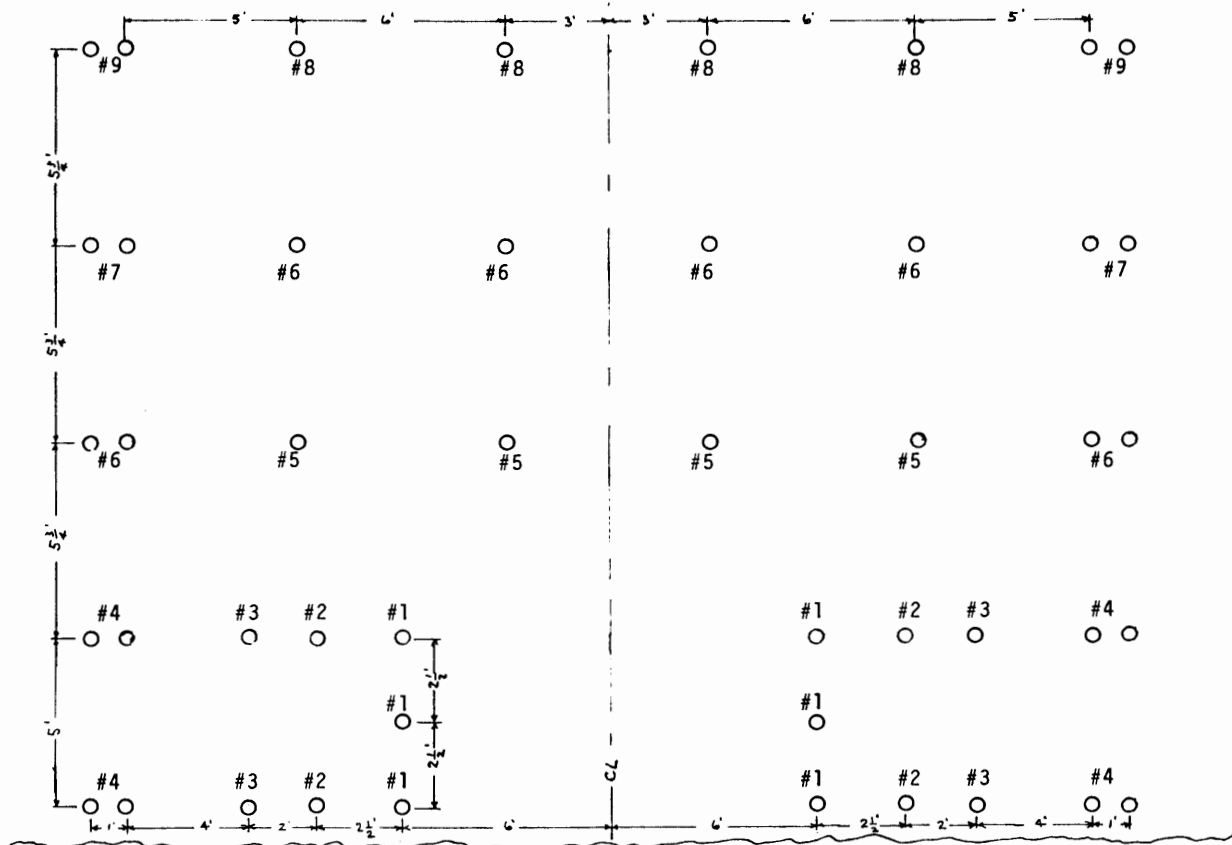

FIGURE 4.1 PATTERN OF HOLES DRILLED IN LIMESTONE FACE FOR BLASTING CAPS USED FOR DEMONSTRATING SAFE RADIO OPERATION OF MOBILE AND PORTABLE UHF RADIOS IN THE VICINITY OF ELECTRIC BLASTING CAPS AND ASSOCIATED WIRING.

The hole pattern shown above is normally used in the Black River Mine. Each of the forty-eight holes was loaded with Atlas Time Master blasting caps having "time delay" as indicated from 0-9. The caps were connected in series and the blasting line was run on the ground to the observation point where it was shunted while persons were near the face.

A pair of detonator leads were connected to the network of blasting caps and was extended to the observation position approximately 120' from the loaded face. Removable shunts were connected across the detonator leads at the face and also at the observation point. These shunts were required by the MSHA representatives to insure the safety of personnel while they were near the loaded face. The shunts at the face were disconnected after the shunt was connected at the observation point. Three operating portable two watt transmitters were then carried by a technician to the face and placed on the back seat of the pick up truck which was parked nearby. After the technician returned, the shunt at the observation point was disconnected leaving the detonator line open circuited except for the resistance in the network of blasting caps. See Figure 4.2.

The relative positions of the three vehicles, the wired face and the observation point are shown on Figure 4.2. The transmitter keying leads of the mobile radios on the three vehicles were extended by a multiconductor cable approximately 110' to the observation point where they were connected to three single pole single throw switches.

Bird Thru-Line Watt meters were connected in series with the antenna lead from each of the mobile transmitters and placed where they could be read from the ground level.

#### 4.3 Test Results

Test 1 - Three mobile transmitters and three portable transmitters were simultaneously operated on 451.95 MHz for approximately one minute.

| <u>Vehicle</u> | <u>Transmitter Output to Antenna</u> |
|----------------|--------------------------------------|
| Loader 224     | 14 Watts                             |
| Truck #8       | 11 Watts                             |
| Pick up Trunk  | 11 Watts                             |
| Portable 1     | 2.2 Watts                            |
| Portable 2     | 2.1 Watts                            |
| Portable 3     | 2.1 Watts                            |

LIMESTONE ROCK FACE DRILLED AND LOADED WITH 48 ATLAS TIME MASTER BLASTING CAPS.

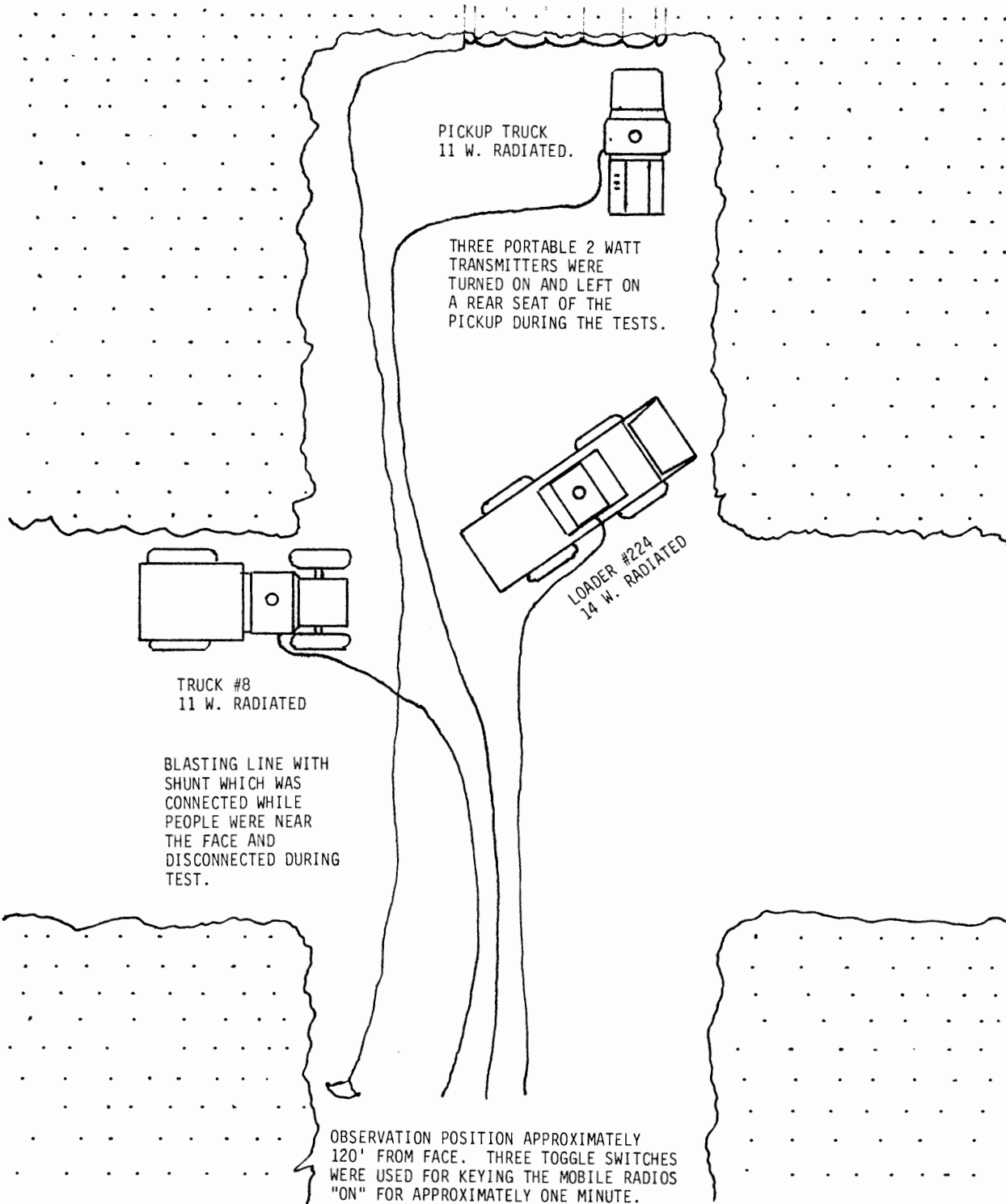

FIGURE 4.2 APPROXIMATE LOCATIONS OF VEHICLES EQUIPPED WITH MOBILE UHF RADIOS WHICH WERE PARKED ADJACENT TO THE DRILLED FACE LOADED WITH 48 BLASTING CAPS IN THE BLACK RIVER MINE, AUGUST 22, 1979.

Test No. 1 (Continued)

- A. The mobile radios transmitted continuously for approximately one minute until they were turned off by time-out timers which created three tone signals that were heard by all present at the observation point.
- B. The portable transmitters were operated for approximately two minutes because they were turned on and off manually and were left on the seat of the pick-up which was parked near the loaded face. See Figure 4.3.
- C. The caps were not detonated.

Test 2 - This test was identical to Test 1 except the transmitter frequency was changed to 457.175 MHz. The output power was the same as tabulated for Test 1 and the caps were not detonated.

Test 3 - Identical to Test 1 except the transmitter frequency was changed to 452.175 MHz. The output power was essentially the same as for Test 1 and the caps were not detonated.

Test 4 - Only three portable transmitters were operated on 457.025 MHz. The output power was approximately 1.9 watts for each portable and the caps were not detonated.

Test 5 - Test of the blasting caps with a detonator.

A DuPont capacitor discharge detonator was connected to the firing line and all caps were detonated proving that the caps were all live and that the electrical wiring of the caps' leads was correct and satisfactory.



FIGURE 4.3. THE RADIO EQUIPPED VEHICLES WERE PARKED ADJACENT TO THE DRILLED ROCK FACE THAT HAD BEEN LOADED WITH ELECTRICAL BLASTING CAPS.



FIGURE 4.4. THE OBSERVERS OF THE TESTS WERE APPROXIMATELY 120' FROM THE FACE THAT WAS LOADED WITH BLASTING CAPS. THE LEADS FOR KEYING THE THREE MOBILE TRANSMITTERS AND FOR SHUNTING THE FIRING LINE CAN BE SEEN ON THE FLOOR.



4.4 Computations of the Amount of Radio Energy that is Available Near Mobile and Portable Radio Antennas.

The radio energy reaching a wired face from nearby portable and mobile transmitters can be computed as follows:

a. Wavelength of radio signal =  $\frac{984}{f \text{ MHz}} = \frac{984}{451} = 2.18'$

b. At one wavelength (2' 2") between two isotropic antennas the available power would be attenuated 22 dB compared to the radiated power. Since the portable and mobile antennas have approximately 2 dB gain compared to an isotropic antenna, the available power at 2' 2" will be approximately 20 dB (1/100) less than the radiated power.

If a 2 watt portable transmitter is operated 2' - 2" from a blasting cap, the radio energy reaching the cap would be 2/100 of one watt.

c. Each time the distance from the antenna is doubled the received power will be divided by four which is an additional 6 dB reduction. The power reduction versus distance for a mobile transmitting antenna radiating 15 watts on 450 MHz is computed as follows:

| <u>Distance From Antenna</u> |             | <u>Power Available, Watts</u> |
|------------------------------|-------------|-------------------------------|
| <u>λ</u>                     | <u>Feet</u> |                               |
| 1                            | 2.18'       | 0.15                          |
| 2                            | 4.36'       | 0.0375                        |
| 4                            | 8.72'       | 0.0094                        |
| 8                            | 17.44'      | 0.0023                        |
| 16                           | 34.88'      | 0.0006                        |
| 32                           | 69.76'      | 0.0001                        |

- d. Following is an estimate of the amount of radio power reaching the loaded face from the three mobile and three portable transmitters during the tests on August 22, 1979.

| <u>Vehicle</u> | <u>Radiated Power Watts</u> | <u>Approximate Distance From Face, Feet</u> | <u>Approximate Power Received At Face, Watts</u> |
|----------------|-----------------------------|---|--|
| Loader #224    | 14                          | 18'   | .0023  |
| Truck #8       | 11                          | 35'   | .0004  |
| Pick up Truck  | 11                          | 9'  | .0004  |
| Portable 1     | 2.2                         | 9'  | .0014  |
| Portable 2     | 2.1                         | 9'  | .0014  |
| Portable 3     | 2.1                         | 9'  | .0014  |
|                |                             |   | <u>0.0072</u>                                    |

#### 4.5 Conclusions

1. This demonstration proved that three eleven watt mobile transmitters and three 2 watt portable transmitters can be safely operated simultaneously in the 451-457 MHz spectrum when they are all located within ten to forty feet from a rock face drilled in a hole pattern that was 22- $\frac{1}{4}$ ' and 31' long and loaded with forty-eight Atlas Time Master electrical blasting caps which were connected as shown on Figure 4.1.
2. The total amount of radio energy that reached the wired face during the tests with three mobile and three portable transmitters operating nearby was seven milliwatts.
3. The miners in the Black River Mine were satisfied with the results of the demonstration and have not objected to using the radios near blasting areas.

4. The results of these tests also are described in a report that is available from the Mine Electrical Systems Branch of MSHA.<sup>18</sup>  
The conclusions from this report are quoted below:

"It is the opinion of the investigators that no hazard exists from operating this communication system in the Black River Mine, if the IME guidelines for radio transmissions around blasting caps are followed.

"In compliance with IME Publication #20, The Mine Electrical Systems Branch (MESB) also recommends that the mine establish a procedure to insure that the radios will not be used any closer than 20 feet from a blasting circuit".<sup>19</sup>

- (18) Report No. M092479, "RF Hazards to Electrical Blasting Caps at Black River Mine", MSHA Mine Electrical Systems Branch, 4800 Forbes Avenue, Pittsburgh, PA 15213.
- (19) ME Publication No. 20, Safety Guide for the Prevention of Radio Frequency Radiation Hazards in the use of Blasting Caps, Institute of Makers of Explosives, 420 Lexington Ave., New York, N.Y. 10017.

FIGURE 5.1

# OPERATING PROCEDURES FOR PORTABLE RADIOS IN THE BLACK RIVER MINE, BUTLER, KENTUCKY

WEAK SIGNALS WILL BE IMPROVED IF RADIO IS HELD SO THAT ANTENNA IS NOT CLOSE TO YOUR BODY OR METAL SURFACES

**BATTERY STATUS AND TRANSMIT INDICATOR**

GLOWS WHEN PRESS-TO-TALK SWITCH IS DEPRESSED. THE LIGHT WILL BE DIM OR WILL NOT GLOW WHEN THE BATTERY HAS LESS THAN 5% CHARGE REMAINING. REPLACE THE BATTERY WITH A FULLY CHARGED ONE IF THE LIGHT IS DIM.

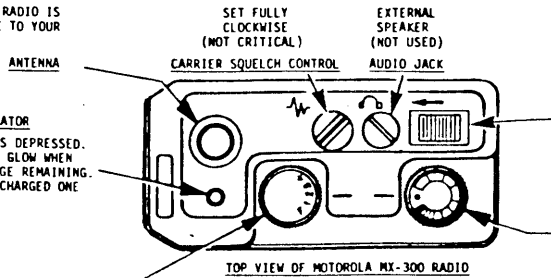

TOP VIEW OF MOTOROLA MX-300 RADIO

**EMERGENCY ALARM SWITCH**

SLIDE THE SWITCH TOWARD THE ANTENNA TO SEND AN EMERGENCY CALL. THE RADIO'S IDENTIFICATION NUMBER (ID) AND ALARM SIGNAL WILL BE REPEATEDLY TRANSMITTED UNTIL THE SWITCH IS RELEASED. YOU WILL NOT HEAR ANYTHING, BUT THE RADIO THEN SENDS TWO ID/EMERGENCY MESSAGES EVERY FIVE SECONDS FOR THIRTY SECONDS. TO STOP THE SEQUENCE EARLY, TURN THE VOLUME CONTROL ON/OFF SWITCH TO THE OFF POSITION MOMENTARILY AND THEN ON AGAIN TO RESUME NORMAL OPERATION.

**ON/OFF SWITCH AND VOLUME CONTROL**

TURN CLOCKWISE APPROXIMATELY HALF WAY AND ADJUST SO VOICES ARE EASY TO UNDERSTAND. TURN OFF BY ROTATING COUNTER CLOCKWISE TO CLICK STOP.

**RADIO CHANNEL SELECTOR SWITCH ASSIGNMENTS**

1. MAIN PRODUCTION CHANNEL. MINERS AND MINE VEHICLES NORMALLY WILL USE CHANNEL 1 WHICH USES REPEATERS TO SERVE MOST OF THE HAULAGE AND TRAVEL ROUTES AND WORK AREAS. EMERGENCY CALLS WILL BE RECEIVED IN THE SHOP OFFICE AND IN THE ENGINEERING OFFICE ABOVE GROUND.
2. LOCAL PRODUCTION CHANNEL IS USED BY MINERS WHO ARE NEAR EACH OTHER AND WHEN THEIR COMMUNICATIONS DOES NOT NEED TO BE HEARD BY OTHERS IN THE MINE OR ABOVE GROUND. THIS CHANNEL DOES NOT USE THE REPEATERS SO BE SURE TO SWITCH BACK TO CHANNEL 1 WHEN YOUR CONVERSATION IS FINISHED IN ORDER THAT YOU CAN BE CALLED AND YOUR EMERGENCY CALLS WILL BE RECEIVED IN THE SHOP AND ENGINEERING OFFICE.

3. MAIN MAINTENANCE CHANNEL IS USED BY FOREMAN AND MECHANICS AND, LIKE CHANNEL 1, IT USES REPEATERS PROVIDING COMMUNICATION THROUGHOUT THE MINE AND EMERGENCY ALARMS ARE RECEIVED IN THE SHOP AND ENGINEERING OFFICES.
4. LOCAL MAINTENANCE CHANNEL IS USED BY FOREMAN AND MECHANICS WHO ARE NEAR EACH OTHER AND WHEN THEIR COMMUNICATIONS DOES NOT NEED TO BE HEARD BY OTHERS IN THE MINE OR ABOVE GROUND. THIS CHANNEL DOES NOT USE THE REPEATERS SO BE SURE TO SWITCH BACK TO CHANNEL 3 WHEN YOUR CONVERSATION IS FINISHED IN ORDER THAT YOU CAN BE CALLED AND YOUR EMERGENCY CALLS WILL BE RECEIVED IN THE SHOP AND ENGINEERING OFFICES.

**OPERATING PROCEDURES**

1. BEFORE TRANSMITTING, LISTEN TO THE CHANNEL TO BE SURE OTHERS ARE NOT USING IT.
2. THE PRESS-TO-TALK SWITCH AUTOMATICALLY SENDS A TONE SIGNAL THAT IDENTIFIES YOUR RADIO EACH TIME THAT IT IS DEPRESSED SO WAIT ABOUT TWO SECONDS (TIME REQUIRED TO COUNT TO YOURSELF "ONE HUNDRED ONE, ONE HUNDRED TWO" BEFORE SPEAKING).
3. HOLD THE SPEAKER/MICROPHONE APPROXIMATELY TWO INCHES FROM LIPS AND SPEAK TOWARD THE GRILL IN NORMAL VOLUME VOICE. IT ISN'T NECESSARY TO SHOUT (EVEN AT NOISY LOCATIONS) AND YOU WILL BE BETTER UNDERSTOOD.
4. AVOID UNNECESSARY CONVERSATION SO OTHERS CAN USE THE RADIO CHANNEL.
5. IT IS AGAINST THE LAW TO USE PROFANE LANGUAGE AND THE CHANNEL MIGHT BE HEARD IN OFFICES.

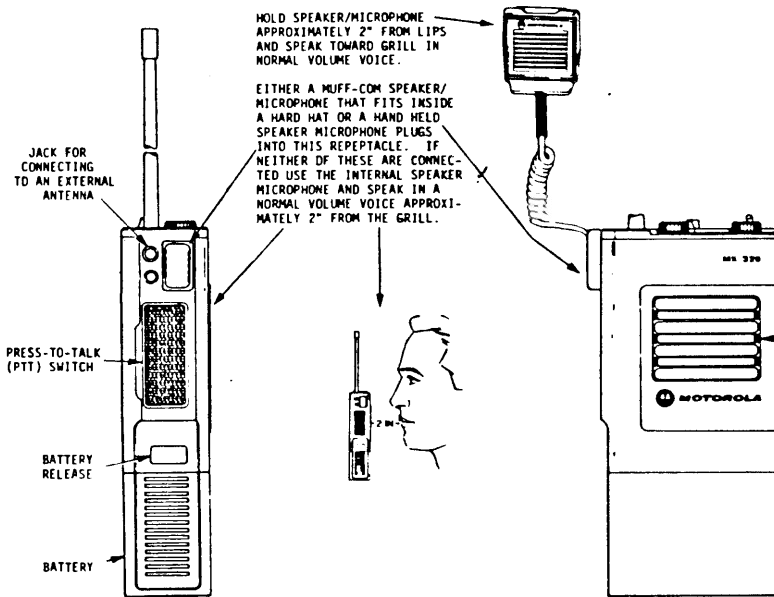

JERRY BENTZ, MOTOROLA PROJECT LEADER, DEMONSTRATING HOW TO SPEAK TO A MICROPHONE. HE WILL BE GLAD TO ANSWER YOUR QUESTIONS ABOUT THE RADIO SYSTEM.

**HOW TO REPLACE BATTERY**

1. TURN THE RADIO OFF.
2. HOLD THE RADIO IN THE LEFT HAND AND PRESS THE BATTERY RELEASE BUTTON WITH THE LEFT THUMB.
3. ROTATE THE BATTERY ABOUT 180 DEGREES, UNTIL THE CAM LOCK IS CLEAR, AND REMOVE THE BATTERY.
4. TO REPLACE THE BATTERY, REVERSE THE PROCEDURE. FIRST ENGAGE THE CAM LOCK, THEN ROTATE THE BATTERY CLOCKWISE UNTIL IT LATCHES IN THE PROPER POSITION. BE SURE THE BATTERY ENGAGES THE SLOT ON THE BOTTOM OF THE RADIO.
5. BATTERIES CAN BE RECHARGED EITHER WHILE IN THE RADIO OR WHEN THEY HAVE BEEN REMOVED. BATTERIES SHOULD BE RECHARGED AFTER EACH SHIFT.
6. **WARNING:** DO NOT DISCARD DEFECTIVE BATTERIES IN FIRE.

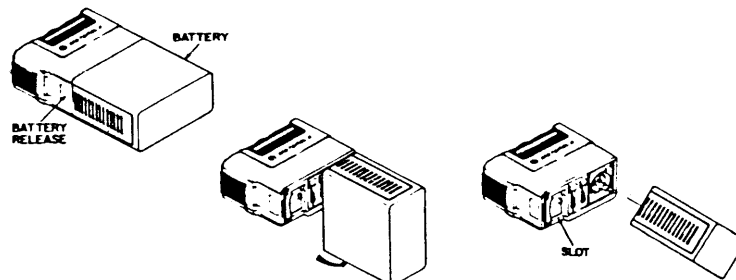

## 5.0 Project Management

Comsul was awarded the contract to provide engineering and administrative services necessary to design, procure material, test and supervise installation, maintain and document an emergency/non-emergency communications system in the Black River Mine which was selected by the Bureau as a likely location for demonstrating such a system.

Comsul Ltd. selected Don Parrish, Senior Consultant, to represent them as project manager early into the project in 1977. In this capacity he supervised the activities of Mr. R. A. Isberg, P.E., Radio Engineer. Mr. Parrish maintained the records, began financial reports, provided the Bureau of Mines with monthly reports, conducted field trips to the Black River Mine and coordinated Consul Ltd.'s role in all studies.

In February 1980, Mr. Kramer assisted Mr. Parrish in these essential administrative matters. This additional management support did not increase costs of Consul's professional services to the Bureau of Mines. Mr. Kramer developed an accurate inventory of all communications facilities at the Black River Mine. He also developed effective procedures for procurement and materials cost control. The monthly administrative and financial reports have been produced by him since he assumed the day to day administration of the project.

Mr. Kramer supervised Mr. Isberg's activities and made field trips to the mine for procedural and inventory purposes. He also administered payment of invoices including the subcontractor, Motorola.

### 5.1 Project Leader - Installation and Maintenance

The Bureau of Mines selected Motorola as the source for the radio and TV equipment. They provided a technician, Mr. Jerry Bentz, to serve as project leader. He began serving on the project in March of 1979 and performed the installation and maintenance functions to date.

## 5.2 Radio Equipment Costs

All of the radio equipment, cabinets, transmission lines, antennas, etc., and the installation of same were funded by the Bureau of Mines. Our calculations based upon our inventory and purchasing documents indicates the radio system cost approximately \$230,000.

## 5.3 Radio Licenses

Motorola Communications & Electronics was helpful in obtaining radio licenses from the FCC. During subsequent periods after the licenses were issued it became necessary to request certain revisions from the FCC. Additional locations, for example, were required for the control stations. It was necessary to license the underground stations as well as the above ground stations and at one point in time the FCC had switched some frequencies. All these changes and adjustments were covered with the FCC.

One additional radio license was issued to the Project Engineer for "Experimental Radio Construction Permit & License". This covered research on the signal booster system.

## 5.4 CCTV Costs

All of the TV equipment, cabinets, cables, etc., and installation costs were funded by the Bureau of Mines.

Our calculations based upon our inventory and purchasing documents indicate that the TV system cost approximately \$36,200.

## 5.5 Purchasing, Receiving and Inventory Systems

Procedures for effective control of purchasing, receiving and inventory were developed and implemented by Comsul Ltd. These procedures greatly facilitated ongoing inventory control. The purchasing procedure enabled Comsul

to know who was purchasing what, when and why. The receiving procedure provided input for our inventory and as a side benefit identified response time of the various vendor sources.

## 5.6 Cost and Safety Benefits to the Mine

Since the project was administered and funded by the Department of the Interior, U. S. Bureau of Mines the vast majority of costs were funded by them. Expense to the mine in accordance with a standard mutual assistance agreement was confined to man hours performing installation of certain cables and the use of some mine vehicles and equipment. Actually, expenses to the mine have been computed at \$30,000.

Interviews were conducted with key mine personnel who use the new radio and CCTV systems on a regular basis. Mr. William Day, Underground Maintenance Coordinator, declared he saved about two hours per day locating maintenance people by using the radio system. Prior to the implementation of the radio system, he was required to walk or when possible drive throughout the mine to locate the person or persons needed. Also, when the telephone system is busy, the radio system provides them with back up communications.

Another expense savings has been realized when mine equipment breaks down. The miners can call the maintenance people using the radio system and describe in some detail what the problem is before the maintenance man is dispatched. The maintenance man can then take the tools and parts required instead of making two trips.

Mr. Benny Whitmer, Safety Supervisor, stated that the mine has two fire drills per year for everyone in the mine. The radio system has reduced the time for these drills from 30 minutes to 12 minutes. In addition to the obvious improvement in response time the side benefit was a reduction in payroll costs for the fire drills for 40 men at an average of \$7.00 per hour using 12 minutes instead of 30 minutes for the fire drills. He also said the radio system could cut considerable time in getting an injured man out of the mine and into a hospital.

He also commented on the safety value of the radio system and CCTV system concerning the slope car, the two way speech to the winch operator and the TV coverage at the foot of the slope. When he is in his office above ground he monitors all three channels of the radio system on three different speakers, giving him the jump on any emergencies. One man smashed his hand, used his emergency call and was helped immediately. Mr. Dick Wehrmeyer, Electrical Engineer, indicated a time savings in locating the day shift electrician who could be in any part of the mine area underground or above ground. He can be reached on the radio system, speak directly to the person reporting the problem saving trips into and out of the mine.

The hoist house operator, who is the designated monitor of slope activity, stated that using the radio system for voice communication provides a whole new gamut of stops for the slope car that were not possible before. This is because he is able to maintain continuous and immediate communication with personnel in the slope car and can make unscheduled stops.

The radio system is vital when they are lowering large equipment into the mine down the slope. They have much more control to stop or start preventing damage to equipment or cables and reducing danger to support people.

The CCTV system provides the hoist operator with TV monitors to monitor the base of the slope for safety and to prevent lowering the slope car too far. He also monitors conveyor belt crossovers. The TV system has reduced belt breakage considerably because of monitoring. Restringing new conveyor belts has been much quicker using the radio system to coordinate activities between crews.

When the slope car is being raised or lowered the radio system has saved time and damage because all action can be stopped by radio when the car jumps the rails. This prevents damage to the conveyor belt system, danger to personnel, and alerts the hoist house operator before the slope car gets too far off the track.



## 5.7 Recommendations to Other Mine Owners

Radio systems and TV systems whether designed for production improvement or for personal safety of the miners must meet three requirements. The first, after design and installation have been completed, is management. Someone must be responsible for the ongoing performance of the entire system on a daily basis. This person should have a firm belief in the values of the system and at least rudimentary technical expertise. His role should be that of a central hub for all input on the status of the system and associated equipment. He would arrange for maintenance, repair and replacement of any part of the system.

Second, and every bit as important as the first, is the end user must be trained in the proper use, care and maintenance reporting procedures established. It has been our experience that the user didn't have any idea to whom he should report a problem on his unit. Visual aids such as prominently displayed posters, paycheck inserts, safety meetings or new employee introductory meetings could be used as periodic reminders. When his dependence on the radio system is channelled toward safety and communications rather than production goals he can relate to the systems value more readily.

Thirdly, the real weak link in the chain, maintenance. If the system or segments of the system such as hand held transceivers break down and are not repaired in relatively short time faith in, or dependence on, the system erodes and further acceptance is destroyed. A regular maintenance prevention program should be considered and qualified in-house radio technicians or service companies should be utilized.

## 5.8 Recommendations for Future U.S.B.M. Research

1. Further development of the signal booster concept is needed before it can be extended into hazardous areas such as coal mines or gassey metal/nonmetal operations.
2. A follow-on independent evaluation will be necessary to compliment this installation work.
3. Further development of lightweight portable signal margin measuring equipment should be pursued.

4. The Tx/Rx signal booster system that is being installed by Motorola in a room and pillar coal mine in southern Illinois promises to afford many advantages over systems using conventional base/mobile relay stations and distributed or leaky antennas.
5. The Ariadne daisy chain system with IF return that has been developed in England should be tested in a mine where intrinsically safe requirements apply.

## 5.9 Pending Tasks

Several items not covered elsewhere in this report that need to be further addressed are:

1. Maintenance - A contract with a reputable service company or in-house employee has not yet been resolved.
2. MODAT reporting system - All the units involved in this service have not as yet been installed, tested and brought into use by the Black River Mine.
3. Records of performance - Accurate records of performance of the entire system and individual components should be kept on a regular basis.
4. Signal Booster System - This part of the project has not yet been completed as far as assembly is concerned and therefore the concept has not had a field test to observe its practicality.

## REFERENCES

1. History of Project and Progress Report on Implementation of UHF Radio System in the Black River Mine, Comsul Ltd. Report to the Bureau of Mines TPO, Pages 2 and 3, December 1979.
2. Isberg, R.A. and R.L. Chufu, "Passive Reflectors as a Means for Extending UHF Signals Down Intersecting Crosscuts in Mines or Large Corridors", 28th Conference Record IEEE Vehicular Technology Society, March 1978.
3. History of Project and Progress Report on Implementation of UHF Radio System in the Black River Mine, Comsul Ltd. Report to the Bureau of Mines TPO, Pages 4 and 5, December 1979.
4. History of Project and Progress Report on Implementation of UHF Radio System in the Black River Mine, Comsul Ltd. Report to the Bureau of Mines TPO, Figures 1 - 4, December 1979.
5. Lagace, Robert L. and Alfred G. Emslie, "Propagation of UHF Radio Waves in Limestone Room and Pillar Mines", Arthur D. Little, Inc., Bureau of Mines Report for J0387217.
6. Proposed Radio System for the Black River Mine, Comsul Report to Bureau of Mines TPO, March 1978.
7. Proposal for Black River Mining Company Project, Motorola Communications and Electronics, Inc., July 6, 1978.
8. Proposed Radio System for Black River Mining Company, Comsul Ltd. Report to Bureau of Mines TPO, August 4, 1978.
9. Bureau of Mines Purchase Order No. P0382795 for Radio Equipment for the Black River Mine, September 8, 1978.
10. Report No. M092479 "RF Hazards to Electrical Blasting Caps at Black River Mine", MSHA Mine Electrical Systems Branch, 4800 Forbes Avenue, Pittsburgh, PA 15213.
11. I.M.E. No. 20 Safety Guide for the Prevention of Radio Frequency Radiation Hazards in the Use of Electrical Blasting Caps, October 1978.
12. Inventory of Government Furnished Radio and CCTV Equipment in the Black River Mine, Comsul Ltd. Report to the Bureau of Mines TPO, June 1979.
13. Proposed Environmental Monitoring and Uninterruptible Power Systems For the Black River Mine, Comsul Ltd. Preliminary Report to Bureau of Mines TPO, July 1980.
14. Suzuki, T., Tetsoro Hanazawa and Shigerv Kozono, "Design of Tunnel Relay System With a Leaky Coaxial Cable in an 800 MHz Land Mobile Telephone System", IEEE Transactions on Vehicular Technology, Vol. VT-29, No. 3, August 1980.

## REFERENCES (Continued)

15. Fisher, Jack, "A Unique Multichannel Two Way UHF Radio Signal Booster System for Leaky Transmission Lines in Mines", IEEE 31st Vehicular Technology Conference, April 1980.
16. Isberg, R.A., P.E., "Evaluation of C-COR CATV Distribution Amplifier as a Signal Booster for VHF Radio Systems", Comsul Ltd. Report to Bureau of Mines TPO, September 1980.
17. Isberg, R.A., P.E., "A Study of the Technology of Underground Radio Communication in Europe", 1980 Rapid Transit Conference, American Public Transit Assn., June 1980.
18. Report No. M092479 "RF Hazards to Electrical Blasting Caps at Black River Mine", MSHA, Mine Electrical Systems Branch, 4800 Forbes Avenue, Pittsburgh, PA 15213.
19. I.M.E. No. 20 Safety Guide for the Prevention of Radio Frequency Radiation Hazards in the Use of Electrical Blasting Caps, October 1978.

Miscellaneous References Acquired During Research of Technology of Underground Communication.

### Papers in English Language

1. Martin, D.J.R., ARIADNE: A Radio Propagation Highway for Mines, 1980 National Telecommunications Conference, December 1980.
2. Martin, D.J.R., and R.W. Haining, Leaky Feeder Radio Techniques for Mines and Tunnels, presented at I.E.R.E. Land Mobile Radio Conference, Lancaster, September 1979.
3. Martin, D.J.R., Radio Communications in Mines, The Mining Engineer January 1978.
4. Delogne, Paul, Subsurface Radio Communications, I.E.E.E. Spectrum 1980.
5. Delogne, Paul, Mode Converters for HF Tunnels Transmission, Translation of Unidentified Source.
6. Delogne, Paul, Basic Mechanisms of Tunnel Propagation, Radio Science, Vol. 11, No. 4, April 1976.
7. Delogne, P., Radio Communication System for Confined Spaces, U.S. Patent 4,152,648, May 1, 1979.
8. Delogne, P., Radio Communications System for Use in Confined Spaces and the Like, U.S. Patent 3,829,767, August 13, 1974.

## REFERENCES (Continued)

9. Bosshard, A., Radio Links for Highway Tunnels, Communications International, May 1979.
10. Grussi, O., and Peter Konig, Radio Links for Highway Tunnels, Bulletin Technique PTT, July 1978.
11. Wey, E., NATEL, The Swiss Automobile Telephone Network, Technische Mitteilungen PTT, 1979. (Translation)

### Papers in Other Languages

1. Meyer, H.R., Funkversorgung Services Radio electriques, PTT December 1980.
2. Delogne, P. Les Telecommunications par Radio en Milieu Souterrain, unidentified source.
3. Block Diagrams and Description (in German) of Radio System In Gotthard Tunnel in Switzerland.
4. Verkehrsleitsystem Autophon, Jruzbeschreibung des Anlagenkonzeptes, Autophon AG, August 28, 1979.
5. Baumann, A., Breitbandverstarker fur Tunnelfunk TUG 55 F, Autophon AG, September 10, 1979.
6. Tunnelverstarker, TUG 55 F bzw. TUV 55 F, Autophon AG, September 12, 1979.
7. Ergänzende Messungen am Strahlenden, Koaxialkabel Typ S 17873 der Fa. Huber & Suhner AG, PTT Report, July 4, 1978.
8. Wey, E., NATEL, das Schweizerische Autotelefonnetz, Technische Mitteilungen PTT, 1979.
9. Grussi, O., Statistische Messungen der Feldstarkeverteilung bei Fahrzeug-Telephonanlagen, Technische Mitteilungen, 1970.

APPENDIX A

FCC RADIO LICENSES FOR BLACK RIVER MINING COMPANY

| PAGE | CALL SIGN | CHANNEL                | FREQUENCY | TRANSMITTER LOCATION       |
|------|-----------|------------------------|-----------|----------------------------|
| 1    | WYK-240   | 1 Above Ground         | 451.950   | Radio Room in Office Bldg. |
|      | WYK-240   | 2 " "                  | 452.175   | " " " " "                  |
| 2    | WYK-242   | 3 Slope                | 452.025   | " " " " "                  |
| 3    | WYK-241   | 1 Under Ground         | 451.950   | Monitor Room in Mine       |
|      | WYK-241   | 2 " "                  | 452.175   | " " " "                    |
|      | WYK-241   | 1 " "                  | 451.950   | Near Crusher No. 3         |
|      | WYK-241   | 2 " "                  | 452.950   | " " " "                    |
| 4    | WFJ-985   | 3 Above Ground         | 457.025   | Warehouse Control Station  |
|      | WFJ-985   | 2 " "                  | 457.175   | " " "                      |
|      | WFJ-985   | 1 " "                  | 456.950   | " " "                      |
| 5    | WFJ-984   | 1 Under Ground         | 456.950   | Bottom of Slope Control    |
|      | WFJ-984   | 2 " "                  | 457.175   | " " " "                    |
| 6    | WFE-459   | 1 Under Ground         | 456.950   | Foreman's Shop Control     |
|      | WFE-459   | 2 " "                  | 457.175   | " " "                      |
| 7    | KA-40145  | 1 Above & Under Ground | 456.950   | Mobiles and Portables      |
|      | KA-40145  | 2 " "                  | 457.175   | " " "                      |
|      | KA-40145  | 3 " "                  | 457.025   | " " "                      |

DO NOT WRITE IN THIS BLOCK

APPROVED BY GAO  
B-180227 (R0389)

United States of America  
Federal Communications Commission

Call Sign **W Y K 2 4 0 (new)** File No. **7313-IS-19**

Antenna painting and lighting specifications: **FCC Form 1023 attached**

Special Conditions:

This authorization effective **March 29, 1979**  
and will expire **3:00 AM EST. March 29, 1984**

and is subject to further conditions as set forth on reverse side. If the station authorized herein is not placed in operation within eight months this authorization becomes invalid and must be returned to the Commission for cancellation unless an extension of completion date has been authorized.

**gunn/ls** Federal Communications Commission

Chief, Safety & Special Radio Services Bureau

**Special Industrial**

6(a) Name of Radio Service  Base  Mobile  Other  **Temp. Mobile Relay**

7(a) Name (see instructions)

**Black River Mining Company**

(b) Mailing address (number, street, city, state & zip code)

**Route 8  
Butler, Kentucky 41006**

| 1(a). Frequencies<br>MHz | 1(b). No. of transmitters |        |       | 1(c). Emission | 1(d). Output Power<br>Watts |
|--------------------------|---------------------------|--------|-------|----------------|-----------------------------|
|                          | Base-Land-Fixed           | Mobile | Other |                |                             |
| 451.950                  |                           |        | 2     | 20F3           | 12                          |
| 452.175                  |                           |        | 2     | 20F3           | 12                          |

1(e) Show No. of mobile units in each of following categories: Land vehicle \_\_\_\_\_, aircraft \_\_\_\_\_, hand carried \_\_\_\_\_, marine \_\_\_\_\_, paging \_\_\_\_\_, receiver \_\_\_\_\_

2. Location of transmitter(s) at a fixed location

Number and street (or other indication of location)

City \_\_\_\_\_ County \_\_\_\_\_ State \_\_\_\_\_

Latitude \_\_\_\_\_ Longitude \_\_\_\_\_

3. Location of control point(s)

KA40145 WFE459 WFJ984 WFJ985

4. If mobile units, or other class of station, are included in this authorization, show area of operation.

**Black River Mine Complex above & below ground, & 5 mile radius of**

5(a). Overall height above ground of \_\_\_\_\_ ft. (2) antenna supporting structure \_\_\_\_\_ ft.

(1) tip of antenna \_\_\_\_\_ ft.

(b). Elevation of ground above mean sea level at antenna site \_\_\_\_\_ ft.

BASE/MOBILE RELAY STATIONS ABOVE GROUND

DO NOT WRITE IN THIS BLOCK

APPROVED BY GAO  
B-180227 (R0389)  
AUTHORIZATION

United States of America  
Federal Communications Commission

Call Sign WYK 2 4 2 (new) File No. 7314-IS-19

Antenna painting and lighting specifications.  
Special Conditions.

This authorization effective March 29, 1979  
and will expire 3:00 AM EST March 29, 1984

and is subject to further conditions as set forth on reverse side. If the station authorized herein is not placed in operation within eight months this authorization becomes invalid and must be returned to the Commission for cancellation unless an extension of completion date has been authorized.

gmm/1s  
Federal Communications Commission  
Chief, Safety & Special Radio Services Bureau

6(a) Name of Radio Service SPECIAL INDUSTRIAL  
6(b) Class of station: Base  Mobile  Other  MOBILE RELAY

7(a) Name (see instructions)  
Black River Mining Company  
(b) Mailing address (number, street, city, state & zip code)  
Route 8  
Butler, Kentucky 41006

1(a) Frequencies MHz 452.025

1(b) No. of transmitters:  
Base Land-Fixed \_\_\_\_\_ Mobile 1 Other \_\_\_\_\_

1(c) Emission 20F3

1(d) Output Power Watts 12

1(e) Show No. of mobile units in each of following:  
categories: Land vehicle \_\_\_\_\_ aircraft \_\_\_\_\_  
hand carried \_\_\_\_\_ marine \_\_\_\_\_ paging \_\_\_\_\_ receivers \_\_\_\_\_

2. Location of transmitter(s) at a fixed location  
Number and street (or other indication of location)  
City Butler County Pendleton State KY  
Latitude 38 ° 50 ' 26 " N Longitude 84 ° 14 ' 34 " W

3. Location of control point(s)  
KA40145 WFJ985

4. If mobile units, or other class of station at temporary locations, are included in this authorization, show area of operation.

5(a). Overall height above ground of:  
(1) tip of antenna 22 ft. (2) antenna supporting structure 20 ft.  
(b). Elevation of ground above mean sea level at antenna site 520 ft.

BASE/MOBILE RELAY STATION FOR SLOPE COMMUNICATION



FCC Form 409  
APRIL 1974

APPROVED BY GAO  
B-180227 (R0389)

AUTHORIZATION

United States of America  
Federal Communications Commission

DO NOT WRITE IN THIS BLOCK

Call Sign **WYK 241 (new)** File No. **7312-IS-19**

Antenna painting and lighting specifications:

Special Conditions:

1(d) Output Power Watts

1(c) Emission

1(b) No. of transmitters

Base-Land-Fixed

Mobile

Other

12  
12

20F3  
20F3

2  
2

1(a) Frequencies  
MHz  
451.950  
452.175

This authorization effective **March 29, 1979**  
and will expire **3:00 AM EST. March 29, 1984**

and is subject to further conditions as set forth on reverse side. If the station authorized herein is not placed in operation within eight months this authorization becomes invalid and must be returned to the Commission for cancellation unless an extension of completion date has been authorized.

8mm/1S Federal Communications Commission



Chief, Safety & Special Radio Services Bureau

1(c) Show No. of mobile units in each of following categories: Land vehicle \_\_\_\_\_ aircraft \_\_\_\_\_  
hand carried \_\_\_\_\_ marine \_\_\_\_\_ piping \_\_\_\_\_ receivers \_\_\_\_\_

2 Location of transmitter(s) at a fixed location

Number and street (or other indication of location) **Mine Complex Interconnect**

City **Butler** County **Pendleton** State **Kentucky**

Latitude **38° 50' 26" N** Longitude **84° 14' 31" W**

3 Location of central point(s)

**KA40145 WFE459 WJ984 WJ985**

4. If mobile units, or other class of station at temporary locations, are included in this authorization, show area of operation.

5(a). Overall height above ground of

(1) tip of antenna **25'** ft. (2) antenna supporting structure **20'** ft.

(b). Elevation of ground above mean sea level at antenna site **520'** ft.

6(a) Name of Radio Service **SPECIAL INDUSTRIAL**

6(b) Class of station:

Base  Mobile  Other  MOBILE RELAY

7(a) Name (see instructions)

**BLACK RIVER MINING COMPANY**

(b) Mailing address (number, street, city, state & zip code)

**Route 8  
Butler, Kentucky 41006**

BASE/MOBILE RELAY STATIONS UNDER GROUND

DO NOT WRITE IN THIS BLOCK

APPROVED BY GAO  
B-180227 (R0389)

United States of America  
Federal Communications Commission

Call Sign **W F J 9 8 5 (new)** File No. **7310-IS-19**

Antenna painting and lighting specifications:  
Special Conditions:

This authorization effective **March 29, 1979**  
and will expire **3:00 AM EST. March 29, 1984**  
and is subject to further conditions as set forth on reverse side. If the station authorized herein is not placed in operation within eight months this authorization becomes invalid and must be returned to the Commission for cancellation unless an extension of completion date has been authorized.

**gmm/1s** Federal Communications Commission  
Chief, Safety & Special Radio Services Bureau

6(a) Name of Radio Service **SPECIAL INDUSTRIAL**  
6(b) Class of station: Base  Mobile  Other  **CONTROL STATIONS**

7(a) Name (see instructions)  
**Black River Mining Company**  
(b) Mailing address (number, street, city, state & zip code)  
**Route 8  
Butler, Kentucky 41006**

| 1(a) Frequencies<br>MHz | 1(b) No. of transmitters |        |       | 1(c) Emission | 1(d) Output Power<br>Watts |
|-------------------------|--------------------------|--------|-------|---------------|----------------------------|
|                         | Base-Land-Fixed          | Mobile | Other |               |                            |
| 457.025                 |                          |        | 1     | 20F3          | 15                         |
| 457.175                 |                          |        | 1     | 20F3          | 15                         |
| 456.950                 |                          |        | 1     | 20F3          | 15                         |

1(e) Show No. of mobile units in each of following categories: Land vehicle \_\_\_\_\_, aircraft \_\_\_\_\_, paging \_\_\_\_\_, hand carried \_\_\_\_\_, marine \_\_\_\_\_, receivers \_\_\_\_\_.

2 Location of transmitter(s) at a fixed location:  
Number and street (or other indication of location) **Mine Warehouse**  
City **Butler** County **Pendleton** State **KY**  
Latitude **38 50 19 N** Longitude **84 14 29 W**

3 Location of control point(s)  
**Same as transmitter**

4. If mobile units, or other class of station at temporary locations, are included in this authorization, show area of operation.

5(a). Overall height above ground of  
(1) tip of antenna **22** ft. (2) antenna supporting structure **20** ft.  
(b). Elevation of ground above mean sea level at antenna site **500** ft.

CONTROL STATION IN WAREHOUSE ABOVE GROUND

APPROVED BY GAO  
B-180227 (R0389)  
AUTHORIZATION

United States of America  
Federal Communications Commission

DO NOT WRITE IN THIS BLOCK  
Call Sign **W F J 9 8 4 (new)** File No. **7309-IS-19**

| 1(a) Frequencies<br>MHz | 1(b) No. of transmitters |        | 1(c) Emission | 1(d) Output Power<br>Watts |
|-------------------------|--------------------------|--------|---------------|----------------------------|
|                         | Base-Land-Fixed          | Mobile | Other         |                            |
| 456.950                 |                          |        | 1<br>20F3     | 15                         |
| 457.175                 |                          |        | 1<br>20F3     | 15                         |

11(a) Show No. of mobile units in each of following categories: Land vehicle \_\_\_\_\_, aircraft \_\_\_\_\_, paging \_\_\_\_\_, marine \_\_\_\_\_, receivers \_\_\_\_\_

2 Location of transmitter(s) at a fixed location  
 Number and street (or other indication of location) **Mine Air Shaft**  
 City **Butler** County **Pendleton** State **KY**  
 Latitude **38 50 06 N** Longitude **84 14 53 W**

3 Location of control point(s)  
**Same as transmitter**

4. If mobile units, or other class of station at temporary locations, are included in this authorization, show area of operation.

5(a). Overall height above ground of  
 (1) tip of antenna **22'** (2) antenna supporting structure **20'**  
 (b) Elevation of ground above mean sea level at antenna site **520** ft.

Antenna painting and lighting specifications:  
 Special Conditions:

This authorization effective **March 29, 1979**  
 and will expire **3:00 AM EST. March 29, 1984**

and is subject to further conditions as set forth on reverse side. If the station authorized herein is not placed in operation within eight months this authorization becomes invalid and must be returned to the Commission for cancellation unless an extension of completion date has been authorized.

**gmm/l's** Federal Communications Commission  
 Chief, Safety & Special Radio Services Bureau

6(a) Name of Radio Service **SPECIAL INDUSTRIAL**  
 (b) Class of station: Base  Mobile  Other  **CONTROL STATION**

7(a) Name (see instructions)  
**Black River Mining Company**  
 (b) Mailing address (number, street, city, state & zip code)  
**Route 8  
 Butler, Kentucky 41006**

CONTROL STATION NEAR BASE OF SLOPE

DO NOT WRITE IN THIS BLOCK

FCC Form 400  
APRIL 1978

United States of America  
Federal Communications Commission

APPROVED BY GAO  
B-180227 (R0389)

AUTHORIZATION

Call Sign **WFE 459 (new)** File No. **7311-IS-19**

Antenna painting and lighting specifications. **FCC Form 1023 attached**

Special Conditions:

1(a). Frequencies  
MHz

1(b). No. of transmitters

Base-Land-Fixed

Mobile

Other

1(c). Emission

1(d). Output Power Watts

|         |  |  |   |      |    |
|---------|--|--|---|------|----|
| 456.950 |  |  |   | 20F3 | 20 |
| 457.175 |  |  | 3 | 20F3 | 20 |

1(e). Show No. of mobile units in each of following categories: Land vehicle \_\_\_\_\_ aircraft \_\_\_\_\_  
hand carried \_\_\_\_\_ marine \_\_\_\_\_ paging \_\_\_\_\_ receivers \_\_\_\_\_

2. Location of transmitter(s) at a fixed location  
Number and street (or other indication of location)

CITY \_\_\_\_\_ County \_\_\_\_\_ State \_\_\_\_\_

Latitude \_\_\_\_\_ Longitude \_\_\_\_\_

3. Location of control point(s)

same as transmitter

4. If mobile units, or other class of station at temporary locations, are included in this authorization, show area of operation. **Black River Mine Complex**

**above 5 miles around 3 mile radius of**

Butler, Kentucky

(1) tip of antenna \_\_\_\_\_ ft. (2) antenna supporting structure \_\_\_\_\_ ft.

(b). Elevation of ground above mean sea level at antenna site \_\_\_\_\_ ft.

This authorization effective **March 29, 1979**  
and will expire **3:00 AM EST March 29, 1984**

and is subject to further conditions as set forth on reverse side. If the station authorized herein is not placed in operation within eight months this authorization becomes invalid and must be returned to the Commission for cancellation unless an extension of completion date has been authorized.

8mm/1s Federal Communications Commission



Chief, Safety & Special Radio Services Bureau

6(a) Name of Radio Service **Special Industrial**  
6(b) Class of station: Base  Mobile  Other  Temporary Control

7(a) Name (see instructions)

**Black River Mining Company**

(b) Mailing address (number, street, city, state & zip code)  
**Route 8**  
**Butler, Kentucky 41006**

CONTROL STATION IN MINE SHOP

DO NOT WRITE IN THIS BLOCK

APPROVED BY GAO  
B-180227 (R0389)  
AUTHORIZATION

United States of America  
Federal Communications Commission

Call Sign **K A 4 0 1 4 5 (new)** File No **7308-IS-19**

Antenna painting and lighting specifications:  
Special Conditions:

This authorization effective **March 29, 1979**  
and will expire **3:00 AM EST, March 29, 1984**  
and is subject to further conditions as set forth on reverse side. If the station authorized herein is not placed in operation within eight months this authorization becomes invalid and must be returned to the Commission for cancellation unless an extension of completion date has been authorized.

**ghm/lr** Federal Communications Commission  
Chief, Safety & Special Radio Services Bureau

| 1(a) Frequencies<br>MHz | 1(b) No of transmitters |              | 1(c) Emission | 1(d) Output Power<br>Watts |
|-------------------------|-------------------------|--------------|---------------|----------------------------|
|                         | Base Land-Fixed         | Mobile Other |               |                            |
| 456.950                 |                         | 11           | 20F3          | 6                          |
| 451.950                 |                         | 11           | 20F3          | 6                          |
| 457.175                 |                         | 17           | 20F3          | 2                          |
| 452.175                 |                         | 17           | 20F3          | 2                          |
| 457.025                 |                         | 1            | 20F3          | 6                          |

11) Show No. of mobile units in each of following: **12**

car/pool: Land vehicle \_\_\_\_\_ aircraft \_\_\_\_\_  
hand carried: **17** marine \_\_\_\_\_ paging \_\_\_\_\_  
receivers \_\_\_\_\_

2. Location of transmitter(s) as a fixed location: \_\_\_\_\_

Number and street (or other indication of location): \_\_\_\_\_

City \_\_\_\_\_ County \_\_\_\_\_ State \_\_\_\_\_

Latitude \_\_\_\_\_ Longitude \_\_\_\_\_

3. Location of control point(s): \_\_\_\_\_

4. If mobile units, or other class of station at temporary locations, are included in this authorization, show area of operation: **Black River Mine Complex Above & Below Ground & 5 mile radius of**

5(a). Overall height above ground of \_\_\_\_\_ ft. (2) antenna supporting structure **Butler, Kentucky** ft.  
(b). Elevation of ground above mean sea level at antenna site \_\_\_\_\_ ft.

6(a) Name of Radio Service **SPECIAL INDUSTRIAL**  
(b) Class of station: Base  Mobile  Other

7(a) Name (see instructions) **Black River Mining Company**  
(b) Mailing address (number, street, city, state & zip code)  
**Route 8  
Butler, Kentucky 41006**

MOBILE AND PORTABLE STATIONS

APPENDIX B  
 EXPERIMENTAL RESEARCH LICENSE FOR  
 TESTING SIGNAL BOOSTER AMPLIFIERS IN THE MINE

FCC Form 450-B  
 May 1976

1215 Henry st. Berkeley, Calif. 94709

UNITED STATES OF AMERICA  
 FEDERAL COMMUNICATIONS COMMISSION  
 EXPERIMENTAL

RADIO STATION CONSTRUCTION PERMIT  
 EXPERIMENTAL (RESEARCH) AND K K 2 X C A (new)  
 (Nature of service) LICENSE (Call sign)  
 CONTRACT DEVELOPMENTAL XC FX 8108-EP-PL-89  
 (Class of station) (File number)

NAME R. A. ISBERG, P.E.

Butler (Pendleton) Kentucky - Lat. 38 50 26 N; Long. 84 14 31 W.  
 (Location of station)

(Location of authorized remote control point)

Subject to the provisions of the Communications Act of 1934, subsequent acts, and treaties, and all regulations heretofore or hereafter made by this Commission, and further subject to the conditions and requirements set forth in this license, the licensee hereof is hereby authorized to use and operate the radio transmitting facilities hereinafter described for radio communication.

| Frequency   | Emission Designator | Authorized Power (Watts) | Special Provisions |
|-------------|---------------------|--------------------------|--------------------|
| 451.950 MHz | 20F3                | 0.4 (ERP)                |                    |
| 452.175 MHz | 20F3                | 0.4 (ERP)                |                    |
| 456.950 MHz | 20F3                | 0.4 (ERP)                |                    |
| 457.175 MHz | 20F3                | 0.4 (ERP)                |                    |

Frequency Tolerance:  $\pm 0.0005\%$

Operation: In accordance with Sec. 5.202(c) of the Commission's Rules.

Special Conditions:

- (1) This authorization is issued for the express purpose of conducting experimental operations described in the related application and required by U.S. Department of Interior, Bureau of Mines Contract No. J0377044. The use of this radio station in any other manner or for any other purpose will constitute a violation of the privileges herein authorized.
- (2) Except as subsequently authorized by the Commission, this radio station shall not be operated after the expiration date of the contract designated in the related application and enumerated above.

The above frequencies are assigned on a temporary basis only and are subject to change at any time without hearing.

This authorization is granted subject to the condition that no harmful interference is caused to any other station or service and may be cancelled at any time without hearing if, in the judgment of the Commission, such action should be necessary.

This license is issued on the licensee's representation that the statements contained in licensee's application are true and that the undertakings therein contained, so far as they are consistent herewith, will be carried out in good faith. The licensee shall, during the term of this license, render such service as will serve public interest, convenience, or necessity to the full extent of the privileges herein conferred.

This license shall not vest in the licensee any right to operate the station nor any right in the use of the frequencies designated in the license beyond the term hereof, nor in any other manner than authorized herein. Neither the license nor the right granted hereunder shall be assigned or otherwise transferred in violation of the Communications Act of 1934. This license is subject to the right of use or control by the Government of the United States conferred by Section 606 of the Communications Act of 1934.

This authorization effective ... September 24, 1980 and will expire 3:00 A.M. EST ... August 1, 1982 .....

9-24-80

FEDERAL  
 COMMUNICATIONS  
 COMMISSION



F. C. C. - WASHINGTON, D. C.

## APPENDIX C

TABLE 2 SIGNAL MARGINS MEASURED AT BASE STATION ABOVE GROUND OF SIGNALS FROM TWO WATT TRANSCEIVER OPERATED IN A PICKUP TRUCK.

TABLE 3 SIGNAL MARGINS MEASURED AT BASE STATION IN RADIO AND MONITORING EQUIPMENT ROOM OF SIGNALS FROM TWO WATT TRANSCEIVER OPERATED ON TRACTOR IN WESTERN HALF OF THE MINE.

TABLE 4 SIGNAL MARGINS MEASURED AT BASE STATION IN RADIO AND MONITORING EQUIPMENT ROOM OF SIGNALS FROM TWO WATT TRANSCEIVER OPERATED ON TRACTOR IN EASTERN HALF OF THE MINE.

TABLE 2

## SIGNAL MARGINS MEASURED ABOVE GROUND ON THE BLACK RIVER MINE PROPERTY

These measurements of signals from a two way transceiver were made at a base station receiver on January 28, 1981, during final acceptance tests of the radio system.

| <u>TEST LOCATION</u>                    | <u>MEASURED<br/>INPUT TO<br/>RECEIVER<br/>uV</u> | <u>SIGNAL MARGIN<br/>ABOVE 20 dBq<br/>(0.8 uV)<br/>dB</u> | <u>COMMENTS</u>  |
|---|--|---|------------------|
| Highway 8 and road to<br>the air shaft  | 100+   | 40+   | Excellent signal |
| Powder magazine                         | 6 - 10   | 16 - 20   | " "              |
| Walking around air shaft<br>hoist house | 5 - 9  | 14 - 19   | " "              |
| Walking near fans                       | 3 - 6  | 9 - 16  | " "              |
| Air shaft sub station                   | 5 - 9  | 14 - 19   | " "              |
| Riding past dump                        | 3 - 7  | 9 - 17  | " "              |
| Near cooling towers                     | 9 - 30   | 19 - 29   | " "              |
| Walking around lime kilns               | 6 - 50   | 16 - 34   | " "              |
| Mobile enroute to<br>warehouse          | 20 - 100   | 26 - 40   | " "              |
| In lime kiln buildings                  | 20 - 100   | 26 - 40   | " "              |
| On back side of kiln<br>building        | 5 - 12   | 14 - 22   | " "              |
| Near back door of kiln<br>building      | 6 - 14   | 16 - 23   | " "              |
| On second level of kiln<br>building     | 10 - 100   | 20 - 40   | " "              |



Table 3

SIGNAL MARGINS MEASURED IN WESTERN  
HALF OF THE MINE

These measurements of signals from a two-watt transceiver operated by a person riding on a tractor were made at a base station in the radio room on January 30, 1981 during final acceptance tests of the radio systems. The test locations are shown on Figure 3.24A page 76.

| <u>MINE<br/>COORDINATES<br/>OF TWO-WATT<br/>TRANSMITTERS</u> | <u>MEASURED<br/>INPUT TO<br/>RECEIVER<br/>uV</u> | <u>SIGNAL MARGIN<br/>ABOVE 20 dBq<br/>(0.8 uV) dB</u> | <u>COMMENTS</u>                       |
|--|--|---|---------------------------------------|
| 206/108  | 10-20  | 20-6  | Excellent                             |
| 207/108  | 2-5  | 6-14  | Satisfactory                          |
| 209/108  | 1-3  | 0-9   | Noisy                                 |
| 210/108  | 2-4  | 6-12  | Satisfactory                          |
| 211/108  | 2-4  | 6-12  | Slight Picketing                      |
| 214/108  | 3-5  | 9-14  | Satisfactory                          |
| 217/108  | 2-3  | 6-9   | Noisy                                 |
| 218/117  | 2-5  | 6-14  | Satisfactory                          |
| 218/117  | 1  | 0   | Moved 10', Transceiver unreadable     |
| 210/109  | 2-5  | 6-14  | Satisfactory                          |
| 212/109  | 3-6  | 9-16  | Satisfactory                          |
| 212/108  | 3-6  | 9-16  | Satisfactory                          |
| 206/105  | 2-5  | 6-14  | Good                                  |
| 199/105  | 1-3  | 0-9   | Noisy                                 |
| 198/105  | 2-5  | 6-14  | Good Received from Crusher 2 Receiver |
| 199/109  | 1-3  | 0-9   | Noisy                                 |
| 199/111  | 5-10   | 14-20   | Excellent Signal                      |
| 199/117  | 40-50  | 32-34   | Excellent Signal                      |
| 199/114  | 5-12   | 14-22   | Excellent Signal                      |
| 199/117  | 5-7  | 14-17   | Excellent Signal                      |
| 200/118  | 5-26   | 14-28   | Excellent Signal                      |
| 200/121  | 5-7  | 14-17   | Excellent Signal                      |
| 200/123  | 5-7  | 14-17   | Excellent Signal                      |
| 200/123  | 5-7  | 14-17   | Excellent Signal                      |
| 200/127  | 4-6  | 12-16   | Good Signal                           |
| 200/130  | 4-6  | 12-16   | Good Signal                           |
| 200/134  | 3-5  | 9-14  | Noisy                                 |
| 200/135  | 2-4  | 6-12 (future<br>booster location)                     | Noisy                                 |
| 200/137  | 2-4  | 6-12  | Noisy                                 |
| 200/140  | 2-4  | 6-12  | Good                                  |
| 200/142  | 3-6  | 9-12  | Good                                  |
| 200/143  | -  | -   | Noisy Not Readable Blank Area         |
| 200/145  | -  | -   | Noisy Not Readable Blank Area         |
| 197-124  | 1-3  | 0-9   | Noisy                                 |
| 197-118  | 20-29  | 26-29   | Excellent                             |
| 197-117  | 20-30  | 26-29   | Excellent                             |

| MINE<br>COORDINATES<br>OF TWO-WATT<br>TRANSMITTERS | MEASURED<br>INPUT TO<br>RECEIVER<br>uV | SIGNAL MARGIN<br>ABOVE 20 dBq<br>(0.8 uV) dB | COMMENTS                    |
|--|--|--|-----------------------------|
| 196/117  | 3-5                                    | 9-14   | Satisfactory                |
| 196/117  | 3-5                                    | 9-14   | Satisfactory                |
| 195/116  | 3-6                                    | 9-16   | Satisfactory                |
| 193/116  | 2-4                                    | 6-14   | Noisy                       |
| 193/115  | 2-4                                    | 6-14   | Noisy                       |
| 197/116  | 3-6                                    | 9-16   | Satisfactory                |
| 197/113  | 3-6                                    | 9-16   | Satisfactory                |
| 194/111  | 5-10                                   | 14-20  | Excellent                   |
| 193/111  | 3-5                                    | 9-14   | Excellent                   |
| 192/111  | 3-5                                    | 9-14   | Air Compressor<br>Excellent |
| 192/111  | 5-10                                   | 14-20  | Excellent                   |
| 189/111  | 3-5                                    | 9-14   | Excellent                   |
| 189/111  | 26-33                                  | 28-30  | Excellent                   |
| 189/108  | 3-5                                    | 9-14   | Excellent                   |
| 189/118  | 4-10                                   | 12-20  | Crusher<br>Excellent        |
| 189/105  | 4-10                                   | 12-20  | Excellent                   |
| 192/105  | 2-6                                    | 6-16   | Satisfactory                |
| 196/105  | 2-6                                    | 6-16   | Satisfactory                |
| 199/105  | 2-5                                    | 6-14   | Satisfactory                |
| 204/106  | 1-4                                    | 0-12   | Noisy                       |
| 204/102  | 24                                     | 27   | Base of Slope               |
| 206/105  | 33-100                                 | 30-40  | Under Antenna<br>Excellent  |
| 206/117  | 3-10                                   | 9-20   | Excellent                   |
| 208/117  | 4-10                                   | 12-20  | Excellent                   |
| 211/117  | 4-6                                    | 12-16  | Excellent                   |
| 210/117  | 4-6                                    | 12-16  | Excellent                   |
| 205/117  | 10-26                                  | 20-28  | Excellent                   |
| 205/120  | 4-6                                    | 12-16  | Excellent                   |
| 205/123  | 3-5                                    | 9-14   | Satisfactory                |

Table 4

SIGNAL MARGINS MEASURED IN EASTERN  
HALF OF THE MINES

| <u>MINE<br/>COORDINATES<br/>OF TWO-WATT<br/>TRANSMITTER</u> | <u>MEASURED<br/>INPUT TO<br/>RECEIVER<br/>uV</u> | <u>SIGNAL MARGIN<br/>ABOVE 20 dBq<br/>(0.8 uV)<br/>dB</u> | <u>COMMENTS</u>   |
|---|--|---|---|
| 189/110   | 100  | 40  | Excellent   |
| 189/113   | 100  | 40  | Excellent   |
| 189/117   | 100  | 40  | Excellent   |
| 189/122   | 25-60  | 28-35   | Excellent   |
| 189/123   | 10-20  | 20-26   | Excellent   |
| 189/125   | 20-80  | 26-38   | Excellent   |
| 189/130   | 5-10   | 14-20   | Excellent   |
| 189/132   | 5-10   | 14-20   | Excellent   |
| 189/136   | 4-7  | 12-17   | At The Face Scratchy But Satisfactory                   |
| 187/134   | 5-10   | 14-20   | Excellent   |
| 187/130   | 5-10   | 14-20   | Excellent   |
| 187/128   | 100  | 40  | Under Last Antenna                                      |
| 187/125   | 15-55  | 23-35   | Future Amplifier Location                               |
| 185/125   | 100  | 40  | Dust Hole Near Antenna                                  |
| 188/125   | 45-  | 33  | Excellent   |
| 187/123   | 60   | 35  | Excellent   |
| 185/123   | 10   | 20  | Excellent   |
| 183/123   | 5-10   | 14-20   | Excellent   |
| 181/123   | 3-5  | 9-14  | Scratchy But Satisfactory                               |
| 182/123   | 1-3  | 0-9   | Transceiver Battery Weak - Scratchy                     |
| 123/187   | 10-27  | 20-28   | Excellent   |
| 187/117   | 100+   | 40+   | Excellent   |
| 187/113   | 100+   | 40+   | Excellent   |
| Crusher 3   | 100+   | 40+   | Excellent   |
| 189/105   | 100+   | 40+   | Excellent   |
| 192/105   | 100+   | 40+   | Excellent   |
| 192/105   | 90   | 39  | Excellent   |
| 196/105   | 10-15  | 20-23   | Excellent   |
| 199/105   | 5-10   | 14-20   | Excellent   |
| 203/106   | 3-13   | 9-22  | Transceiver Battery Weak - Scratchy<br>But Satisfactory |
| 196/105   | 10-50  | 20-34   | Excellent   |
| 196/104   | 80   | 38  | Excellent   |
| 193/104   | 100+   | 40+   | Fresh Battery In Transceiver                            |
| 192/102   | 100+   | 40+   | Near Antenna At Shop                                    |
| 189/102   | 100+   | 40+   | Excellent   |
| 189/99  | 13-42  | 22-32   | Excellent   |
| 190/98  | 10-45  | 20-33   | Excellent   |
| 193/96  | 100+   | 40+   | Under Antenna   |
| 193/93  | 100+   | 40+   | Future Booster Location                                 |
| 193/92  | 20-80  | 20-38   | Excellent   |
| 193/91  | 5-16   | 14-24   | Excellent   |

| MINE<br>COORDINATES<br>OF TWO-WATT<br>TRANSMITTER | MEASURED<br>INPUT TO<br>RECEIVER<br>uV | SIGNAL MARGIN<br>ABOVE 20 dBq<br>(0.8 uV)<br>dB | COMMENTS                        |
|---|--|---|---------------------------------|
| 193/91  | 30-45                                  | 29-33   | At Face                         |
| 193/91  | 100                                    | 40  | Excellent                       |
| 196/94  | 2-16                                   | 12-24   | Excellent                       |
| 194/99  | 30-70                                  | 29-37   | Excellent                       |
| 200/94  | 100+                                   | 40  | Under Last Antenna              |
| 202/94  | 2-18                                   | 12-28   | Excellent                       |
| 205/91  | 2-10                                   | 12-20   | Slightly Noisy But Satisfactory |
| 202/93  | 2-5                                    | 12-14   | Noisy And Marginal              |
| 199/93  | 2-10                                   | 12-20   | Slightly Noisy Satisfactory     |
| 195/93  | 3-15                                   | 9-23  | Satisfactory                    |
| 199/99  | 20-80                                  | 26-38   | Excellent                       |
| 190/93  | 3-10                                   | 9-20  | Satisfactory                    |
| 190/94  | 4-15                                   | 12-23   | Excellent                       |
| Near Damaged Reflector                            |  |   |                                 |
| 188/93  | 2-10                                   | 6-20  | Satisfactory                    |
| 186/93  | 1-5                                    | 0-14  | Noisy Marginal                  |
| 185/93  | 1-5                                    | 0-14  | Noisy Marginal                  |
| At Face   |  |   |                                 |
| 187/94  | 10-28                                  | 20-24   | Excellent                       |
| 188/97  | 10-16                                  | 20-24   | Excellent                       |
| 188/99  | 20-80                                  | 26-38   | Excellent                       |
| 188/99  | 40-100+                                | 32-40   | Excellent                       |
| 188/100   | 35                                     | 31  | Excellent                       |
| 188/102   | 40-100                                 | 32-40   | Excellent                       |
| 184/102   | 20-60                                  | 26-35   | Excellent                       |
| 180/102   | 5-38                                   | 14-32   | Excellent                       |
| 180/101   | 2-10                                   | 6-20  | Slightly Noisy Satisfactory     |
| 180/100   | 2-10                                   | 6-20  | Slightly Noisy Satisfactory     |
| 180/102   | 34                                     | 31  | Excellent                       |
| 188/103   | 100+                                   | 40+   | Excellent                       |
| 188/105   | 100+                                   | 40+   | Excellent                       |
| 186/105   | 50-80                                  | 34-38   | Excellent                       |
| 183/105   | 15-40                                  | 23-32   | Excellent                       |
| 180/105   | 28                                     | 30  | Excellent                       |
| 180/105 Face                                      | 20                                     | 26  | Excellent                       |
| 180/106   | 5-10                                   | 14-20   | Satisfactory                    |
| 185/106   | 5-17                                   | 14-20   | Satisfactory                    |
| 188/107   | 12-55                                  | 21-35   | Excellent                       |
|   | 24-70                                  | 28-37   | Excellent                       |