

**A minerals research contract report
February 1981**



**Contract J0308024
University of Oklahoma**

**BUREAU OF MINES ★ UNITED STATES DEPARTMENT OF THE INTERIOR
Minerals Health and Safety Technology**

The views and conclusions contained in this document are those of the authors and should not be interpreted as necessarily representing the official policies or recommendations of the Interior Department's Bureau of Mines or of the U.S. Government.

REPORT DOCUMENTATION PAGE	1. REPORT NO. OU/EECS/81-1	2.	3. Recipient's Accession No. 81/1/USBM
4. Title and Subtitle Data Security for In-Mine Transmission Final Report - Part 1			5. Report Date February, 1981
7. Author(s) Jon G. Bredeson, Jeffery L. Kohler, Harvinder Singh			6.
9. Performing Organization Name and Address School of Electrical Engineering and Computer Science University of Oklahoma Norman, Oklahoma 73019			8. Performing Organization Rept. No. EECS 1-81
12. Sponsoring Organization Name and Address U.S. Bureau of Mines Pittsburg Mining and Safety Research Center 4800 Forbes Avenue, Pittsburg, PA 15213			10. Project/Task/Work Unit No.
15. Supplementary Notes Prepared in cooperation with Ketron, Inc., Wayne, PA 19087			11. Contract(C) or Grant(G) No. (C) J0308024 (G)
16. Abstract (Limit: 200 words) <p>A survey of electromagnetic noise reports was performed and a summary of the results are given. Industrial concerns were surveyed for techniques to minimize the effects of electromagnetic noise and are presented. The common types of communication links used in mines today are presented. A mathematical development was presented which determines the probability of bit errors versus distance for various types of communication links designed for in mine use. The probability of undetected errors for the protocols of the communication links is given together with burst error detection.</p>			13. Type of Report & Period Covered Final Part I 11/79 - 12/80
17. Document Analysis a. Descriptors Electromagnetic noise, mine communication links, coaxial cable noise, twisted pair noise, differential mode noise, common mode noise, data security, bit error rates, protocols, probability of undetected error, burst errors. b. Identifiers/Open-Ended Terms Mining Engineering, Electrical Engineering, Communication c. COSATI Field/Group Engineering			14.
18. Availability Statement Release Unlimited	19. Security Class (This Report) unclassified	21. No. of Pages 99	
	20. Security Class (This Page)	22. Price	

FOREWARD

This report was prepared by University of Oklahoma, Norman, OK, & Ketron, Inc., Wayne, PA under USBM Contract number JO308024. The contract was initiated under the Minerals Health and Safety Technology Program. It was administered under the technical direction of Pittsburgh Mining and Safety Research Center with Mr. Edward Fries acting as Technical Project Officer. Mr. Joseph Gilchrist was the contract administrator for the Bureau of Mines. This report is a summary of the work recently completed as part of this contract during the period November 1979 to December 1980. This report was submitted by the authors on February 1981.

TABLE OF CONTENTS

Section Number or Appendix	Page
EXECUTIVE SUMMARY OF FINAL REPORT.	i
1. INTRODUCTION	1
2. ELECTROMAGNETIC NOISE IN MINES	3
2.1. Introduction	3
2.2. Survey of Noise Measurements	3
2.3. Summary of Noise Measurements.	4
3. COMMUNICATIONS SYSTEMS IN INDUSTRIAL ENVIRONMENTS.	7
3.1. Introduction	7
3.2. Summary and Conclusions.	8
4. CHANNELS USED IN MINE COMMUNICATION SYSTEMS.	10
4.1. Introduction	10
4.2. Summary and Conclusions.	10
5. THEORETICAL DEVELOPMENT OF NOISE ON MINE COMMUNICATION TRANSMISSION LINES	14
5.1. Introduction	14
5.2. Twisted Pair Differential Mode Current	15
5.3. Twisted Pair Common Mode Current	18
5.4. Coaxial Cables	18
5.5. USBM Special Cable	21
5.6. Signal to Noise Ratio.	21
6. MINE CHANNEL ERROR PERFORMANCE	25
6.1. Introduction	25
6.2. Conspec Data Communication System.	25
6.3. West Virginia University MACCE Data Communication System	30

7.	DATA SECURITY	36
7.1.	Introduction.	36
7.2.	Conspec Data Communication System	37
7.3.	West Virginia MACCE Data Communication System	37
8.	DETECTION OF BURST ERRORS	46
8.1.	Introduction.	46
8.2.	Conspec Data Communication System	46
8.3.	West Virginia University MACCE Data Communication System	46
9.	CONCLUSIONS AND RECOMMENDATION.	47
A.	RESPONSE OF A TWISTED PAIR TO INCIDENT UNIFORM AND NONUNIFORM ELECTROMAGNETIC FIELDS	49
A.1.	Introduction.	49
A.2.	Line with Parallel Conductors Illuminated by a Nonuniform Field.	49
A.3.	Twisted Pair Illuminated by a Uniform Field	52
A.4.	Twisted Pair Illuminated by a Field Due to a Small Loop.	55
B.	NOISE IN SHIELDED CABLES EXCITED BY EXTERNAL ELECTROMAGNETIC FIELDS	59
B.1.	Introduction.	59
B.2.	Shielded Cable Illuminated by an Arbitrary Field	59
B.3.	Coaxial Cable Illuminated by a Uniform Field.	61
C.	CONVERSION OF THE COMMON MODE CURRENT INTO DIF- FERENTIAL MODE CURRENT	64
C.1.	Introduction.	64
C.2.	D.C. Analysis of an Unbalanced Transmission Line.	64
D.	COMMON MODE CURRENT IN A TRANSMISSION LINE HAVING ITS DISJOINT SEGMENTS ILLUMINATED BY UNCORRELATED UNIFORM FIELDS . . .	68
D.1.	Introduction.	68

D.2.	Derivation of the Equation.	68
E.	TYPES OF DIGITAL TRANSMISSION SYSTEMS	74
E.1.	Introduction.	74
E.2.	Baseband Transmission	75
E.3.	Digital Modulation Systems.	77
E.3.1.	Amplitude-Shift Keying (ASK).	77
E.3.2.	Frequency-Shift Keying (FSK).	78
E.3.3.	Phase Shift Keying.	79
F.	ERROR DETECTION TECHNIQUES.	82
F.1.	Introduction.	82
F.2.	Notation.	82
F.3.	Principles of Error Detection	83
F.4.	Error Calculations.	83
F.5.	Burst Error Detection	84
G.	DATA COMMUNICATION PROTOCOLS.	87
G.1.	Introduction.	87
G.2.	Digital Data Communication Message Protocol--DDCMP	87
G.3.	Synchronous Data Link Control--SDLC	90
G.4.	Other Protocols	93
H.	KEY WORDS . ,	94
	REFERENCES.	97

LIST OF FIGURES

Figure Number	Page
2.1. Electromagnetic Noise Extremes for all Mines Collins Report.	5
4.1. Common Types of Communication Systems.	13
5.1. Differential Mode Noise Power vs. Frequency, Mean Noise Power, Terminated in Characteristic Impedance 135 ohms.	16
5.2. Differential Mode Noise Power vs. Frequency, Maximum Noise Power, Terminated in Characteristic Impedance 135 ohms.	17
5.3. Common Mode Noise power Versus Frequency, Twisted Pair Characteristic Impedance 442 Ohms.	19
5.4. Noise Power in Load of Coaxial Cable vs. Frequency, LDF4-50 Andrew Corporation, Characteristic Impedance 50 ohms, shield grounded at receiving end	20
5.5. USBM Special Cable	22
5.6. Common Mode Power in Load vs. Frequency, USBM Special Cable, Shield Grounded on Receiving End	23
6.1. Probability of Error vs. Distance (Meters) Conspec Accessor Link with USBM Cable	28
6.2. Probability of Error vs. Distance (Meters) Conspec Long Distance Accessor Link	29
6.3. Probability of Error vs. Distance (Meters) for Mean Noise Power. West Virginia University MACCE Link Center Frequency 1170 Hz.	31
6.4. Probability of Error vs. Distance (Meters) for Mean Noise Power, West Virginia Univer- sity MACCE Link, Center Frequency 2125 Hz	32
6.5. Probability of Error vs. Distance (Meters) for Maximum Noise Power, West Virginia MACCE Link Center Frequency 1170 Hz	33
6.6. Probability of Error vs. Distance (Meters) for Maximum Noise Power, West Virginia University MACCE Link, Center Frequency 2125 Hz	34

7.1.	Probability of Undetected Error vs. Distance (Meters), Conspec Accessor Link with USBM Cable.	38
7.2.	Probability of Undetected Error vs. Distance (Meters), Conspec Long Distance Accessor Link	39
7.3.	Probability of Undetected Error vs. Distance (Meters) for Mean Noise Power, West Virginia University MACCE Link, Center Frequency 1170 Hz.	41
7.4.	Probability of Undetected Error vs. Distance (Meters) for Mean noise Power, West Virginia University MACCE Link, Center Frequency 2125 Hz.	42
7.5.	Probability of Undetected Error vs. Distance (Meters) for Maximum Noise Power, West Virginia University MACCE Link, Center Frequency 1170 Hz.	43
7.6.	Probability of Undetected Error vs. Distance (Meters) for Maximum Noise Power, West Virginia University MACCE Link, Center Frequency 2125 Hz.	44
A.1.	Parallel Conductor Line Illuminated by a Nonuniform Field.	50
A.2.	Parallel Conductor Line Illuminated by a Uniform Plane Wave	50
A.3.	Twisted Pair Illuminated by a Uniform Plane Wave.	54
A.4.	Twisted Pair Illuminated by a Field Due to a Small Current Loop	54
B.1.	Shielded Cable Geometry	60
C.1.	D.C. Analog Circuit of a Transmission Line.	65
C.2.	D.C. Analog Circuit of a Transmission Line After Δ -Y Transformation	65
D.1.	Wire over a Ground Plane.	69
D.2.	Transmission Line Having Its Disjoint Segments Illuminated by Uncorrelated Fields	72
E.1.	Block Diagram of a Digital Data System. (a) Transmitter (b) Receiver.	74
E.2.	System Model and Waveforms for Synchronous Baseband Digital Data Transmission. (a) Baseband Digital Data Transmission. (b) Typical Transmitted Sequence. (c) Received Sequence Plus Noise.	76

E.3.	Receiver Structure and Integrator Output. (a) Integrate-and-dump Receiver. (b) Output From Integrate-and-Dump Detector	77
E.4.	Modulation Techniques	80
G.1.	DDCMP Message Format.	88
G.2.	DDCMP Simple Handshaking Procedure (One Direction).	89
G.3.	SDLC Message Format	91
G.4.	SDLC Simple Handshaking Procedure (One Direction)	92

LIST OF TABLES

Table Number	Page
6.1. Characteristics of Mine Communication Links.	27
7.1. Approximate Maximum Distances in Meters for Usable Communication Links.	45
E.1. Probability of Error for Various Communication Systems	81
F.1. Some Common BCH Codes.	86

EXECUTIVE SUMMARY

of

FINAL REPORT - PART I

The electromagnetic noise that exists in a mining environment is quite severe and was shown to have been reasonably well documented by a number of researchers. The noise levels are such that prudent communication design requires the careful use of all the electromagnetic noise data available.

A comprehensive survey was undertaken to determine techniques used in various industrial environments to achieve secure communications in the presence of electromagnetic interference. The techniques are rudimentary, but have produced reasonably good results. A number of these techniques could be applied to the mining environment.

The survey of channels used in mine communication systems indicated that 16 and 18 gauge twisted pair wire is the most common type. A rugged plastic sheath and steel messenger cables are sometimes added to provide additional ruggedness. The trolley wire is also extensively used for voice communication. All data that is transmitted requires a very narrow bandwidth for present communication systems.

A comprehensive theoretical development of noise on mine communication transmission lines for various types of communication links is presented. The noise power at the outputs of the links is shown to be quite high for most cases. The noise power greatly affects the data rates on all of these links and should be used to evaluate the overall bit error rates.

Several communication systems intended for use in the mining environment are examined. The bit error rate as a function of distance was mathematically determined for these systems and plotted. The data communication protocol for these communication systems was examined and the probability of an undetected error versus distance was mathematically determined and plotted. The burst error detection capabilities are analyzed and presented.

Conclusions and recommendations are presented for different communication systems. Significant mathematical developments and background information is included in the appendices.

SECTION I

INTRODUCTION

Electromagnetic noise is always present in data transmission systems because noise enters the transmission medium. The transmission medium can be a pair of wires, a radio link, coaxial cable, or other types. The addition of noise into the data transmission channel greatly affects the data security and baud rate of the system. Electromagnetic noise also enters transmission mediums for in-mine data transmission systems. Any proposed data transmission system designed for in-mine applications must take into account the effects of electromagnetic noise before the problem of data security can be addressed.

The data communication systems for transmitting sensor, control and data information will certainly be expanded at a significant rate in the next several years as automation and remote sensing increases in the mining industry. The types of digital data communication channel requirements will necessarily be different for sensor, control, and data information. The main requirements for each type of channel will be a different baud rate, transmission distance, and bit error rate specification. It is anticipated that baud rates up to 40 kilobaud will be needed.

Although electrical noise is not a desired physical component of a data transmission system, its presence is real. It is not generally associated with the transmission mediums, through which it normally gains access to the system. During operation, the machinery used in mining creates a wide range of many types of intense electromagnetic interference and, therefore, ambient electromagnetic interference is a major concern when designing a secure data transmission system. With the projected increase of mining by remote control, and with the increased emergence of remote environmental and safety monitoring systems, there is a definite need to develop and provide secure data transmission hardware and procedures (or protocols) for in-mine systems. A number of studies done for the Bureau of Mines have been published which examined the electromagnetic noise environment in various types of mines. The electromagnetic fields were measured with several types of antennas in numerous locations throughout the mine, as a function of antenna orientation, time of day, and so on. Several studies also measured the noise currents and voltages on telephone wires and trolley phone wires in various mines.

The Final Report Part I presents results and findings which are separated into sections. The First Section is the introduction and the Second Section will consist of a comprehensive review of reports and papers dealing with electromagnetic noise in underground mines. Section Three will be a review of the techniques used in various industrial environments which combat electromagnetic interference, and an evaluation of implementing these techniques in the mining industry.

A survey of different types of communication transmission systems presently used in mines will be given in Section Four. A mathematical analysis of the mechanism that noise enters the transmission medium and plots of noise levels at the ends of communication links will be presented in Section Five.

The sixth Section uses mathematical models and analysis to determine the bit error rates of several communication links that are intended for the mine environment. The results are presented in series of plots of probability of error versus distance.

Section Seven presents a mathematical analysis to determine the probability of undetected error for the protocols that are used on the data systems presented in Section Six. A series of plots of probability of undetected error versus distance is given that correspond to plots in Section Six. Section Eight analytically determines the ability of the protocols to detect burst errors. Section Nine presents conclusions and recommendations for future work.

The appendices present supporting material that is used in the rest of the report. This information supplements and gives background on common practices and systems which are used in the data communication field.

SECTION 2

ELECTROMAGNETIC NOISE IN MINES

2.1. Introduction

Several studies done for the Bureau of Mines have been published which examined the electromagnetic noise environment in mines. The electromagnetic fields were measured with several types of antennas in numerous locations throughout the mine, as a function of antenna orientation, time of day, and so on. This noise will be induced into mine communication channels from the electromagnetic environment and will affect the baud rate and bit error rate of the communication link. A knowledge of the noise-voltage characteristics that exist on mine channels is needed to intelligently design a communication system.

2.2. Survey of Noise Measurements

A number of reports and papers have been published concerning electromagnetic noise in underground mines. Kanda, Bensema, and Adams have obtained considerable data on electromagnetic noise in coal, metal, and non-metal mines [1,2,3,4,5]. A portion of this data was also published and summarized by Kanda [6]. The time and amplitude statistics illustrated by Kanda are important and useful in describing the time-dependent, measured electromagnetic noise in mines. They are: 1) Allan variance analyses, 2) interpulse spacing distributions, 3) pulse duration distributions, 4) average crossing rates, and 5) amplitude probability distribution. The curves Kanda gives should characterize the noise environment in the mines from which the data was taken and will help in the design of reliable communication systems.

Crary determined that the surface electromagnetic noise can probably be best characterized by its sources [7]. These are as follows:

1. 60 Hz powerline noise and its harmonics. This also includes a noise generated on the powerlines by any electrical equipment which may be attached thereto.
2. Atmospheric noise. The source of this is the distribution of thunderstorms over the entire globe at the time in question. Signals propagate so well in general at VLF that all noise sources will usually contribute significantly to the atmospheric noise at any surface location, with the possible exception of times when an intense local storm is in progress.
3. VLF-LF transmitters. Their stations operate in the range of 10 to 40 KHz. They may be significant contributors to the noise involved, depending upon the operating frequency and location.
4. "Whistlers and VLF emissions." This group of sources relate to solar-geophysical disturbances, dependent upon magnetic latitude and the amount of disturbance present. The sources

of some are known to be atmospheric streams of incoming solar particles, while others are still unknown.

Crary found the situation below the surface is significantly different. The signals from atmospheric noise, VLF transmitters, and other noise signals which are important on the surface are attenuated rapidly by the earth, so that only in very shallow mine workings will these noise sources be significant. The greatest source of subsurface noise comes from the ac power supplied to the mine, and the dc or other power developed from it. This dc is used to power various types of mining equipment including shuttle cars and haulage vehicles [7]. Some mines use only dc power.

Crary's investigation measured broadband, narrowband, split-band, and sweep frequency noise. The frequency range examined was in the 20 to 100 KHz range for most of the measurements and the equipment was used with several different types of antennas including a loop and monopole. The results were given referenced to microvolts per meter and microamps per meter for different antennas, measurement techniques, time of day, month, location of antenna, etc.

Aldridge gives information on noise levels for horizontal-vertical magnetic axis receiving loops as a function of frequency from 10 to 100 KHz normalized to per cycle of bandwidth [8]. Westinghouse has made surface and subsurface noise measurements as a function of frequency [9]. Other reports exist detailing electromagnetic noise characteristics for mine situations [10,11].

Cory has measured electromagnetic noise on twisted pair telephone lines in two different coal mines [12]. The lines were measured for both common mode and differential mode noise currents in various locations in a "quiet" and "noisy" mine. The noise levels were high and the differential mode noise was sometimes more than common mode noise which is usually not the case. Cory observed that unbalances in the supposedly balanced twisted pair converted a lot of the common noise current into differential mode noise current.

2.3. Summary of Noise Measurements

The amount of electromagnetic noise whether it is noise current, noise voltage, noise magnetic or electric field intensity varies considerably with time of day, location in mine, types of equipment operating, and also from mine to mine. The noise which would enter a twisted pair will obviously exhibit the same types of variations and to give plots for all these variable situations for the different levels of noise would be difficult and not too illuminating. A much more reasonable way to proceed which will provide much more general results when applied to different mines would be to have a representation of noise for the mean (average) and maximum noise cases. Collins Radio Company has summarized and plotted electromagnetic noise for the studies conducted by a team from NBS/ITS [13]. This information is plotted in Figure 2-1 and the mean noise was determined to be approximated by

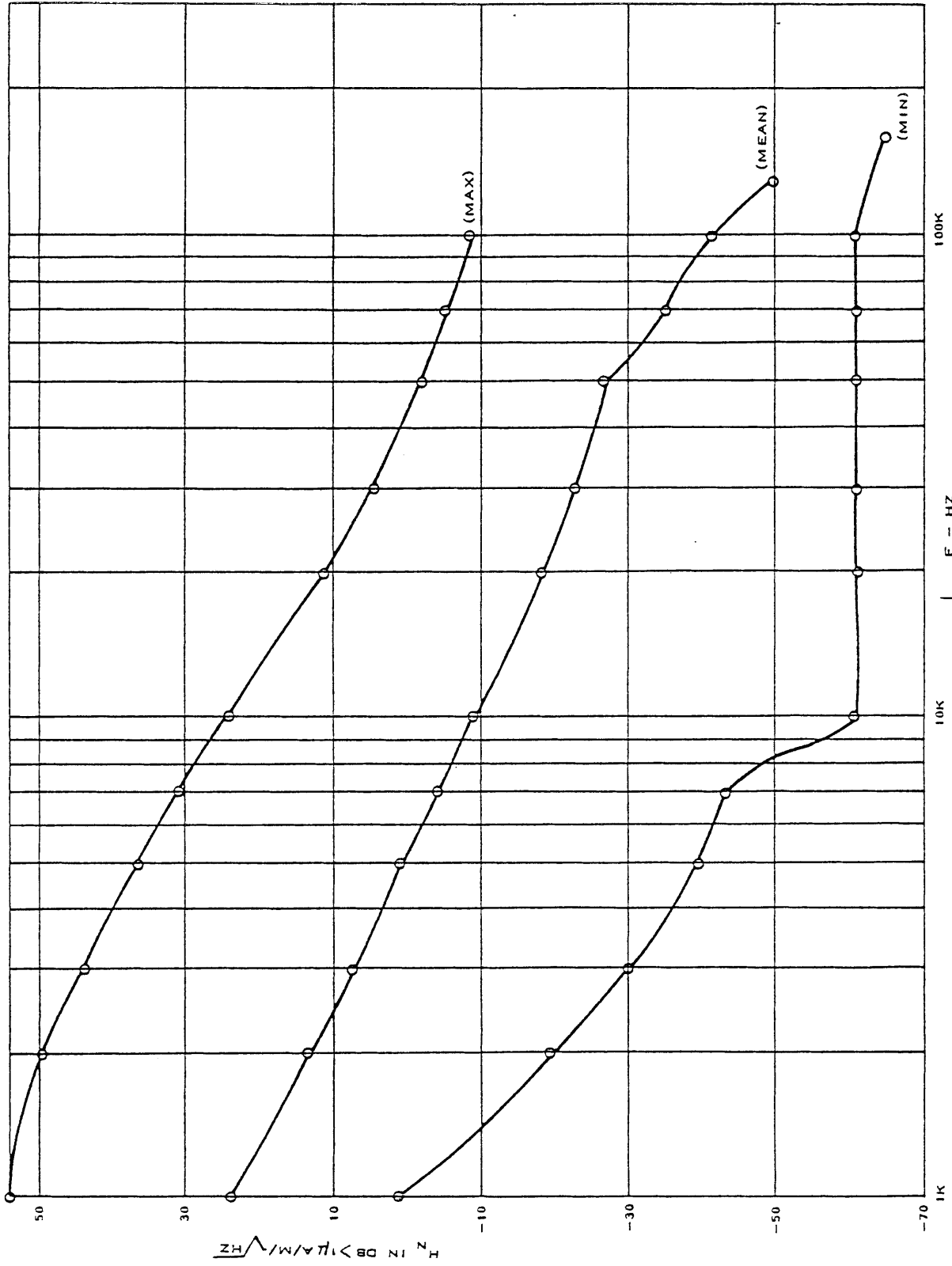

Figure 2.1. Electromagnetic Noise Extremes for all Mines

Collins Report, NTIS PB-244897

$$H_N = 121.5 - 32.5 \log_{10} f(\text{Hz}) \quad \text{mean (average)}$$

the maximum noise can be approximated by

$$H_N = 159.23 - 33.95 \log_{10} f(\text{Hz}) \quad \text{maximum}$$

where

$$H_N \text{ is in dB } > 1\mu\text{A/meter}/\sqrt{\text{Hz}}$$

A number of other noise measurements have been made by the other researchers with less comprehensive data, but which still fits quite well the average results of Kanda, Bensema and Adams. Therefore, it is felt that mean and maximum noise in mine environments can be accurately modeled by the previous equation for all types of in-mine communication systems. These two equations will be exclusively used for obtaining noise characteristics at the outputs of the different types of communication channels in the following sections.

SECTION 3

COMMUNICATIONS SYSTEMS IN INDUSTRIAL ENVIRONMENTS

3.1. Introduction

The techniques used in various industrial environments to achieve secure communications in the presence of electromagnetic interference (EMI) were examined to determine their applicability for use in the mining industry. The review consisted of a brief literature search and extensive meetings with technical representatives of various industries. The following types of industries were included in this study:

- o Petroleum
- o Textile
- o Glass
- o Manufacturing
- o Paper and Pulp
- o Chemical
- o Automotive
- o Steel
- o Electric Utility

During the meetings, the following general information was discussed:

- o The type of communication system used by the different industries.
- o General specifications of the hardware used to implement the communications system.
- o The physical extent and size of each system.
- o General performance parameters.
- o Research activities performed in support of a new product or client who is experiencing EMI difficulties with a given product.

The following specific information was requested concerning the channels used by the communications system:

- o Channel type
- o Bandwidth required by application and bandwidth of channel
- o Tolerable error rate
- o Sources of in-plant EMI
- o Any data on the characteristics of in-plant EMI
- o Type of protocol used

- o Type of error detecting and correcting codes and hardware used

- o Specifications of channel (as appropriate for wired and wireless links)

The technical representative of seven (7) different industries were contacted. Among these individuals, information concerning communications systems in over thirty different plants were obtained. In addition, manufacturers of data communications systems were contacted. However, it was impossible to obtain meaningful information from this group due to their concern about the proprietary nature of the requested information. The information obtained is summarized in the balance of this section.

3.2. Summary and Conclusions

All of the communications systems examined were used for process measurement and/or control. These systems have a common denominator in their simplicity. It seems that in all cases the emphasis of the systems design was on the simple, low cost, and reliable techniques. Almost all of the systems in use were analog and utilized a four to twenty milliamp current loop interface. This type of interface was the extent of error detection used by these systems. Applications of digital coding or error correcting methods were rarely encountered and always consisted of digital parity methods to detect errors and initiate retransmission. In cases where extraordinary reliability is required, the most prevalent technique is to use redundant transducers and data highways. Redundance of data highways is achieved by using multiple cables or by sending the signal several times over the same cable.

The industry standard channel for data transmission is shielded, multi-conductor, twisted-pair cable. In many cases, shielded cables are used to eliminate all EMI problems. When questioned on the sources and severity of in-plant EMI, it was found that no one had an understanding of this issue. It seemed that in all cases, twisted pair was used and if a problem was found to exist, the unshielded cable was replaced with a shielded one. Because this philosophy has been working so well, there has been no need to gather additional information on EMI, or to resort to a more sophisticated signaling technique. The size of the twisted-pair cable is generally determined by supplier availability rather than any technical considerations. The only deviation from the use of multi-conductor shielded twisted pair occurred in electric powered generation plants. There, because of a combination of low-level signals and high background-noise, it is necessary to use a cable where each twisted pair is shielded and then the entire bundle of cable contains a separate shield. This was found adequate for the application. Again, this solution resulted from trial and error, rather than an engineering analysis of the problem.

Based on the information obtained in this study, it can be concluded that industrial communications system practice for reliability transmitting and receiving information in noisy environments is of minimal utility to the mining industry. In fact, it is quite surprising to have found that the mining industry is really more advanced when it comes to a specific knowledge of electromagnetic interference sources and problems in their environment.

Unfortunately, the industrial solution, i.e., shielded twisted pair whenever an EMI problem is suspected, is not always practical in the mining industry for two reasons. First, the extensive lengths of cable required to mining would sometimes prohibit the use of the more expensive shielded, twisted-pair, multi-conductor cables. Secondly, the maintenance of these cables in the harsh mining environment could prove to be difficult. It is encouraging, however, to find that secure communications can be implemented in industrial environments simply by using shielded cable pairs. It is reasonable to assume that manufacturers could supply shielded cables with jacket specially made to withstand the mining environment, much as special power cables have been developed specifically for mining.

SECTION 4

CHANNELS USED IN MINE COMMUNICATION SYSTEMS

4.1. Introduction

The purpose of this section was to identify the types of channels being used in mine communications systems and to determine the relative performance of these channels. During the course of this investigation, technical personnel representing every major coal company in the United States was contacted. The results presented here represent practices in over fifty deep coal-mines.

4.2. Summary and Conclusions

Present day communications systems in coal mines consist primarily of trolley phones and pager phones. The trolley phone signal is typically frequency modulated with carrier frequencies ranging from 60 kHz to 190 kHz. The transmission medium is the trolley line and mine track. The trolley line is a very convenient mode of voice communication because it not only provides a transmission medium but it also supplies power to the transceiver. The typical transceiver is designed to place a 25 watt radio frequency signal onto a 20 ohm line, and has a receiver sensitivity of 200 microvolts. On a well maintained system, it is possible to have intelligible communications over distances of several miles.

The main disadvantage of using the trolley line as a communications channel is that it is inherently noisy. Sources of noise include rectifier harmonics, motor commutation noise, transients from DC contactor opening or closing, sparking and arcing resulting from the motion of the trolley pole contact shoe on the trolley line, and arcing faults on the DC system. The trolley line is also subject to varying impedance resulting from mobile loads (jeeps, locomotives, and so forth), movement of pumps, and other DC loads which may be placed anywhere along the trolley line. Yet the trolley line still remains as the most common mode of voice communication in American coal mines.

The pager phone is interconnected using two conductor cables. The cable type used most frequently consist of two single conductors, PCV insulated, number 16 and 18 solid copper wires, which are twisted together.

Pager phones, which are typically powered by a pair of 12-volt dry cells, utilize base-band transmission and are capable of placing a one-or-two-watt signal onto a 200 ohm line. Since each phone represents a 4500 ohm load at 1 kHz, many phones can be placed on one line. Paging is accomplished when the initiating phone impresses a 12 or 24 volt DC bias on the line, which activates a speaker amplifier in the other phones. Once communication has been established, conversation is continued using regular telephone handsets with a push-to-talk button. A well maintained system can contain up to twenty phones and several miles of cable.

The phone line is inherently less noisy than the trolley line. However, the two lines typically are located in the same entry so that there is some interaction between the two. For example, the principle harmonic on the trolley line (360 Hz) can usually be heard and detected on the phone line.

The biggest problem with using the phone line for data transmission is the condition in which the line is generally maintained. Splices can be found at frequent intervals and a "good" splice generally consists of twisting the two conductors together with pliers and then applying friction tape. After a few weeks the splices become wet, the copper corrodes, and the lines short together, or to ground, or become open to various degrees.

In an attempt to improve the quality of the telephone line (twisted pair), some mines are using a number 26 or number 28 solid copper, PVC insulated, twisted pair which is enclosed inside a rugged plastic sheath. The sheath also contains a steel messenger cable. The transmission capability of the line is equivalent to that previously mentioned, and the line is much more rugged, thereby reducing the number of splices and other cable damage resulting from abuse, roof falls, and so forth.

Some mines have improved the quality of their transmission by utilizing a combination of the two different phone lines. The more expensive steel messenger line cable is used wherever the installation will be permanent, and the other line is used in the working sections where the line is frequently being extended and reduced in length.

The pager phone and the trolley phone account for approximately 98% of all communications system devices in use to date. The pager phone is frequently used to meet the statutory requirement which requires two-way voice communication up to each working section. The remaining 2% of communications systems found in deep coal mines consist of experimental devices and monitoring system and remote control systems.

Typically, the monitoring system include belt monitoring devices for fire, slippage, synchronization, and status. A few mines also sense the status of circuit breakers and fan parameters. Typically, the twisted pair cable, utilized for pager phone communications, is also utilized for the telemetered data from remote fans, pumps, and circuit breakers. The requirements of these signals are minimal due to the small bandwidth and low data rate. Manufacturers installing such monitoring systems have found the maximum single frequency on the pager phone line is 7 kHz (typically frequency shift keying is used). In a few mines shielded twisted pair can be found, and then a 25 kHz signal can be reliably impressed on the line.

Remote control systems, for non-experimental purposes, are rarely found in American coal mines. The only application of remote control technology to gain acceptance is remote control of continuous mining machines. Both wired, through an umbilical cord, and wireless channels are used. The umbilical systems utilize a digital asynchronous serial format of rates up to 2000 baud. Generally, multiplexing schemes are used to send and receive the data on one twisted pair of wires. Relatively simple parity checking methods, and signal repetition are employed to increase the data security. The wireless systems are similar, except that the digital signal is modulated and transferred at a frequency near 450 MHz.

The greatest problem existing with communication channels in mining applications appears to be daily maintenance. The combination of the harsh environment along with the lack of knowledge of the miners concerning the importance of maintaining channel integrity results in cables which are

frequently spliced. Errors in data transmission and poor voice quality transmissions are always attributed to a faulty channel. When the channel is properly repaired the quality of the voice communication is improved and data can be transmitted without error. It should also be noted that the existing communication systems in mines do not demand highly secure channels.

System Type	Channel Type	Channel Char.	*Usage	Comments	Frequency and Modulation	Information
1. Pager Phone	Twisted Pair	16-18 Gauge	1	Industry Standard	0-3kHz Baseband	Voice
2. Page Phone	Twisted Pair	26-28 Gauge	2	Tougher Cable	0-3kHz Baseband	Voice
3. Trolley Phone	Trolley Line and Rails	Noisy	1	Industry	60kHz-k90kHz FM	Voice
4. Belt Status Indicator	Non-dedicated Twisted Pair	See "1" and "2" Above	3	Requires Good Cable Maintenance	200Hz Asynchronous Baseband	Digital Status
5. Belt Status Indicator	Non-dedicated Twisted Pair	See "1" and "2" Above	3	Requires Good Cable Maintenance	400kHz FM	Digital Status
6. Belt Status Indicator	Dedicated Twisted Pair	See "1" and "2" Above	3	Not Affected by Changes in Voice	7kHz FSK	Digital Status
7. One-Way Paging Into	Wireless	Roof Bolts Used for Antenna	4	Used to Page People Who Aren't Near A Phone	88kHz	Voice
8. Communication Along	Wireless		3	Portable Transceivers "Walkie-Talkie"	256kHz	Voice
9. Telephone	Coaxial Cable		3	Expensive Cable, Slices Require Special Tools	290 FDM Channels 5.75mhz to 11.75mhz	Voice, Monitoring and Control
10. Remote Control of Machines	Wire (Twisted Pair Prior) Wireless	In Umbilical Cord 450 mhz	3		2000 Baud ----- 450 MHz	Digital Control and Status
11. Communications Along	Combination of Wire and Wireless	Radiax Cable (Slotted Coaxial)	4	Wireless Transceivers Coupled by Radiax Cable	450 MHz	Voice

Figure 4.1. Common Types of Communication Systems

*Usage Code

- 1 > 90%
- 2 75%
- 3 < 5%
- 4 Research Only

SECTION 5

THEORETICAL DEVELOPMENT OF NOISE ON MINE COMMUNICATION TRANSMISSION LINES

5.1. Introduction

The electromagnetic noise that exists in a mine will induce a noise voltage or current on a transmission line placed in the mine. The amount of noise is a function of the type of transmission line, terminating impedances, electromagnetic field and other factors which are hard to quantify. A number of formulas to calculate the noise current and voltages induced on a transmission cable from external fields can be found in available literature [16-20]. However, the important case of twisted wire pairs does not seem to be covered in the current literature. A derivation of the twisted pair case is given in Appendix A with various types of fields.

The equations for the transmission lines require the electromagnetic noise be represented by an electric field intensity (E field) instead of magnetic field intensity (H field). The electromagnetic noise surveys, however, have preferred to represent the noise as a magnetic field intensity. The only reasonable way to convert from an H field to an E field is to assume the electromagnetic field is a planar wave in free space [21]. The equation relating the E field and H field for a planar wave is

$$E = 377 H$$

with the E field perpendicular to the H field. Therefore, the electric field intensity for mean noise and maximum noise cases will be modified by

$$E(\text{dB}) = 20 \log 377 + H(\text{dB}).$$

The resultant E fields for electromagnetic noise for the mean and maximum cases are

$$E(\text{dB}) = 173.03 - 32.5 \log_{10} f \quad \text{Mean (Average)}$$

$$E(\text{dB}) = 210.76 - 33.95 \log_{10} f \quad \text{Maximum}$$

respectively and are in dB/ μ volt/meter/ $\sqrt{\text{Hz}}$.

The electric field intensity will be assumed to be the same in any direction even though noise surveys indicate that the H fields are a function of antenna orientation. The rationale for this assumption is that the noise fields were measured at certain times and in certain mines and the noise will vary. The information from this report will hopefully aid in the design of data communication systems in mines and most communication systems must be designed for average and worst case noise environments. Therefore using average and maximum noise field values for all orientations will provide meaningful results when the transmission lines have arbitrary orientations.

The most fundamental quantity to use for noise in communication systems is power because signal to noise ratios are power ratios. The noise power

will be represented in dB's in relation to 1 milliwatt which are abbreviated as dBm's. The dBm's will be with respect to load or characteristic impedances as is appropriate.

5.2. Twisted Pair Differential Mode Current

The twisted pair transmission line is used normally in a differential current mode where any common mode voltage induced equally on both wires will be eliminated by the differential input at the receiver. However, the voltage induced along any section of the pair will not necessarily be the same for each wire because of phase and magnitude differences of the illuminating electrical field. This difference will produce a differential current which flows in the terminating impedance at the receiver and will corrupt the incoming signal. The portion of the induced voltage which is common to both wires will produce a common mode current which can be much higher than the differential mode current.

Smith has examined the case of a wire pair with no twist embedded in an electric field and calculated the differential current flowing in a load resistor for both plane waves and nonuniform fields which are represented by a loop or dipole [19]. The twist in a wire pair produces a cancelling of the effect on the differential current because the differences of the induced voltages on each wire will have the opposite sign one pitch length down the wire. Unfortunately, no analysis was found for this important case in an extensive literature search. An equation was developed for the twisted pair and is given in Appendix A. The equation is difficult to integrate and must be integrated using numerical integration.

The most important part of any of these equations is the magnitude because this relates to noise power. The differential noise power in dBm is plotted for an 18 gauge twisted pair assuming a plane wave excitation in Figure 5.1., assuming a mean noise field. The differential noise power in dBm is also plotted for 18 gauge without a twist for a formula developed by Smith and given in Appendix A. The improvement from no twist to a line with a twist amounts to 80-90 dB difference. This is an excellent reason for twisting the wire. The noise power in the load is plotted for the same case in Figure 5.2, but the maximum noise field is used in this case. The oscillations in the curves at higher frequencies occurs because the wavelength is close to the length of the cable.

The actual electromagnetic noise field that exists in a mine will obviously not be a plane wave over the entire length of the communication link. A much better approximation would be to represent the electromagnetic noise by a nonuniform field similar to a field generated by a loop antenna. This would more closely approximate fields generated by electric machines in a mine. Smith developed formulas for the current at the end of a pair of wires with no twist in the vicinity of a loop [19]. A development is given in Appendix A which calculates the current at the end of a twisted pair in the vicinity of a loop. The communication link of 1000 meters would in all probability pass by a number of sources which generate nonuniform fields. Therefore, to make a more reasonable comparison to the plane wave, the number of loops along a wire was calculated to give an average field strength approximately the same as for the plane wave.

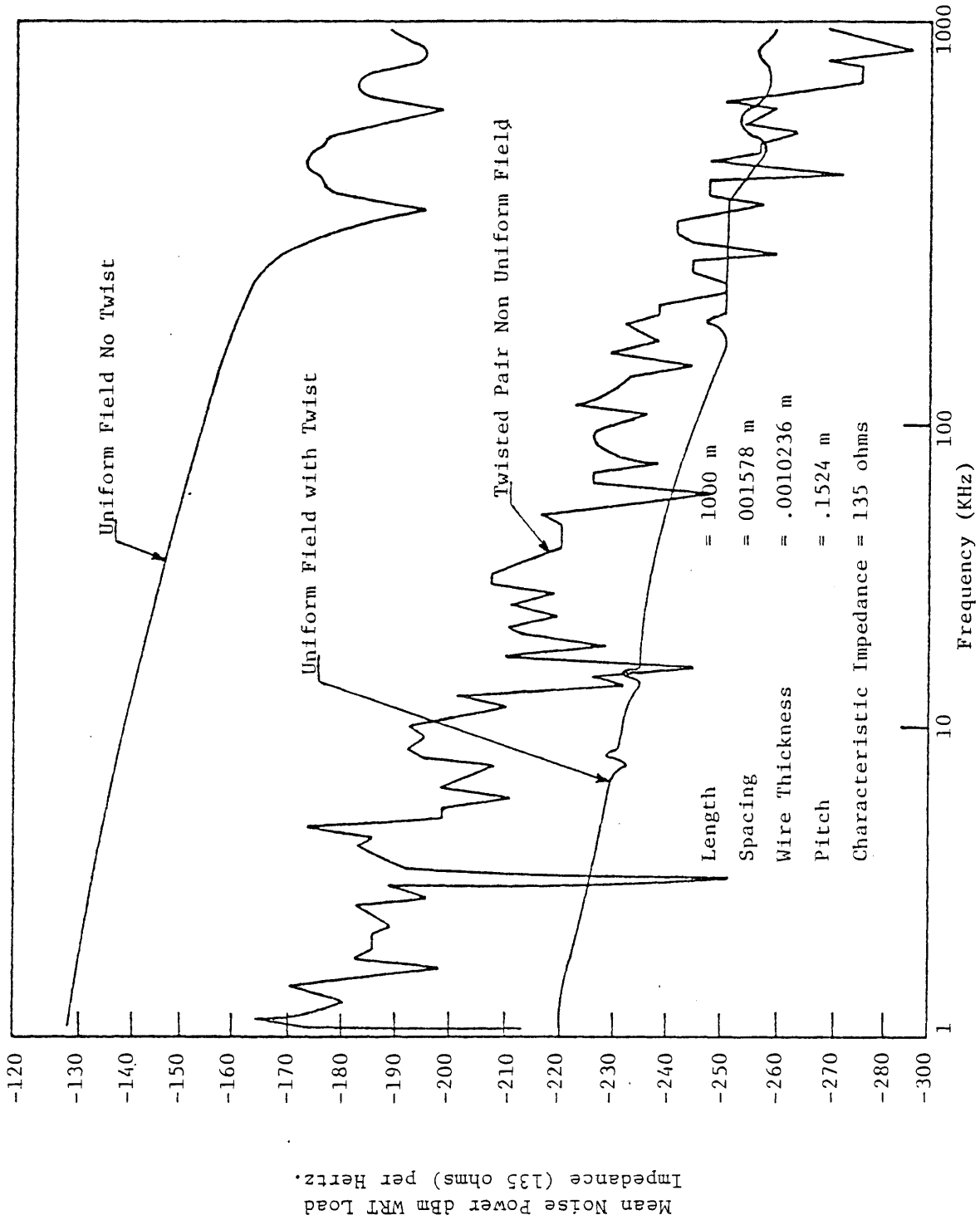

Figure 5.1. Differential Mode Noise Power vs Frequency, Mean Noise Power Terminated in Characteristic Impedance 135 Ohms.

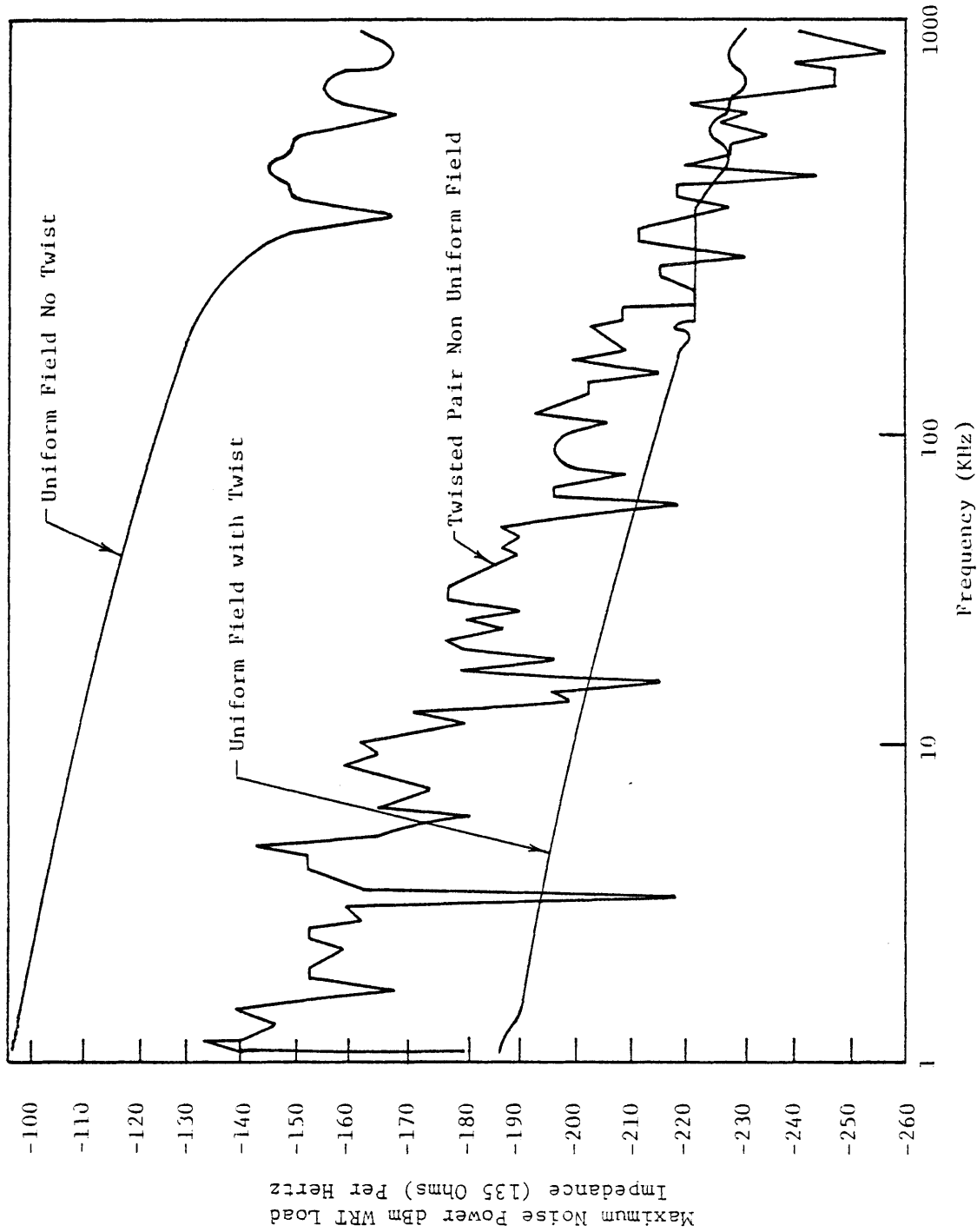

Figure 5.2. Differential Mode Noise Power vs Frequency, Maximum Noise Power, Terminated in Characteristic Impedance 135 Ohms.

The differential noise power in dBm is also plotted for 18 gauge in the presence of a nonuniform field in Figure 5.1 and 5.2 for the mean and maximum noise field, respectively. The noise power curve for these cases is not as smooth as the plane wave cases, however, the noise power for the uniform and nonuniform field with a twisted pair is similar. This occurs when the length of the pitch is significantly less than a wavelength which is usually the case for the frequencies where twisted pair is used. The noise power at the output of a twisted pair is more a function of the field strength than if the field is uniform or nonuniform.

5.3. Twisted Pair Common Mode Current

Any common mode current which flows in a bundle of wires is assumed to be divided equally between all wires in the bundle [19]. The common mode current in a twisted pair, therefore, should divide equally and 1/2 the total common mode current flows in each wire. Cory indicated in his report that due to "imbalances" in supposedly "balanced" transmission links will cause the amount of common mode current in each wire to be different and thus effectively produce a differential mode current much higher than anticipated [12]. Therefore, the amount of common mode current should also be calculated for the twisted pair used in Figure 5.1 and 5.2 under the same conditions. The equation for common mode current along a wire bundle is given in Appendix B. The plot of common mode current for the same 18 gauge twisted pair as in Figure 5.1 is given in Figure 5.3. Appendix C has an analysis for a simple case when a common mode current will not divide equally between both wires in the pair. An "imbalance" of one percent could then cause a differential mode power of 20 dB less than the common mode noise power [12]. Therefore, from Figure 5.3 for the mean noise case at 1 KHz the common mode noise power is about -15 dBm. 20 dB less would give -35 dBm differential noise power which is far higher than -131 dBm with no twist or -233 dBm with a twist mean differential noise power at 1 KHz given in Figure 5.1. This example clearly indicates that considerable care should be taken to insure a twisted pair be closely balanced.

5.4. Coaxial Cables

Vance [20] and Smith [19] have shown the illumination of a shielded cable by an external electromagnetic field excites a current distribution on the outer shield. Since the shield is not a perfect conductor, this current penetrates the shield and produces a voltage distribution along the inside length of the cable. This voltage produces a current in the interior load impedances. The most effective shield is solid with no holes and of high conductivity. The shielding effectiveness for a solid shield increases dramatically when the shield thickness is greater than one skin depth [20]. The geometry of a shielded cable is given in Appendix B along with appropriate equations.

A shielded cable that has been used in a mine is a 50 ohm, solid copper shielded cable made by Andrew Manufacturing. A plot of the power in the load for this cable is given in Figure 5.4. The noise power can be seen to drop off rapidly with an increase in frequency when the shield becomes greater than one skin depth (occurs at $f = 68$ KHz). In a cable with a braided shield, noise power would not drop off as rapidly due to magnetic and capacitive coupling through holes in the braided shield. Figure 5.4 shows that this coaxial cable is a much better communication link when used above 1 MHz.

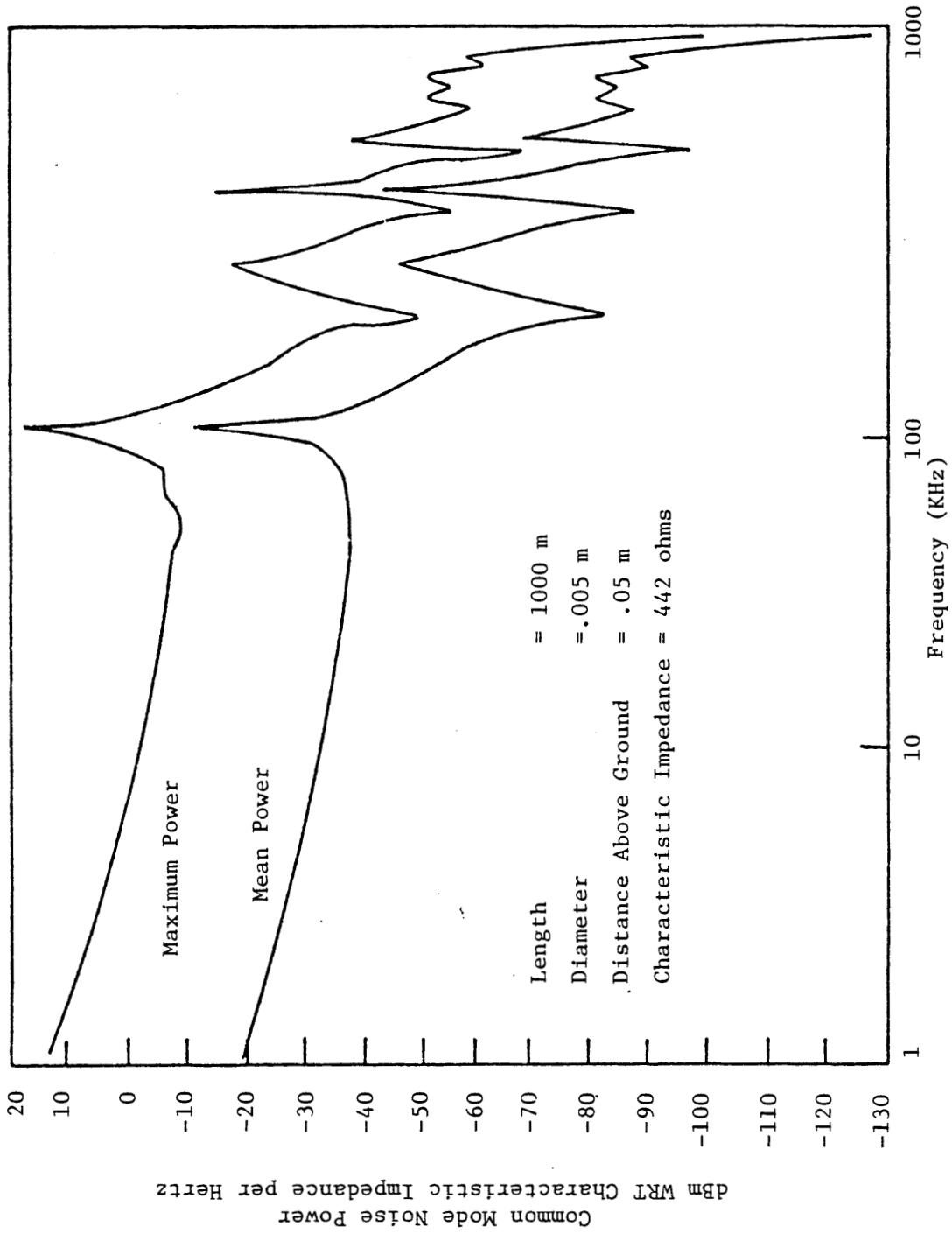

Figure 5.3. Common Mode Noise Power vs Frequency, Twisted Pair
Characteristic Impedance 442 Ohms.

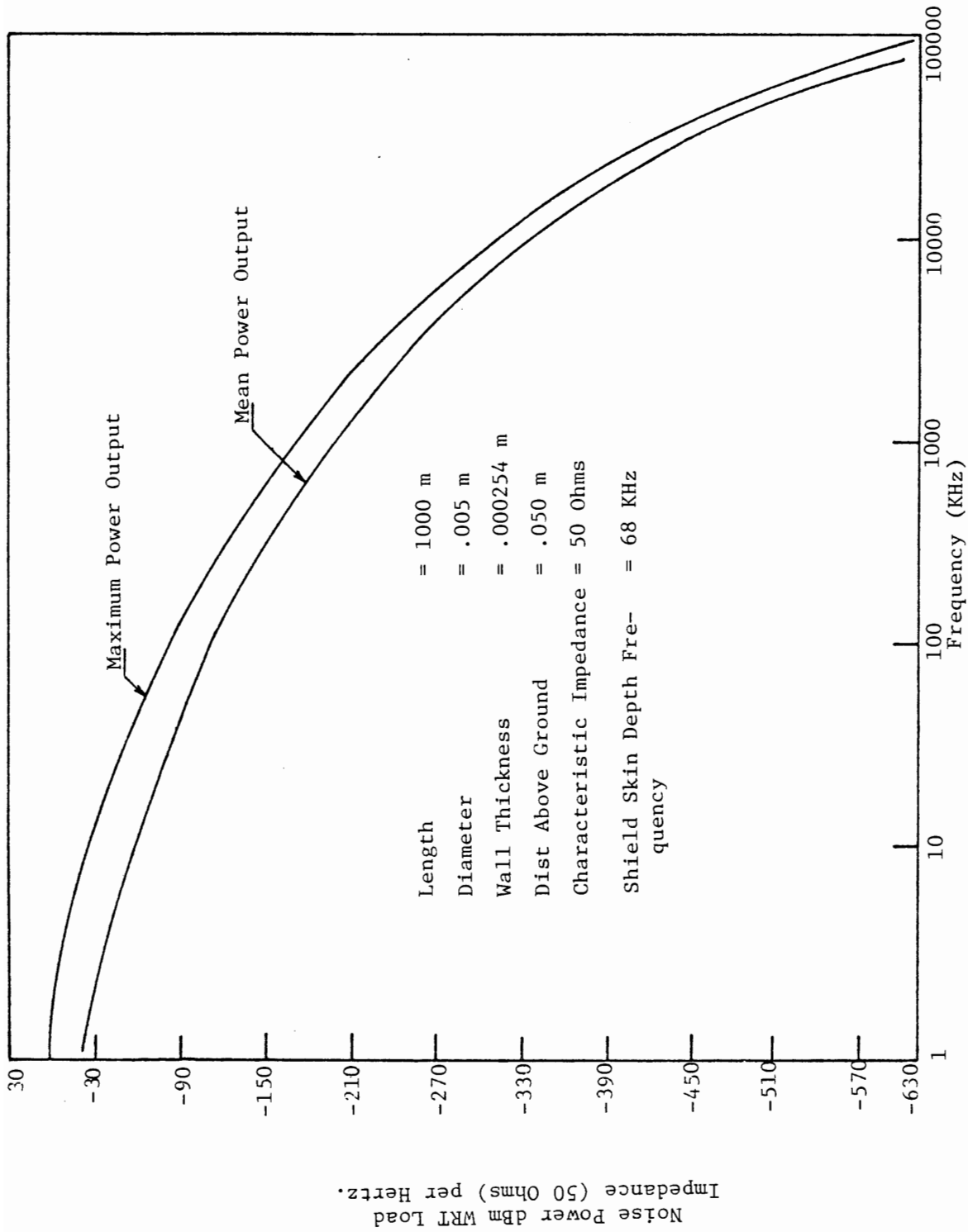

Figure 5.4. Noise Power in Load of Shielded Co-axial Cable vs Frequency, LDF4-50 Andrew Corporation Terminated in Characteristic Impedance 50 Ohms, Shield Grounded at Receiving End.

5.5. USBM Special Cable

The USBM has contracted to have a special cable built which will carry power and signals within the same cables. This cable is illustrated in Figure 5.5, and has metallized foil shield around each signal conductor plus a metallized foil shield around all conductors in the cable. The current flowing in each signal conductor can be found by using a similar equation for a single shielded cable with one conductor and by modifying the transfer function. The transfer function at the lower frequencies for which this cable is to be used is approximately a parallel combination of the DC resistance of the two shields with respect to unit length [20].

The induced differential current in the two signal conductors will be zero because of the surrounding shields. Any differential current which flows will be the results of "imbalances" in the transmission line. The common mode power in the load resistor when properly terminated is given in Figure 5.6 for this cable. The differential mode current caused by "imbalances" in the cable may produce a differential mode which is 20-30 dB less than the common mode noise power. Again, care should be taken to insure the line is as balanced as possible, when it is used in the differential transmission mode.

5.6. Signal to Noise Ratio

The most important parameter to represent the quality of a communication channel is the signal to noise ratio at the input to the receiver [22,23]. Other parameters that play a significant role will be examined in more depth later. The noise power in dBm at the output of the transmission lines were calculated for several types of communication links that are used in mine environments. The signal to noise ratio in dB's is equal to the signal power at the output in dBm's minus the noise power in dBm's at the output. The signal power at the output is equal to the signal power at the input less the loss in the transmission link. The noise power at the output in the plots are in dBm per Hertz, therefore, to obtain the noise power assuming a bandwidth of 1000 Hz would require the addition of 30 dB. The attenuation of the twisted pair 18 gauge wire is approximately 2 dB per mile.

A sample calculation for a 1000 meter twisted pair 18 gauge wire to obtain a 20 dB signal to noise ratio at the output is as follows:

Noise power at output at $f = 1$ KHz (Figure 5.2 Maximum Noise Uniform Field with Twist)	-185 dBm per Hz
Increase due to 1000 Hz bandwidth	30 dB
Total Noise Power	-155 dBm
Signal Output Power for 20 dB S/N	-135 dBm
Transmission loss (1000 meters at 10 KHz)	1.25 dB
Signal input power	-133.75 dBm

Similar calculations can be carried out for the other communication cables. A signal to noise ratio (with no other link impairments) of 20 dB gives a reasonably good quality digital communication link. However, the necessary S/N ratio is a function of the modulation and demodulation technique used. A

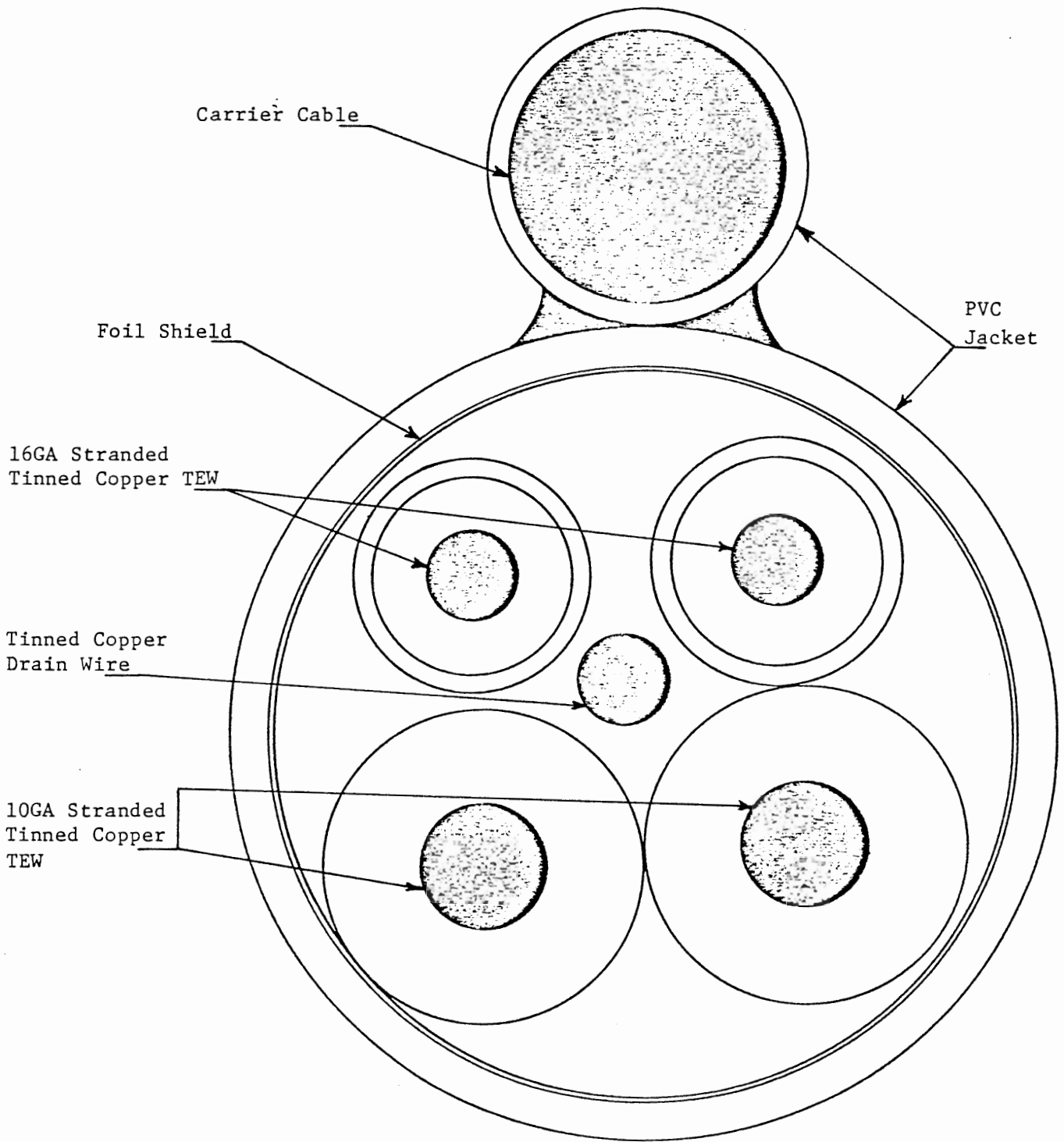

Figure 5.5. USBM Special Cable.

Common Mode Power dBm WRT Load
Impedance (50 Ohms) Per Hertz.

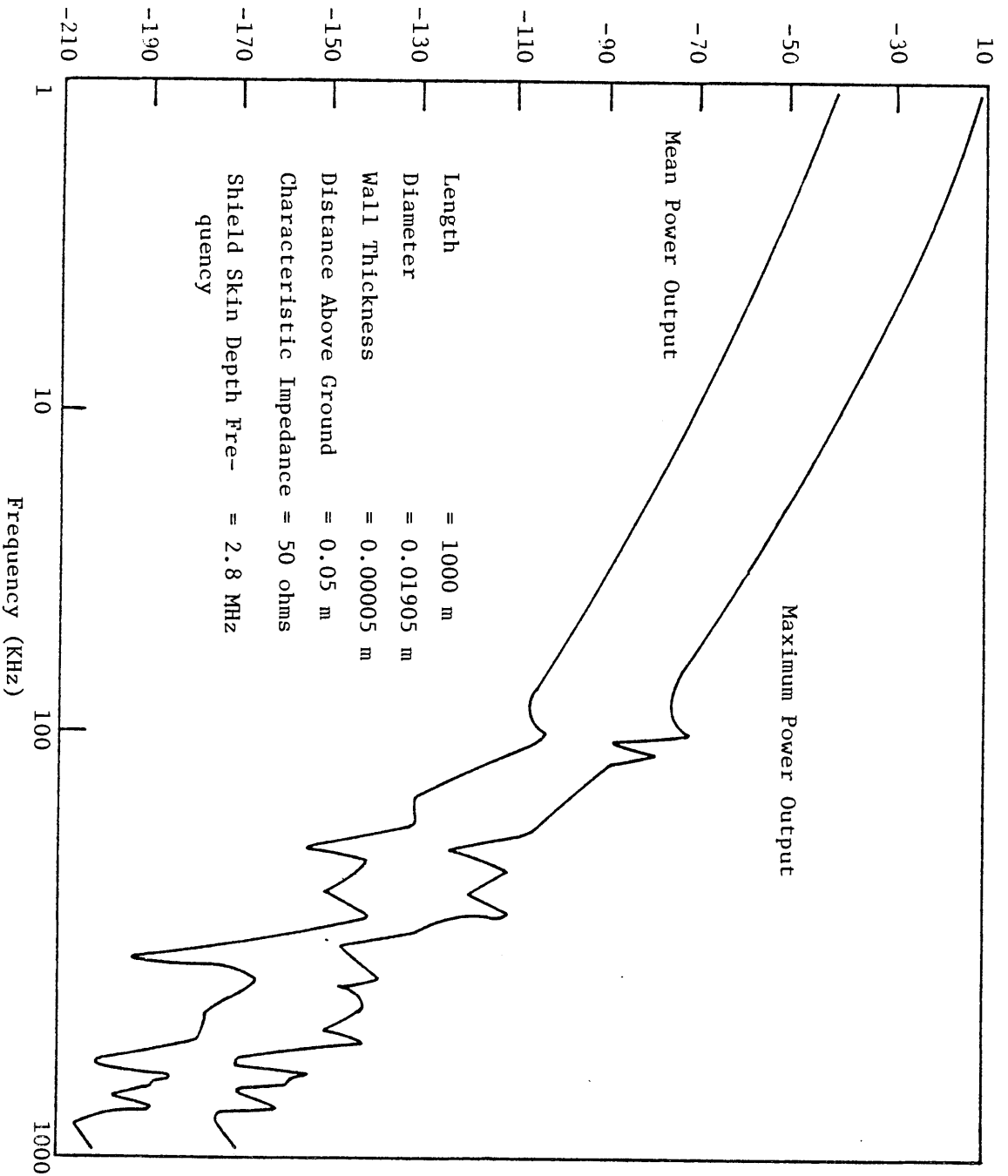

Figure 5.6. Common Mode Power in Load vs Frequency, USBM Special Cable, Shield Grounded on Receiving End.

thorough review of commonly used modulation techniques for mining equipment will be undertaken in the next sections. Similar calculations can be carried out for common mode noise and common mode noise that is changed into differential noise because of "imbalances."

SECTION 6

MINE CHANNEL ERROR PERFORMANCE

6.1. Introduction

Several different digital communication systems have been designed for use within a mining environment. Conspec has developed a communication link which utilizes a special four wire cable for the main part of the communication system and adapter to transmit on twisted pair for longer transmission links. West Virginia University has designed a communication system designated MACCE which utilizes twisted pair communication links. These two systems are examined in detail to determine mathematically the probability of bit error versus distance. [21,22]

Appendix E contains a summary of the most common digital modulation techniques for low speed data links. The formulas given for the bit probability of error are based on the modulation technique, demodulation technique, bandwidth, signal power, and noise power. These formulas assume the noise is white and Gaussian with no other impairments in the system [23-25]. The impairments could include amplitude distortion, phase distortion, crosstalk, impulse noise, and etc. These impairments will tend to increase the bit probability of error but are difficult to analyze [26].

The primary analyses of each communication system will focus on the bit probability of error which will take into account the modulation technique, type of cable, transmitted power, and noise power. The previous sections mathematically determined the noise power present at the output terminals of various types of communication cables that are placed in the mine. This analysis assumed the noise to be represented by a curve of magnetic field intensity versus frequency for the mean and maximum noise cases. The mathematical noise power calculations required a number of assumptions to be made in order to arrive at any answer. The type of electromagnetic waves were assumed to be planar or planar over a section of the wire. Appendix D includes a development of the common mode noise power for a cable if the electromagnetic noise field is approximated by uncorrelated plane waves for only a small portion of the wire. This hopefully more accurately represents the fact that a number of different noise sources exist in the mine. The computer programs for common mode noise made use of the formulas in Appendix D.

The assumptions made in almost all cases are conservative in the sense the bit probability of error should be less than is mathematically derived, i.e. the actual channel performs better. The mathematical development required a number of assumptions and simplifications otherwise the analysis would have been virtually impossible.

6.2. Conspec Data Communication System

Conspec has developed a data communication system which can collect information and control various units primarily using a special 4 wire cable. This

cable is called the accessor trunk and uses one wire for ground, one wire for power (+ 24 volts), one wire for transmit and one wire for receive. USBM has specified a special 4 wire cable that has a shield over each signal conductor as well as a shield over the entire cable. The USBM cable also has a steel cable which provides additional strength. A cross section view is given in Figure 5.5. The modulation used over the accessor trunk is baseband which consists of unipolar 0 volt or 11 volt levels, transmitting asynchronously at 4800 baud. The detector is a nonoptimum (not integrate and dump) type which gives a bit probability of error [25]

$$P_e = \frac{1}{2} \operatorname{erfc} \sqrt{S/N}.$$

The noise equivalent bandwidth is taken to be 15,000 Hz. The actual signal level at the receiving end of the accessor trunk will be a function of length as well as the number of accessors connected to the trunk. Therefore, the probability of error was determined for 5, 8 and 11 volt pulses to give three cases for loading. The characteristics of this communication link and others is given in Table 6.1.

A number of variables exist in such a communication system and would be impossible to plot for all possible cases. The most appropriate plot seems to be a plot of bit probability of error versus distance for reasonable values of the other parameters. A computer program was written which plots the probability of error versus distance and is given in Figure 6.1 for signal levels of 5, 8, and 11 volts with both mean and maximum noise power.

A bit probability of error in the neighborhood of 10^{-5} gives a reasonable good quality channel [23-25]. Therefore, in the worst case of a +5 volt signal and maximum noise power the maximum length cable that could be used is approximately 650 meters. With a signal of 11 volts and mean noise power the maximum length jumps to approximately 2,900 meters.

Conspic uses a long distance accessor trunk (LDA) for transmission over a greater distance. The LDA uses 4 wires with a twisted pair for transmission in each direction. Frequency shift keying is used with the two frequencies being 1200 and 2400 Hz with a transmitted signal strength of 0 dBm (1 milliwatt).

Since this system uses differential transmission it is very important to know the differential noise power. The calculations in the previous sections together with measured data show that the differential noise power is mainly produced by imbalances in the systems which convert a portion of the common mode noise power into differential noise power. Cory [11,12,27] has shown that the conversion can vary considerably, but with a reasonably constructed twisted pair line the differential mode noise should be less than 20 dB below the common mode noise power. Therefore, the computer programs were written which mathematically determined the common mode noise power and reduced this by 20 dB to arrive at the differential noise power. The computer output was plotted to give a probability of error versus distance for the mean and maximum noise case which is given in Figure 6.2. The usable distance for a bit error rate of 10^{-5} is approximately 900 meters to 8,000 meters for the maximum and mean noise power cases, respectively.

Table 6.1
CHARACTERISTICS OF MINE COMMUNICATION LINKS

Manufacturer	Modulation	Power or Voltages Transmitted	Transmission Mode	Baud Rate Bits per Second	Cable Type	Number of Bits per Transmission	Error Detection Scheme
Conspec (Accessor Trunk)	Baseband	0 Volts + 11 Volts	Single Ended	4800 Asynchronous Full Duplex	USBM Cable (4 Wires transmit, receive, +24, Ground)	22 Bits	1 Parity Bit for Each 8 bits, Retransmission on Errors
Conspec (Long Distance Accessor Trunk)	Frequency Shift Keying; 1200 Hz and 2400 Hz	0 dBm (1 Milliwatt)	Differential	600 Asynchronous Full Duplex	4 Wires, (2 Twisted Pairs)	22 Bits	1 Parity Bit for Each 8 Bits, Retransmission on Errors
West Virginia University (MACCE)	Frequency Shift Keying; 1070 Hz, 1270 Hz; 2025 Hz, 2225 Hz	0 to -16 dBm	Differential	300 Asynchronous Full Duplex	Twisted Pair	Variable Number- Maximum is 2048	16 Bits CRC for Header & 16 Bits CRC for Data, Retransmission on Errors

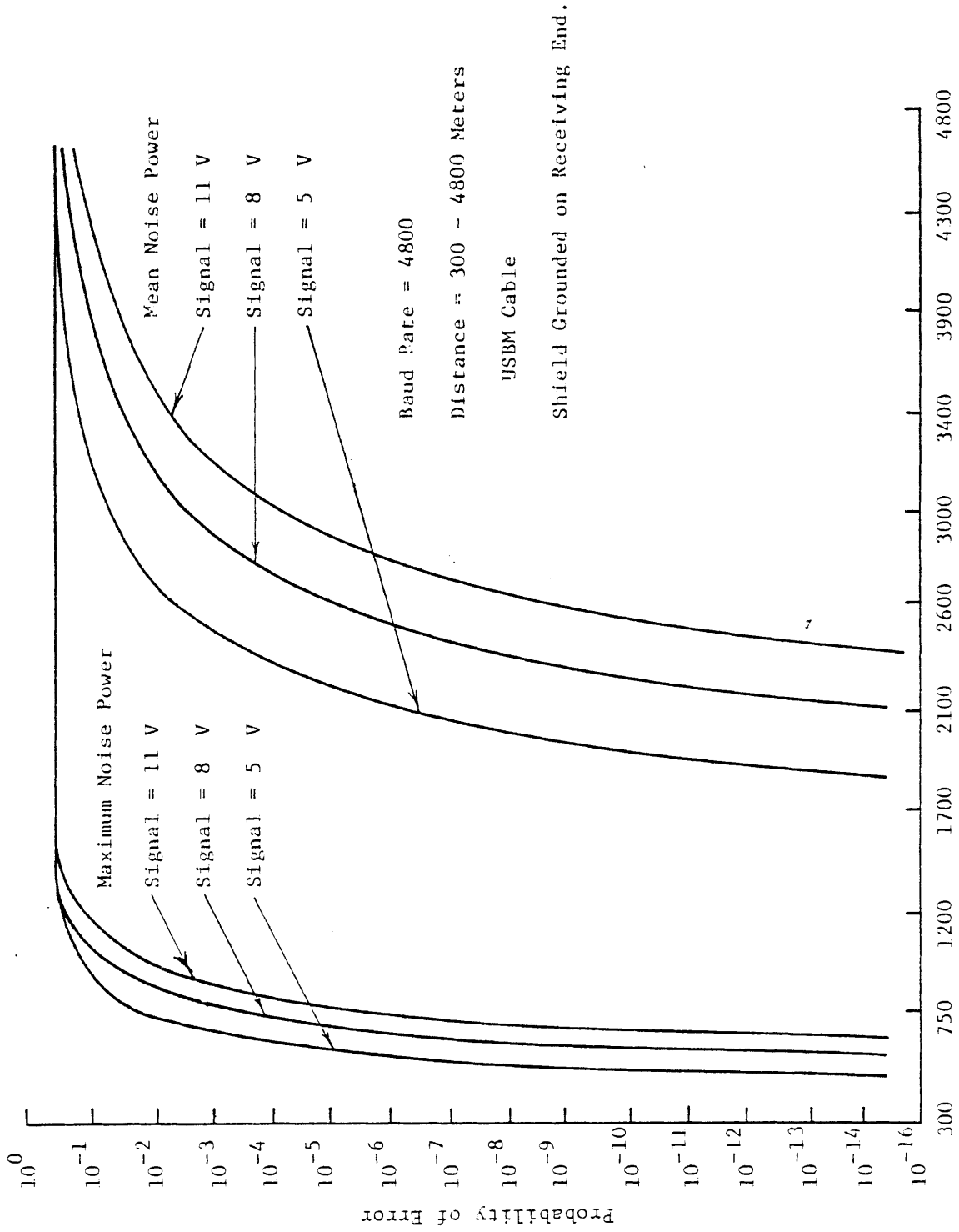

Figure 6.1. Probability of Error Vs Distance (Meters)
Conspec Accessor Link with USBM Cable

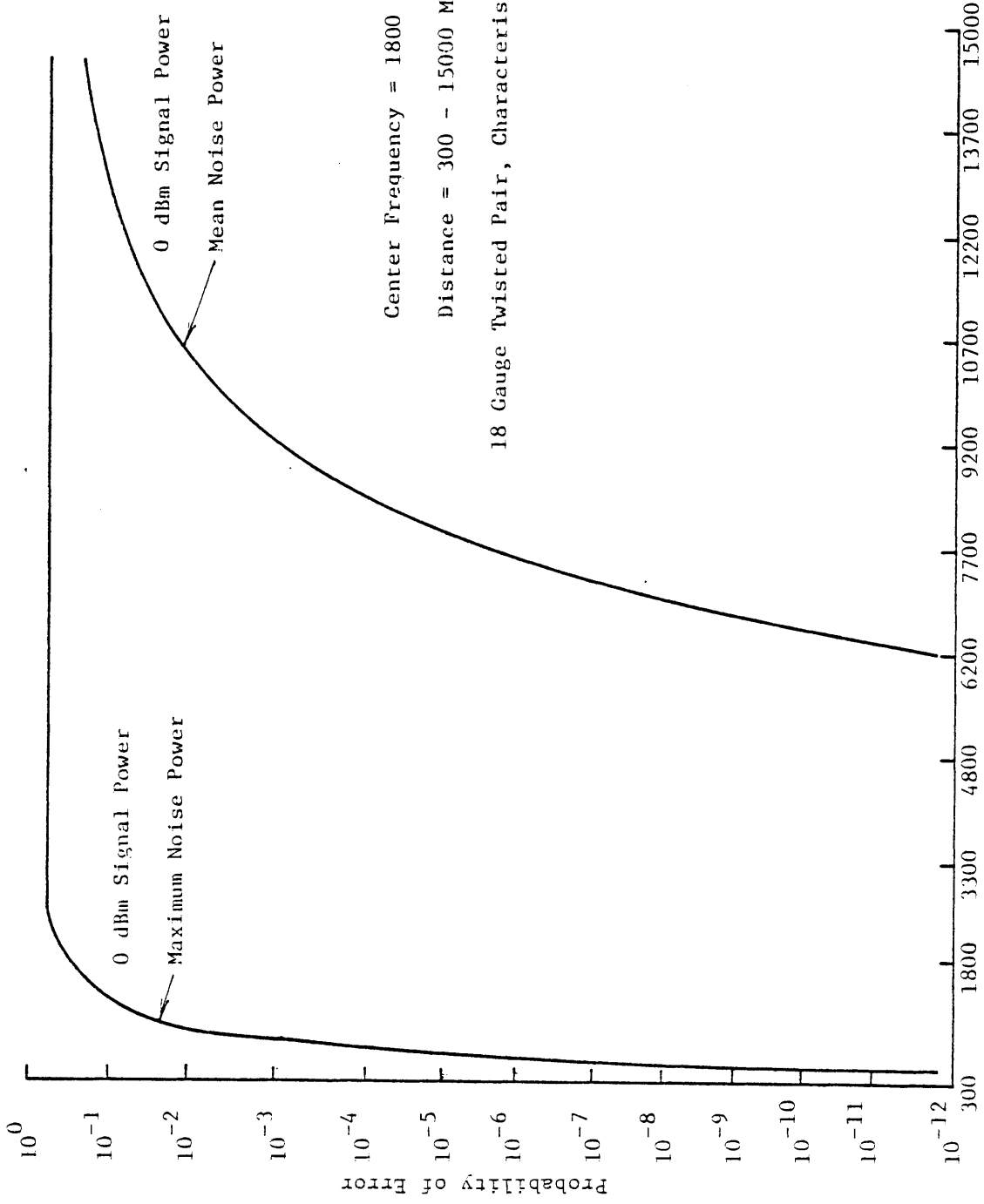

Figure 6.2. Probability of Error Vs Distance (Meters)

Conspec Long Distance Accessor Link

The frequency shift keying demodulator is nonoptimum and the probability of error is (Note Table E.1)

$$P_e = \frac{1}{2} e^{-S/N}$$

A considerable amount of noise enters the receiver because the bandwidth is over 1,200 Hz for the Conspec system.

6.3. West Virginia University MACCE Data Communication System

West Virginia University has designed a mine communication system (MACCE) which uses one twisted pair for both transmitting and receiving [22]. The system employs a frequency shift keying system based on Western Electric's specifications for a 103 series data set (modem). This system uses 1070 Hz and 1270 Hz to transmit in one direction and 2025 Hz, and 2225 Hz to receive. This allows the two signals to be frequency division multiplexed on the same wire. Furthermore, this system typically has the option of transmitting steps from 0 to -16 dBm signal levels.

The same assumptions are used for the conversion of common mode noise to differential mode noise as the Conspec LDA link. The specifications for the MACCE system is given in Table 6.1. The demodulator is of the nonoptimum type so the probability of error is [25]

$$P_e = \frac{1}{2} e^{-S/N}$$

The MACCE system uses two frequency ranges for transmission in two directions and also has the option of different transmitted signal levels. Therefore, to give an orderly presentation four separate figures are given. Figure 6.3 gives the probability of error versus distance for the mean noise case with the center frequency of 1170 Hz and 0 to -16 dBm transmitted signal power. The center frequency is the midpoint of the two transmitted frequencies 1070 Hz and 1270 Hz and is used to determine the noise level. Figure 6.4 gives the probability of error versus distance under the same conditions except the center frequency is 2125 Hz (midpoint of 2025 Hz and 2225 Hz).

The maximum useful distance for the conditions specified in Figure 6.3 with $P_e \approx 10^{-5}$ range from 3,500 meters to 9,900 meters for -16 dBm and 0 dBm transmitted signal power respectively. The similar maximum useful range in Figure 6.4 ranges from 4,400 meters to 12,000 meters when the center frequency is 2,125 Hz. The reason the distance is greater for 2,125 Hz is the noise power falls off as the frequency increases which improves the signal to noise ratio (S/N). Small changes in the signal to noise ratio greatly affect the probability of error which changes the useful range.

Figures 6.5 and 6.6 are the same conditions as Figures 6.3 and 6.4, respectively; except the noise is now maximum. The useful range for $P_e \approx 10^{-5}$ varies from 200 meters (350 Meters) to 900 meters (1200 Meters) for -16 dBm and 0 dBm, respectively, for a center frequency 1170 Hz (2125 Hz) which is

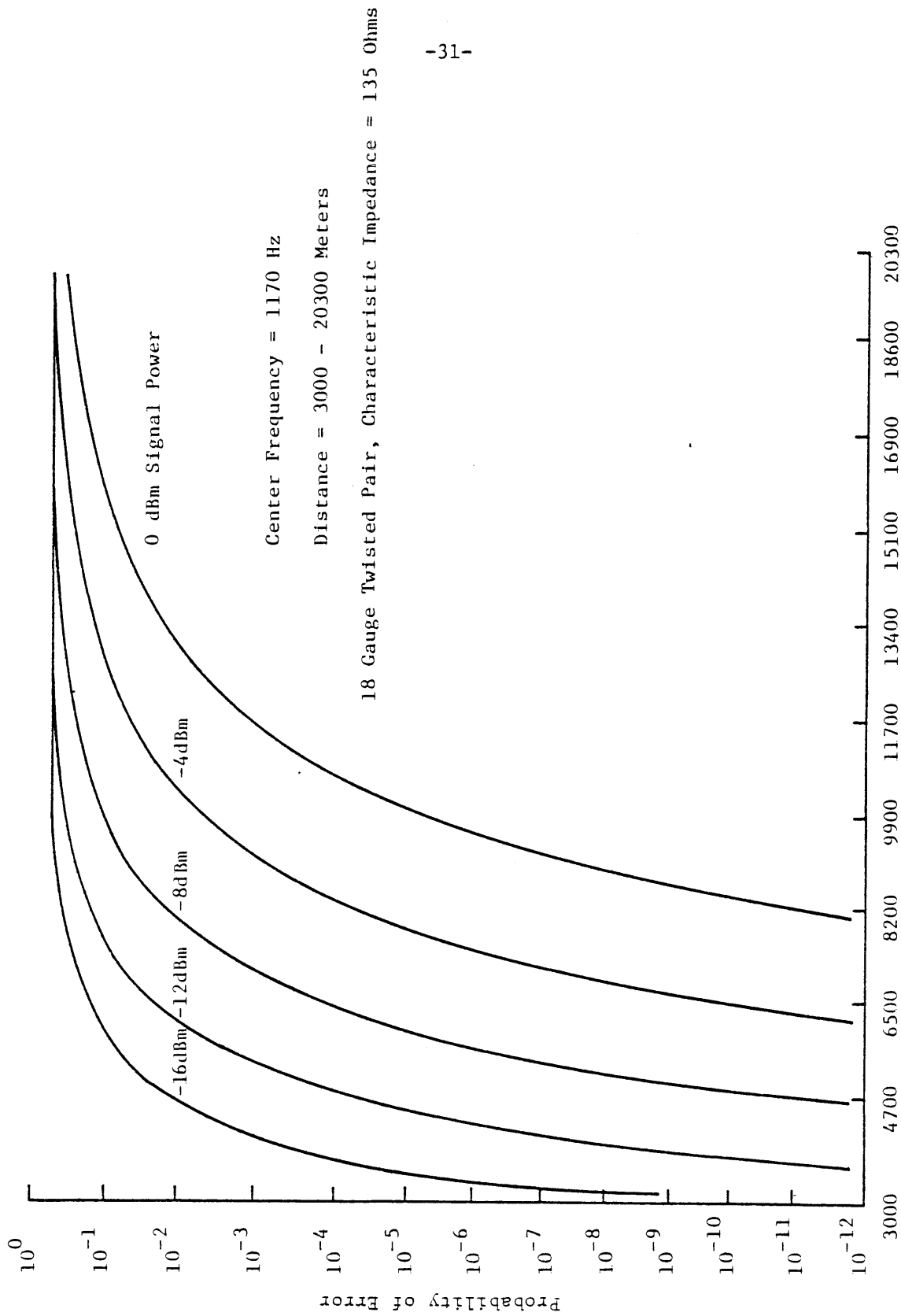

Figure 6.3. Probability of Error Vs Distance (Meters) for Mean Noise Power, West Virginia University MACCE Link, Center Frequency 1170 Hz.

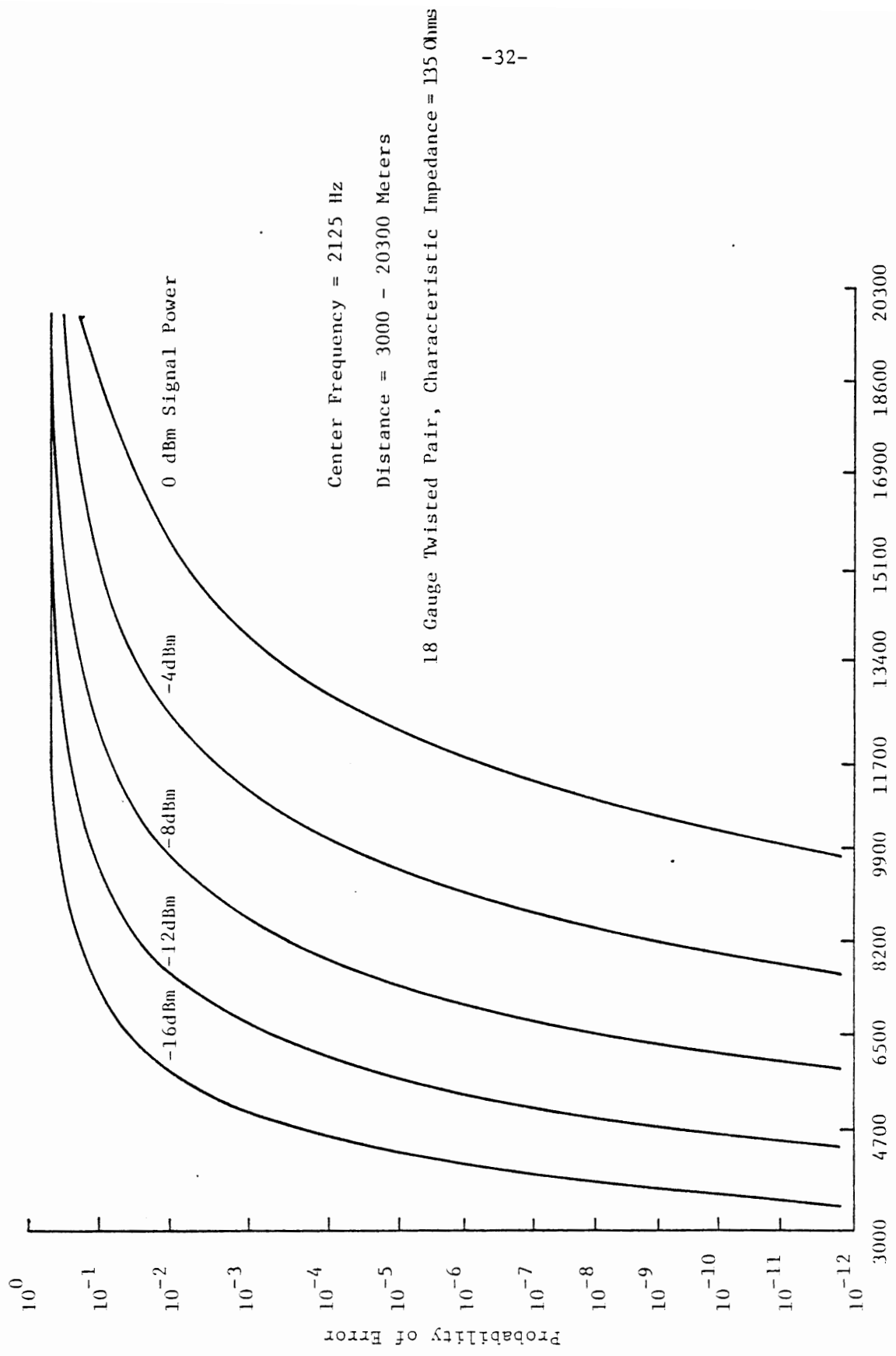

Figure 6.4. Probability of Error Vs Distance (Meters) for Mean Noise Power, West Virginia University MACCE Link, Center Frequency 2125 Hz

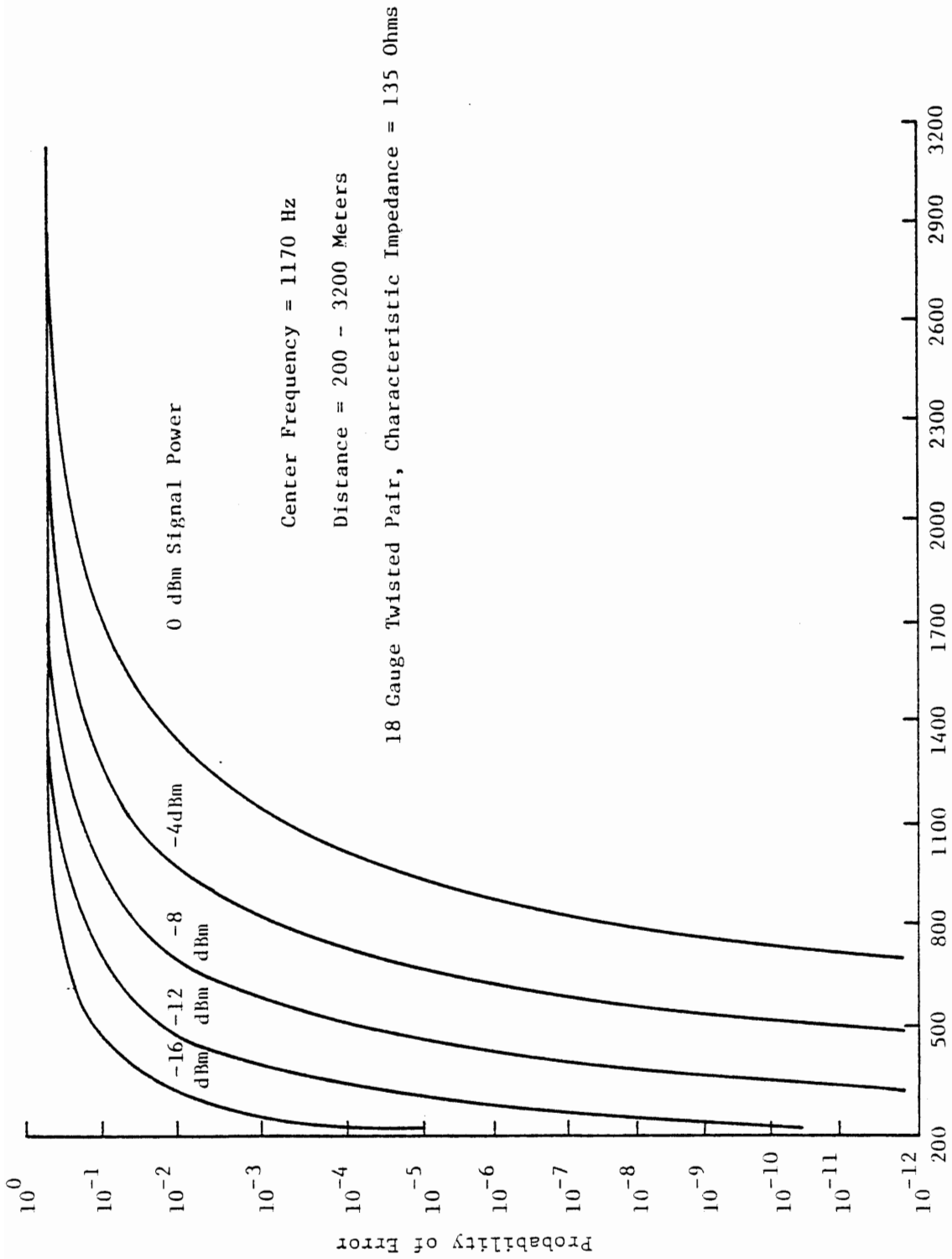

Figure 6.5. Probability of Error Vs Distance (Meters) for Maximum Noise Power, West Virginia MACCE Link, Center Frequency 1170 Hz.

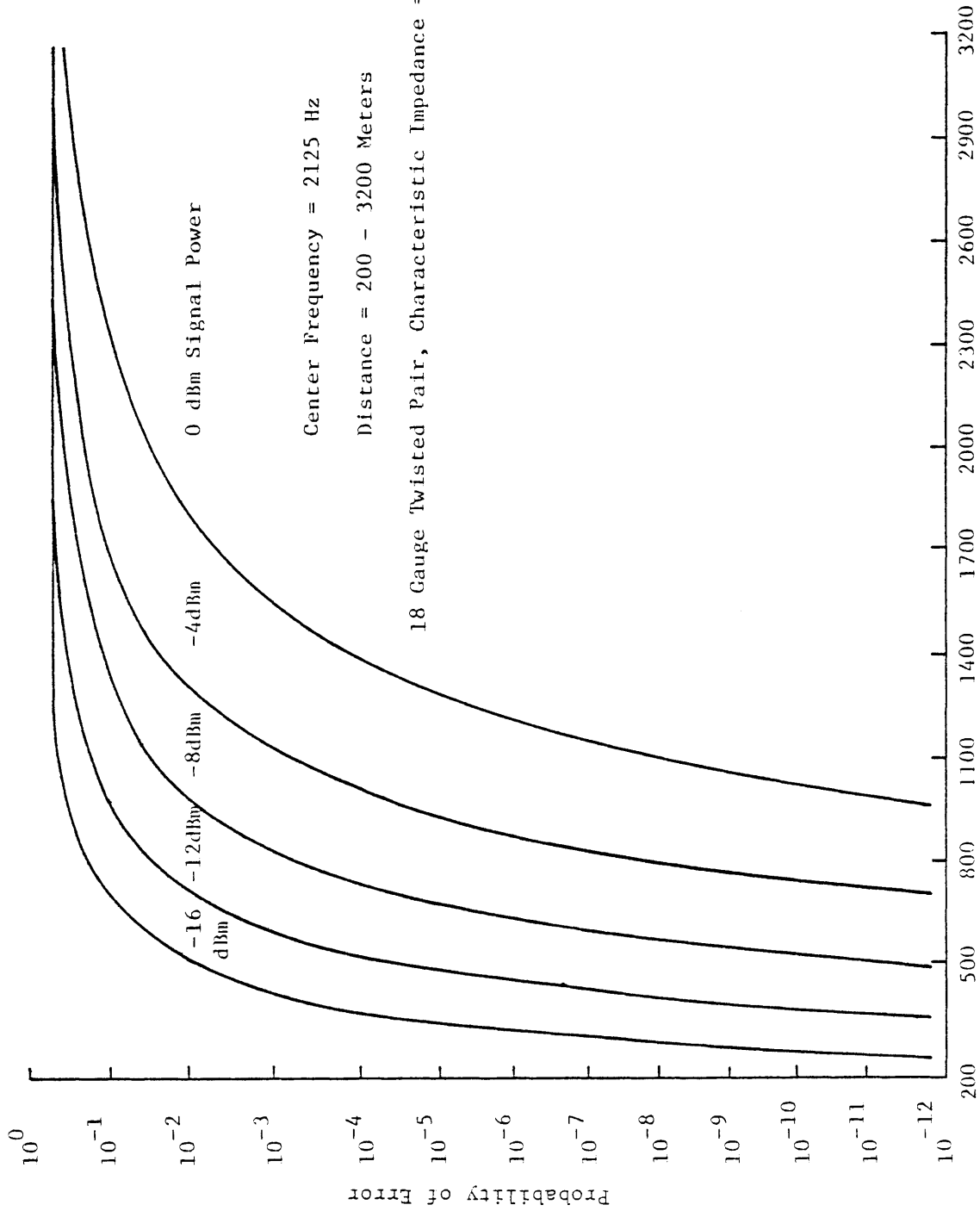

Figure 6.6. Probability of Error Vs Distance (Meters) for Maximum Noise Power, West Virginia University MACCE Link, Center Frequency 2125 Hz

obtained from Figure 6.5 (Figure 6.6). The figures in paranthesis are for Figure 6.6.

The useful range for the MACCE system is obviously limited by the useful distance given for the lower center frequency because both frequency ranges are used simultaneously on the twisted pair. The MACCE system for 0 dBm transmitted signal power has a maximum useful range of 9,900 meters (900 meters) with a mean (maximum) noise level. This information clearly points out that the maximum useful distance is greatly affected by the noise level.

All of these curves were generated assuming the system twisted pair imbalance caused the differential mode noise to be 20 dB below the common mode noise. A better balanced system will obviously increase the maximum useful range of the MACCE Communication System and more imbalance will decrease the useful range.

SECTION 7

DATA SECURITY

7.1. Introduction

Most data communication systems add redundant bits to the messages to improve the data security i.e., reduce the probability of an undetected error. The majority of all data communication systems request a retransmission of the message once an error is detected instead of performing an error correction [28-31]. The hardware is much simpler for error detection than error correction and fewer redundant bits are needed for the same level of data security.

Conspec uses a parity bit for redundancy while West Virginia University MACCE uses a more powerful Cyclic Redundancy Code (CRC). The MACCE System specifies that the Digital Data Communications Message Protocol (DDCMP) is used which is a modern protocol being built into a number of new systems. This protocol is covered in Appendix G.

The amount of data security that is needed is a matter of engineering judgement. The specification usually is given as only one undetected error occurring in say one year, ten years, or possibly for the life of the equipment. The number of blocks on the average which are transmitted before an undetected error occurs is the reciprocal of the probability of undetected error, i.e.

$$\frac{1}{P_{\text{und}}} = \text{Average number of blocks between undetected errors.}$$

The time between an undetected error is

$$\frac{T_B}{P_{\text{und}}} = \text{time between undetected errors}$$

where T_B is the time to send one block of data. Also the time to send one block is

$T_B = N/B$ where N is the number of bits per block and B is the Baud rate. Now let T_{und} be the average time between undetected errors. Therefore,

$$T_{\text{und}} = \frac{N}{B P_{\text{und}}}$$

The value chosen for T_{und} is a matter of engineering judgment as indicated before. The value chosen for T_{und} will be one year in order to make some comparison for this report.

The overall data security of the Conspec and West Virginia University's MACCE Data Communication System will be analyzed. The MACCE system gives a greater deal of protection because of the error detection scheme.

7.2. Conspec Data Communication System

The derivation for the probability of an undetected error is given for the general case in Appendix F. The Conspec System adds one parity bit for each 8 data bits to each asynchronous character that is composed of a start bit, 8 data bits, 1 parity bit, and 1 stop bit for a total of 11 bits for each asynchronous character. The total message is composed of two asynchronous characters for a total of 22 bits [21]. The probability of an undetected error can be found using Appendix F to give

$$P_{\text{und}} = 2(1 - p_e)^9 \sum_{i=2,4,6,8}^9 \binom{9}{i} p_e^i (1-p_e)^{9-i}$$

where p_e is the bit probability of error.

The Baud rate is 4800 for the main accessor trunk and Figure 7.1 gives the probability of undetected error for the same conditions that bit probability of error was given in Figure 6.1. The average time between undetected messages for the main accessor link is

$$T_{\text{und}} = \frac{N}{B P_{\text{und}}} = \frac{22}{4800 \cdot P_{\text{und}}} \text{ seconds}$$

Using $T_{\text{und}} = 1 \text{ year}$

$$P_{\text{und}} = \frac{22}{4800 \cdot (31.5 \times 10^6)} = 1.45 \times 10^{-10}$$

Note there are 31.5×10^6 seconds per year. The maximum useable length of the main accessor trunk using the USBM cable would vary from approximately 600 meters for maximum noise power and 5 volt pulses to approximately 2,700 meters for 11 volt pulses and mean noise power.

Figure 7.2 gives the probability of undetected error for the long distance accessor which uses 600 Baud frequency shift keying. The P_{und} for this case is

$$P_{\text{und}} = \frac{22}{600 \times 31.5 \times 10^6} = 1.16 \times 10^{-9}$$

The useable distance varies from approximately 750 meters for maximum noise power to 7,700 meters for the mean noise power.

7.3. West Virginia University MACCE Data Communication System

The MACCE Data Communication System uses frequency shift keying modulation over a twisted pair similar to Western Electric's 103 series data sets [22]. The MACCE System also specifies the DDCMP protocol which uses a powerful CRC error checking polynomial that can detect single, double, triple,

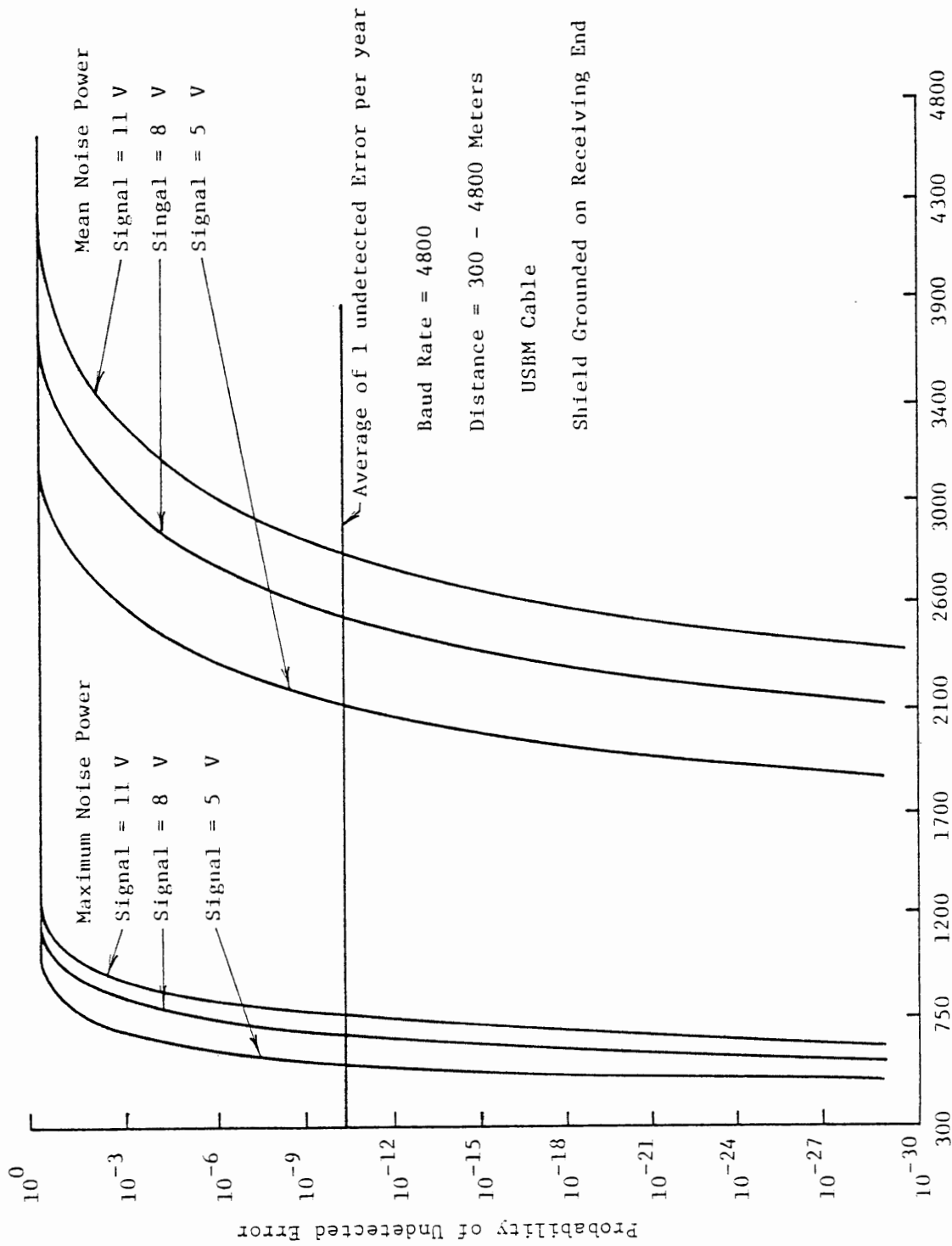

Figure 7.1: Probability of Undetected Error Vs Distance (Meters),
Conspec Accessor Link with USBM Cable

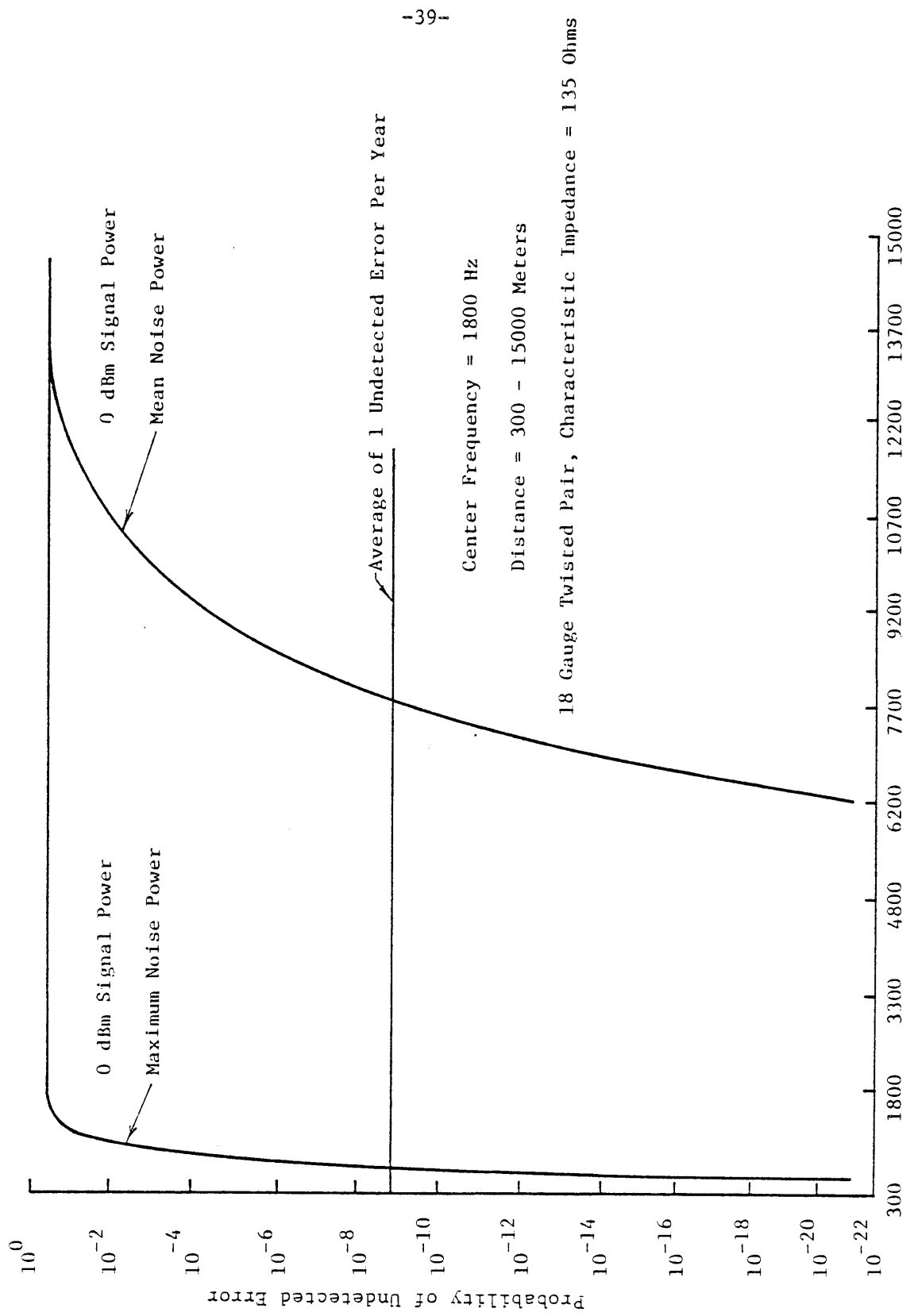

Figure 7.2. Probability of Undetected Error Vs Distance (Meters)
Conspec Long Distance Accessor Link

and all odd random error patterns. The probability of undetected error is

$$P_{\text{und}} = \sum_{i=4,6 \dots n}^n \binom{n}{i} p_e^i (1-p_e)^{n-i}$$

where n is the number of bits and p_e is the bit probability of error.

The P_{und} is a function of n and increases as n increases. Therefore, since the MACCE system specifies a maximum for n of 2048, the worst case analysis will use this value for n [22].

Figures 7.3, 7.4, 7.5, and 7.6 give the probability of undetected error for the MACCE communication link as a function of distance for the two center frequencies, various transmitted signal power, and for mean and maximum noise. Figures 7.3, 7.4, 7.5 and 7.6 correspond to the same conditions as Figures 6.3, 6.4, 6.5 and 6.6, respectively, except the probability of an undetected error is plotted.

The probability of undetected error which produces an average of 1 error per year for the MACCE system with 2048 bits and 300 Baud is

$$P_{\text{und}} = \frac{2048}{300 \times 31.5 \times 10^6} = 2.17 \times 10^{-7}$$

This number is larger than Conspec Values because of Baud rate and a much more powerful error detection code.

The worst case for the MACCE system occurs for the center frequency of 1170 Hz because of more noise power than at 2125 Hz center frequency. Therefore, for the $P_{\text{und}} = 2.17 \times 10^{-7}$ and the mean noise case gives (Figure 7.3) a useful range of approximately 4,200 meters at -16 dBm and approximately 11,000 meters at 0 dBm. Similarly the range varies from approximately 200 meters at -16 dBm to 970 meters at 0 dBm for the maximum noise power (Figure 7.5).

Table 7.1 gives the approximate maximum useable distance for the communication links based on the bit probability of error and probability of undetected error which takes the protocol into account. The table gives a clear indication of greater effectiveness of the better data security given by the CRC polynomial in DDCMP protocol.

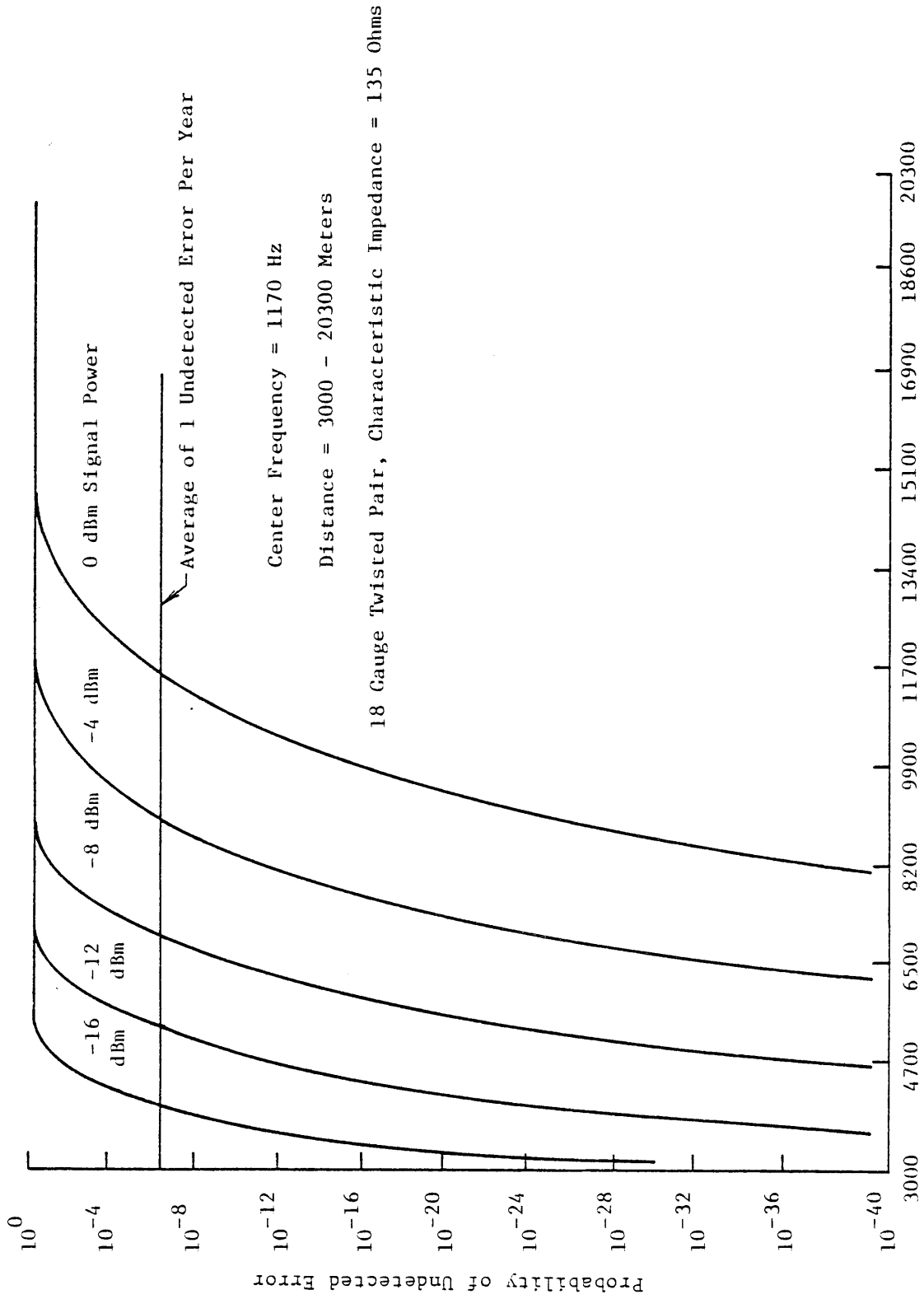

Figure 7.3. Probability of Undetected Error Vs Distance (Meters) for Mean Noise Power, West Virginia University MACCE Link, Center Frequency 1170 Hz

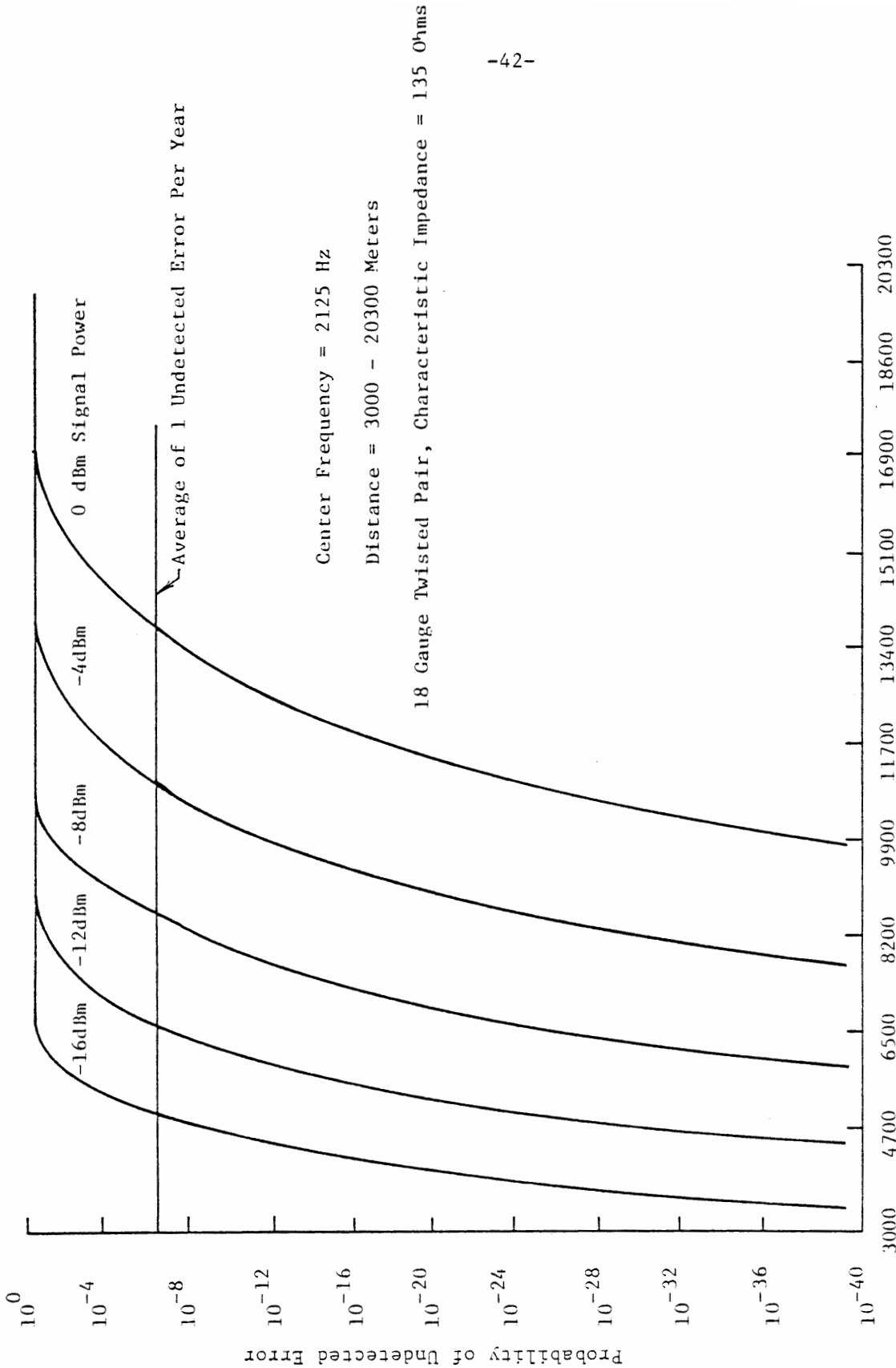

Figure 7.4. Probability of Undetected Error Vs. Distance (Meter) for Mean Noise Power, West Virginia University MACCE Link, Center Frequency 2125 Hz

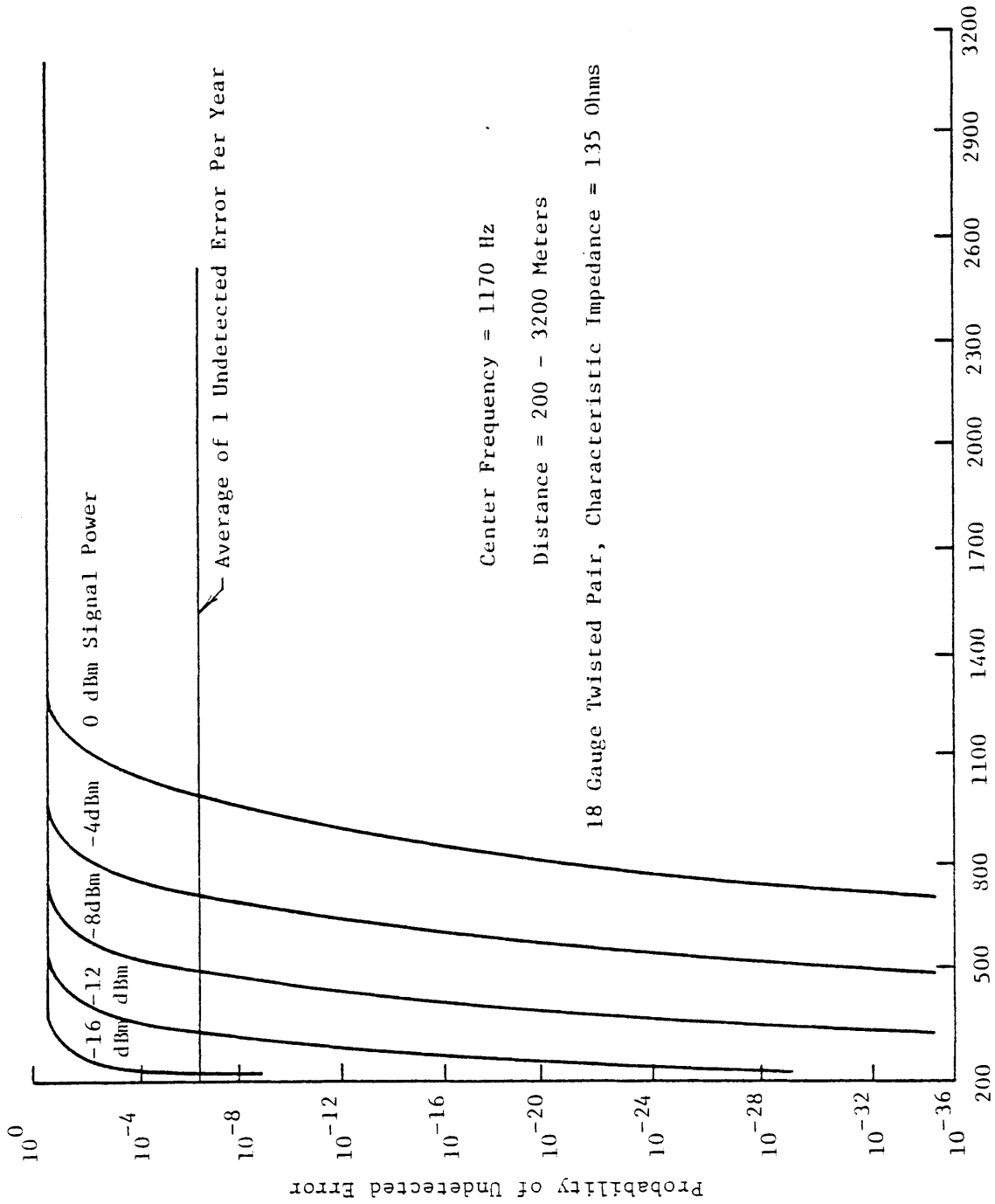

Figure 7.5. Probability of Undetected Error Vs Distance (Meters) for Maximum Noise Power, West Virginia University MACCE Link, Center Frequency 1170 Hz

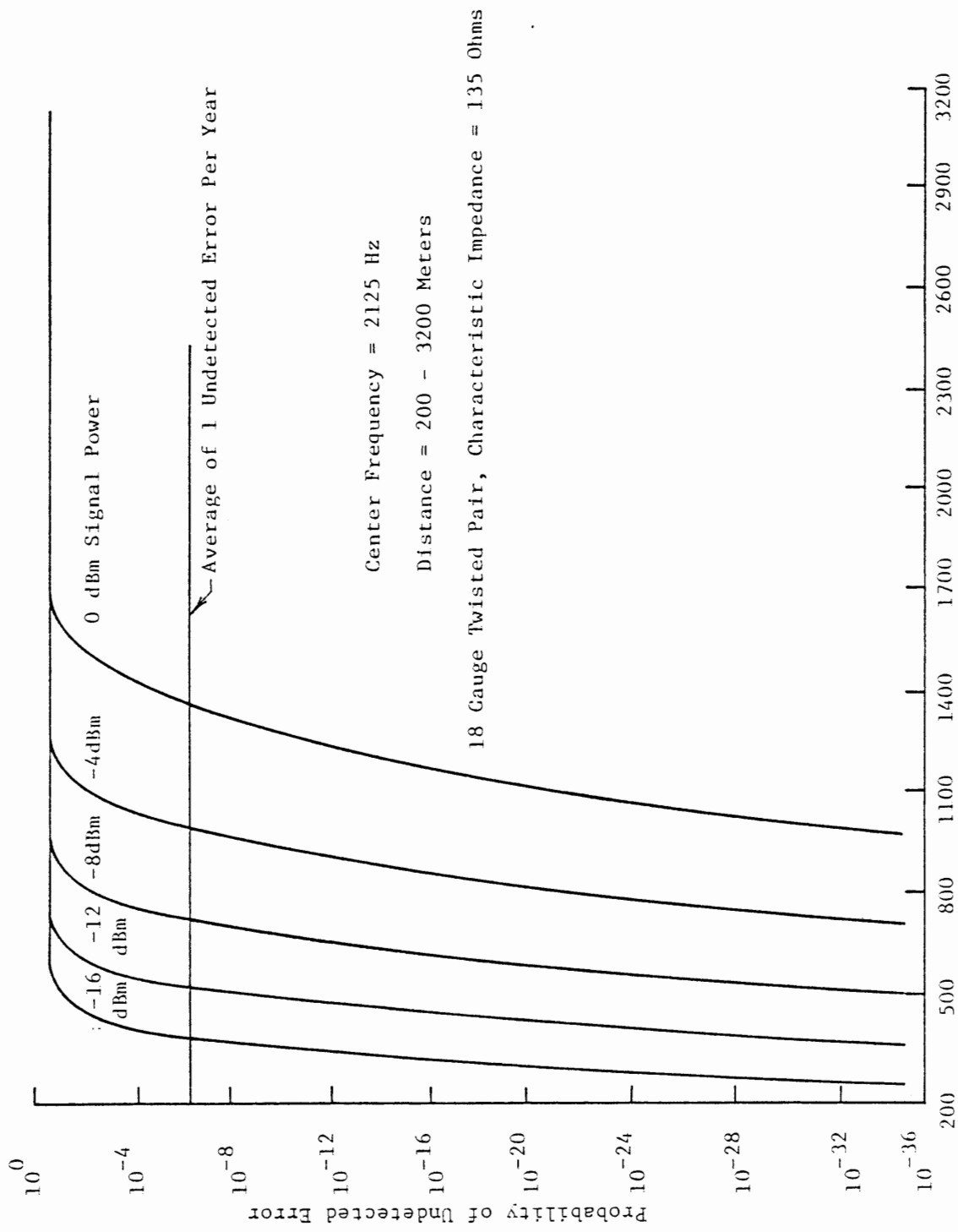

Figure 7-6: Probability of Undetected Error Vs Distance (Meters) for Maximum Noise Power, West Virginia University MACCE Link, Center Frequency 2125 Hz

Manufacturer	Signal Level or Power	Maximum Distance for $p_e = 10^{-5}$		Maximum Distance for 1 undetected error per year	
		Mean Noise	Maximum Noise	Mean Noise	Maximum Noise
Conspec Accessor USBM	5 volts	2,100 (1.3)	650 (.4)	2,100 (1.3)	585 (.4)
	11 volts	2,900 (1.8)	800 (.5)	2,700 (1.7)	750 (.5)
Conspec Long Distance Accessor	0 dBm	8,000 (5.0)	600 (.4)	7,700 (4.8)	750 (.5)
West Virginia MACCE	-16 dBm	3,500 (2.2)	200 (.1)	4,200 (2.6)	200 (.1)
	- 8 dBm	6,500 (4.0)	500 (.3)	6,300 (3.9)	530 (.3)
	0 dBm	9,900 (6.2)	900 (.6)	11,000 (6.8)	970 (.6)

Table 7.1. Approximate Maximum Distances in Meters (Miles) for Useable Communication Links.

SECTION 8

DETECTION OF BURST ERRORS

8.1. Introduction

The question of data security was treated in Section 4 for random errors, i.e., those errors which are independent from 1 bit to the next. Burst errors are error patterns which occur in groups or bursts. If 1 bit is in error, the adjacent bits have a high probability of being in error. The analysis for the probability of an undetected burst is considerably different (see Appendix F). The CRC polynomial can detect any burst error when the length of the burst is equal to or less than the number of redundant bits [31]. Furthermore, a significant number of bursts of length greater than the number of redundant bits can be detected if the number of redundant bits is large.

The probability of a burst being detected given that a burst of a certain length has occurred is easy to calculate. The probability of a burst error passing undetected through the system is the product of the probability of a burst occurring times the probability of being undetected. However, the difficulty is the determination of the probability of a certain length burst occurring.

A sufficient amount of information concerning the occurrence of a burst error noise has not been found in the literature. A simplistic approximation has been found in the literature. A simplistic approximation has been found to burst noise is given in Cory [12], but is not complete. Therefore, the analysis for the different systems will only include the probability of a burst error being undetected given the occurrence of the burst error will be covered.

8.2. Conspec Data Communication System

The Conspec System uses one parity bit for each 8 bits which corresponds to a CRC polynomial $x + 1$ [31]. This system detects all trivial 1 bit burst errors, no double burst errors, and only $\frac{1}{2}$ of all burst of length greater than 2 bits. This same detection system is used for both the normal accessor link and the long distance accessor link.

The burst error protection afforded by the Conspec System is not good. Furthermore, intuitively, the probability of burst errors in a mine will be high because of the large electrical machines. Hence, the overall chances of a burst error passing the system is high.

8.3. West Virginia University MACCE Data Communication System

The MACCE system uses a CRC polynomial of degree 16 which insures all bursts of length 16 or less are detected, only $(\frac{1}{2})^{15} = 3.05 \times 10^{-5}$ bursts of length 17 are undetected, and $(\frac{1}{2})^{16} = 1.5 \times 10^{-5}$ of bursts of length more than 17 are undetected [31]. The burst error protection for the MACCE system is very good.

SECTION 9

CONCLUSIONS AND RECOMMENDATIONS

The electromagnetic noise that exists in a mining environment is quite severe and has been reasonably well documented by a number of researchers. The noise levels are such that prudent communication design requires the careful use of all the electromagnetic noise data available.

A comprehensive survey was undertaken to determine techniques used in various industrial environments to achieve secure communications in the presence of electromagnetic interference. Most of the techniques used are rather rudimentary, but have produced reasonably good results. A number of these techniques can be applied to the mining environment.

A survey of channels used in mine communication systems indicated that 16 and 18 gauge twisted pair wire is the most common type. A rugged plastic sheath and steel messenger cables are sometimes added to provide additional ruggedness. The trolley wire is also extensively used for voice communication. All data that is transmitted requires a very narrow bandwidth for present communication systems. The ever increasing need for higher data rates will require much more sophisticated communication systems and hence, a much more careful design.

A comprehensive theoretical development of noise on mine communication transmission lines for various types of communication links was undertaken. The noise power at the outputs of the links was quite high for most cases. The noise power will greatly affect the data rates on all of these links and must be used to evaluate the overall bit error rates.

A comprehensive development of computer programs was undertaken to determine the bit probability of error for the Conspec Accessor and Long Distance Accessor, and the West Virginia University MACCE data communication systems. This program included the characteristics of the modulation and demodulation techniques and the noise mechanism in which the noise entered the communication link. A set of plots of bit error rate versus distance for the different systems was presented in Section 6.

The protocols used by each data communication link specified a error detection scheme which is intended to detect the most probable errors. The probability of an undetected error then becomes an important parameter for data security. The probability of undetected error versus distance was plotted and presented in Section 7 for the different systems.

Section 8 contains a brief analysis of burst error detection for the different systems. The analysis was limited only to the probability of a burst going undetected given the burst had occurred.

The Conspec and West Virginia University MACCE data communication systems have a reasonable bit probability of error versus distance. The main accessor trunk of Conspec is driven in a single ended mode which is more susceptible than differential mode to external noise.

However, the USBM cable contains two shields and the system transmits a signal of approximately 35 dBm of power which helps reduce the bit probability of error. The long distance accessor and the MACCE system twisted pair cables could be replaced with shielded twisted pair and further increase the effective distance.

The West Virginia University MACCE system specifies the DDCMP protocol which includes a powerful error detecting CRC polynomial. Both Conspec systems use only one parity bit for each 8 data bits which gives limited error detecting capabilities. This error detection scheme limits Conspec range and is also very susceptible to burst errors. The CRC polynomial in DDCMP protocol is therefore the recommended approach.

A number of different protocols exist in the data communication industry which handle the "handshaking" between data terminals. International Business Machine's Synchronous Data Link Control (SDLC) protocol came on the market approximately the same time as DDCMP. SDLC uses a CRC polynomial which has the same random and burst error detecting capabilities as DDCMP, and, therefore, SDLC protocol will not give a better or worse error detection than DDCMP. The error detection is only a small part of any protocol. Formatting, sequencing, acknowledgments, codes, overhead, etc., of each protocol will have a significant affect on data transmission.

It is therefore recommended that a complete evaluation of DDCMP, SDLC and possibly other protocols for the mining environment be undertaken. A mathematical determination of the probability of burst errors occurring so as to determine burst error protection should be examined. Also the effect of shielded twisted pair on error rates should be examined. This information is necessary to insure well designed in-mine communication link that functions properly and provides for excellent data security. This work should be completed before any sophisticated and costly new data communication system be installed in a mining environment.

APPENDIX A

RESPONSE OF A TWISTED PAIR TO INCIDENT
UNIFORM AND NON UNIFORM ELECTROMAGNETIC FIELDS

A.1. Introduction

In this appendix, equations are derived representing the response of a twisted pair to incident uniform and non-uniform electromagnetic fields. Although various kinds of non-uniform fields can exist in real world situations, this discussion is limited to the specific case of a field produced by a small loop. In arriving at the necessary equations, it is convenient to treat the case of a line with parallel conductors and then modify the resulting equations to obtain the response for a twisted pair. Section A.2 treats the general case of a parallel conductor line illuminated by any non-uniform electromagnetic field. Section A.3 deals with the response of a twisted pair due to the field produced by a small current loop is treated.

A.2. Line with Parallel Conductors Illuminated by a Non Uniform Field

Figure A.1 shows an isolated two-wire transmission line with parallel conductors having a diameter 'a' and separated by a distance 'b'. The transmission line is contained in the x-z plane with the conductors parallel to the z-axis and the terminations parallel to the x-axis. Z_1 and Z_2 are the left hand and right-hand terminating impedances respectively.

The line is illuminated by a non-uniform electromagnetic field having an electric field component $E^i(x,y,z,\omega)$ and a magnetic field component $H^i(x,y,z,\omega)$. The direction of propagation of the field is arbitrary as is shown in the Figure A.1. Because of the physical separation of the two conductors the field incident on the two conductors will differ in phase. Because of this phase difference, a net current would flow through the line and the terminating impedances. This current resulting from the phase difference of the incident wave is known as the differential mode current and is the only current flowing in the terminations of a well balanced transmission line. If the line is assumed to be lossless, the differential mode currents I_1 and I_2 flowing through the left-hand and right-hand terminations respectively are given by the following equations [19]:

$$\begin{aligned}
 I_1 = & \frac{1}{D} \int_0^s K(\omega) [Z_0 \cos\beta(s-z) + jZ_2 \sin\beta(s-z)] dz \\
 & + \frac{1}{D} [Z_0 \cos\beta s + jZ_2 \sin\beta s] \int_0^b E_x^i(x,0,0,\omega) dx \\
 & - \frac{Z_0}{D} \int_0^b E_x^i(x,0,s,\omega) dx
 \end{aligned} \tag{A-1}$$

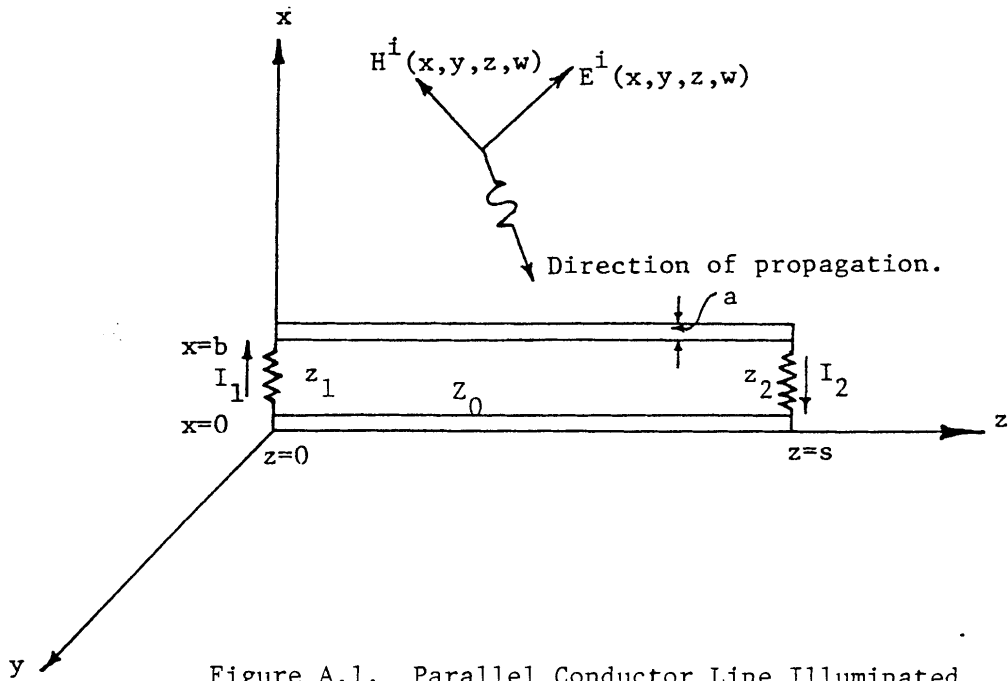

Figure A.1. Parallel Conductor Line Illuminated by a Nonuniform Field

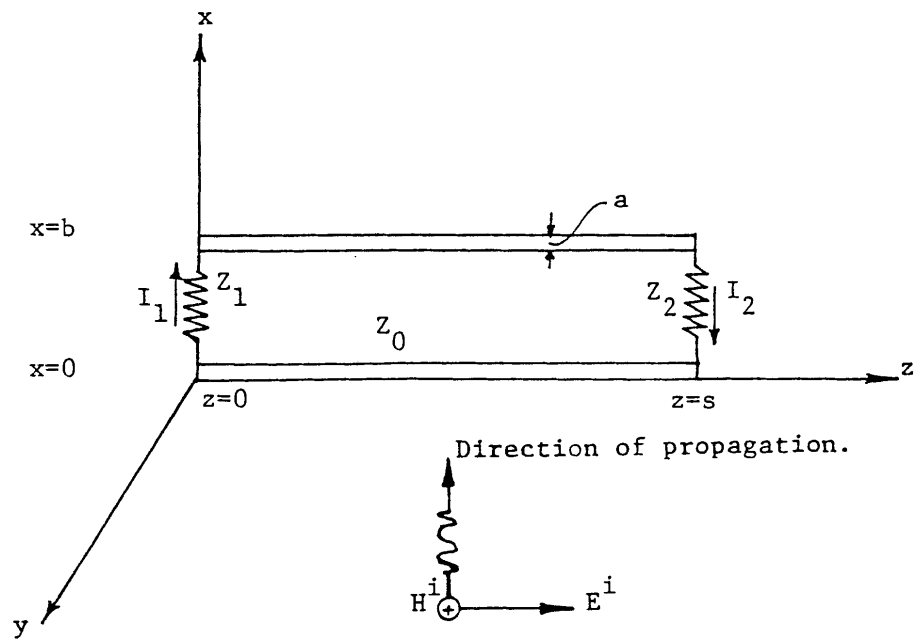

Figure A.2. Parallel Conductor Line Illuminated by a Uniform Plane Wave

$$I_2 = \frac{1}{D} \int_0^s K(\omega) [Z_0 \cos \beta z + jZ_1 \sin \beta z] dz + \frac{Z_0}{D} \int_0^b E_x^i(x, 0, 0, \omega) dx - \frac{1}{D} [Z_0 \cos \beta s + jZ_1 \sin \beta s] \int_0^b E_x^i(x, 0, s, \omega) dx \quad (A-2)$$

where

$$K(\omega) = E_1^i(x, y, z, \omega) - E_2^i(x, y, z, \omega) \quad (A-3)$$

$$D = (Z_0 Z_1 + Z_0 Z_2) \cos \beta s + j(Z_0^2 + Z_1 Z_2) \sin \beta s \quad (A-4)$$

s = the length of the transmission line

$E_1^i(x, y, z, \omega)$ = the component of the incident electric field in the direction of the upper conductor = $E_2^i(b, 0, z, \omega)$.

$E_2^i(x, y, z, \omega)$ component of the incident electric field in the direction of the lower conductor = $E_2^i(0, 0, z, \omega)$.

E_x^i, E_z^i = components of the incident electric field in the x and z directions, respectively.

$Z_0 = \sqrt{Z/Y}$ characteristic impedance of the line

Z = distributed series impedance of the line

Y = distributed series admittance of the line

$\beta = 2\pi/\lambda$ phase constant of the line

λ = wavelength

$\omega = 2\pi f$

f = frequency, hertz

The first term in equations (A-1) and (A-2) represents the contribution along the length of the transmission line and the second and third terms represent the contribution due to the terminations.

Further, we take the case of a uniform plane wave which is travelling in the x-direction and which is plane polarized in such a manner that all its electric field is in the z-direction (as is illustrated in Figure A.2. Since the electric field component of such a wave has a zero component in the x-direction, the second and third terms in equations (A-1) and A-2) are zero. The resulting equations can be expressed as:

$$I_1 = \frac{1}{D} \int_0^S k(\omega) [Z_0 \cos\beta(s-z) + jZ_2 \sin\beta(s-z)] dz \quad (A-5)$$

$$I_2 = \frac{1}{D} \int_0^S k(\omega) [Z_0 \cos\beta z + jZ_1 \sin\beta z] dz \quad (A-6)$$

I_1 and I_2 represent the currents which will flow in the terminating impedances in response to the described incident field provided the line is well balanced.

A.3. Twisted Pair Illuminated by a Uniform Field

Equations (A-5) and (A-6) of the last section can be readily applied to obtain the response of a twisted pair to an illuminating plane wave.

Figure A.3 shows a twisted pair lying along the z-axis. It is illuminated by a uniform plane wave travelling in the x-direction and plane polarized in the z-direction, as is illustrated in the Figure. Each of the conductors w_1 and w_2 in a twisted pair may be regarded as a helix. The twisted pair is assumed to be lying in the z-axis in such a way that the axis of the two helical conductors coincide with the z-axis. Consequently the value of the x-coordinate (x_{w1}) for wire w_1 and for known z is given by

$$x_{w1} = \frac{b}{2} \cos(2\pi z/p) \quad (A-7)$$

where,

p = length of one complete twist (as is illustrated in Figure A.3). Similarly for wire w_2 , the x-co-ordinate (x_{w2}) is given by

$$x_{w2} = -\frac{b}{2} \cos(2\pi z/p) \quad (A-8)$$

Since in an actual twisted pair, the ratio $\frac{b}{p}$ is very small, it may be regarded that $E_z^i(x,y,z,\omega)$ is parallel to the conductors on all points on each of the conductors. If the phase reference is taken to be z-axis, then,

$$E_1^i = E_z^i \cdot e^{-j\beta[\frac{b}{2} \cos(2\pi z/p)]} \quad (A-9)$$

$$E_2^i = E_z^i \cdot e^{+j\beta[\frac{b}{2} \cos(2\pi z/p)]} \quad (A-10)$$

where

E_1^i = Electric field component in the direction of the conductor at any given point on the conductor w_1 .

E_2^i = Electric field component in the direction of the conductor at any given point on the conductor w_2 .

where

E_1^i = Electric field component in the direction of the conductor at any given point on the conductor w_1 .

E_2^i = Electric field component in the direction of the conductor at any given point on the conductor w_2

$$k(\omega) = E_z^i \left[e^{-j\left(\frac{\beta b}{2}\right) \cdot \cos(2\pi z/p)} - e^{+j\left(\frac{\beta b}{2}\right) \cdot \cos(2\pi z/p)} \right] \quad (A-11)$$

or

$$k(\omega) = E_z^i \left\{ -2j \left[\sin\left(\frac{b\beta}{2}\right) \cdot \cos\left[\frac{2\pi z}{p}\right] \right] \right\} \quad (A-12)$$

from Equations (A-5) and (A-12) we can obtain the following equation:

$$\begin{aligned} \frac{I_1}{E_z^i} &= \frac{2}{D} \int_0^S Z_2 \sin\left[\frac{b\beta}{2} \cos\left(\frac{2\pi z}{p}\right)\right] \sin\beta(s-z) dz \\ &+ \frac{2j}{D} \int_0^S Z_0 \sin\left[\frac{b\beta}{2} \cos\left(\frac{2\pi z}{p}\right)\right] \cos\beta(s-z) dz \end{aligned} \quad (A-13)$$

from equations (A-6) and (A-12) we obtain:

$$\begin{aligned} \frac{I_2}{E_z^i} &= \frac{2}{D} \int_0^S Z_1 \sin\left[\frac{b\beta}{2} \cos\left(\frac{2\pi z}{p}\right)\right] \sin\beta z dz \\ &+ \frac{2j}{D} \int_0^S Z_0 \sin\left[\frac{b\beta}{2} \cos\left(\frac{2\pi z}{p}\right)\right] \sin\beta z dz \end{aligned} \quad (A-14)$$

In the above equations, $\frac{I_1}{E_z^i}$ and $\frac{I_2}{E_z^i}$ represent the normalized values of

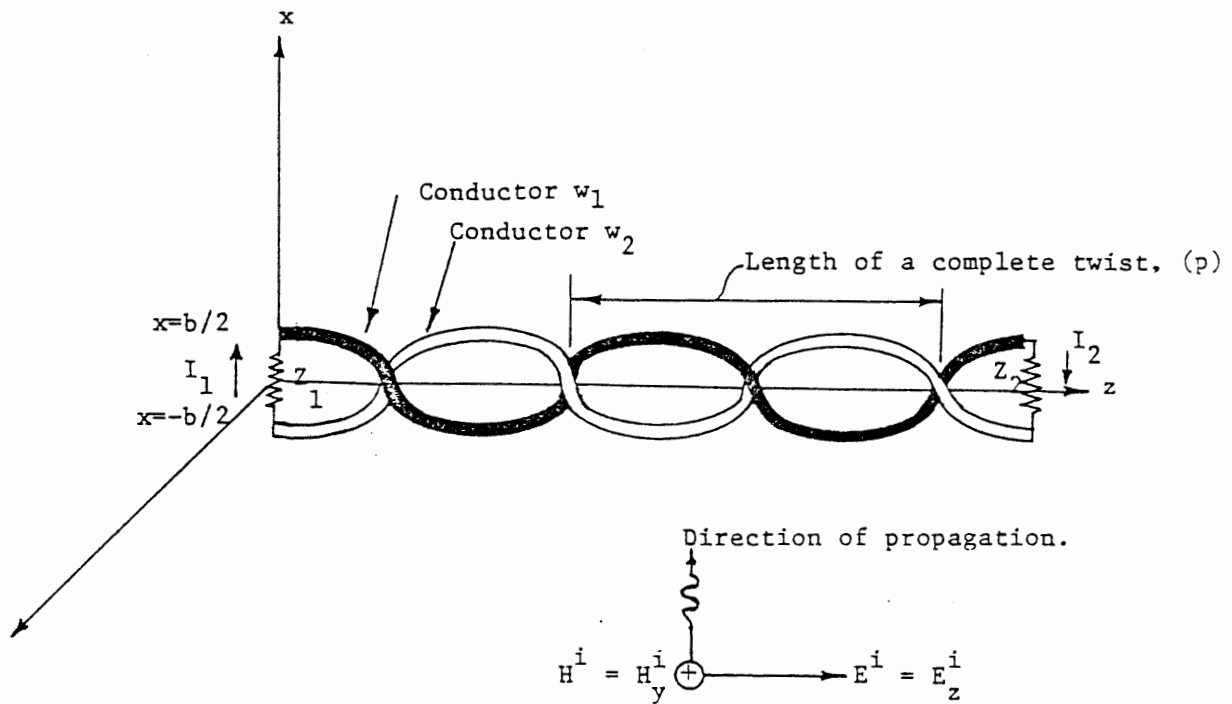

Figure A.3. Twisted Pair Illuminated by a
Uniform Plane Wave

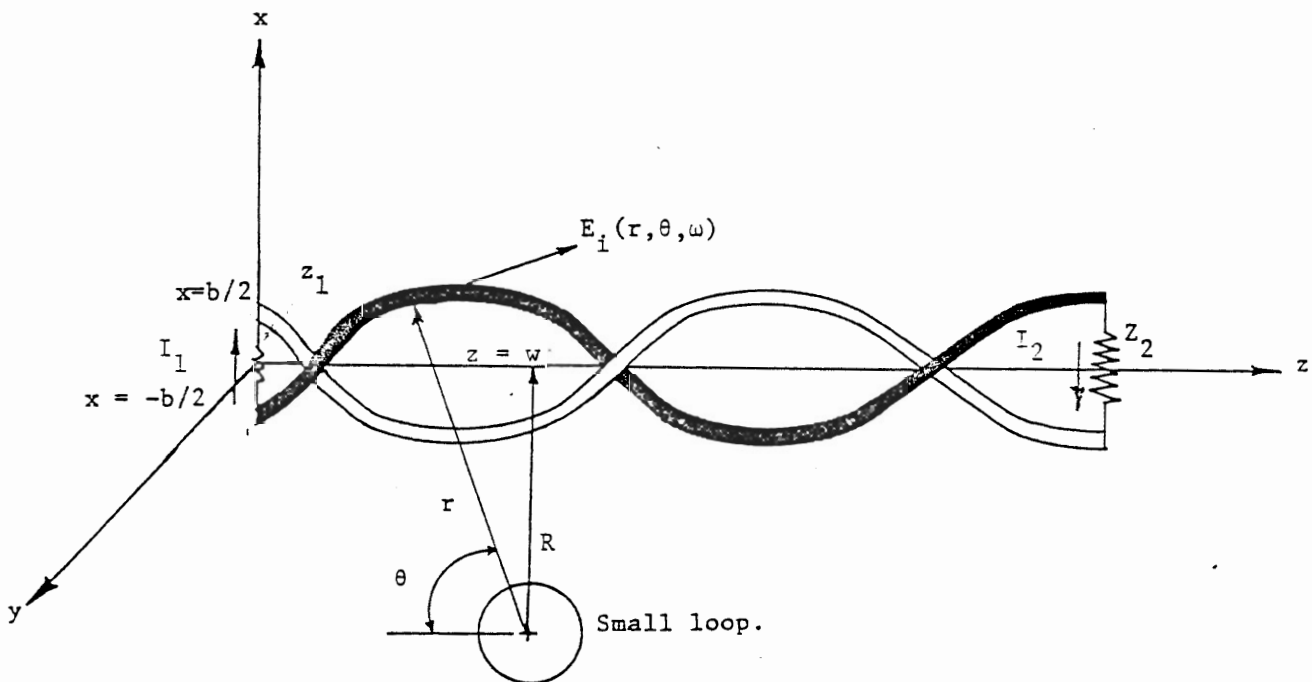

Figure A.4. Twisted Pair Illuminated by
Field Due to a Small Current Loop

the currents flowing through the left-hand and right-hand terminations, respectively, of a well balanced twisted pair. Numerical calculations of the equations (A-13) and (A-14) show that these currents are substantially smaller than the corresponding terminal currents that flow in the case of a parallel conductor line of section A.1.

A.4. Twisted Pair Illuminated by a Field Due to a Small Loop

Figure A.4 shows a twisted pair lying along the z-axis in such a manner that the axis of each of its helical conductors coincides with the z-axis.

The fields radiated by a small current loop can be expressed in the cylindrical co-ordinates by the following equations [19]:

$$\frac{E_z^i(r, \theta, \omega)}{E^i(R, \omega)} = \begin{cases} \left(\frac{R}{r}\right)^2 \sin\theta \cdot e^{-j\beta(r-R)} & \text{Induction Field} & \text{(A-15)} \\ \left(\frac{R}{r}\right) \cdot \sin\theta \cdot e^{-j\beta(r-R)} & \text{Radiation Field} & \text{(A-16)} \end{cases}$$

where,

$E_z^i(r, \theta, \omega)$ is the electric field component of the radiated field at point (r, θ) , in the direction of z-axis.

$E^i(R, \omega)$ is the electric field component of the radiated field distant R from the center of the loop.

R = distance of the loop from the z axis as shown in the Figure, (A.4).

Induction field is important in the region where $\beta r \ll 1$ and radiation field is important in the region where $\beta r \gg 1$. In the region near $z=w$ (see Fig. A.4) both the fields will have comparable contribution.

As in the previous section the ratio b/p for the helical conductors of the twisted pair, is assumed to be small. In such a case direction of each of the conductors can be taken as parallel to the z-axis at all points on the conductors.

Further assume $b \ll R$. Then, from the known conversions from the cylindrical to rectangular co-ordinations and equations (A-7) and (A-8) we have

$$\frac{R}{r} = \frac{R}{\sqrt{(w-z)^2 + \left\{R + \frac{b}{2} \cos(2\pi z/p)\right\}^2}} = h_1(z) \quad \text{(A-17)}$$

$$\sin\theta = \frac{R + \frac{b}{2} \cos(2\pi z/p)}{r_1(z)} = h_2(z) \quad \text{(A-18)}$$

$$r - R = r_1(z) - R = h_3(z) \quad (\text{A-19})$$

where,

$r_1(z)$ is the distance of a point on conductor w_1 from the center of the loop.

Similarly, for points on conductor w_2 we have:

$$\frac{R}{r_2(z)} = \frac{R}{\sqrt{(\omega - z)^2 + \left\{R - \frac{b}{2} \cos(2\pi z | p)\right\}^2}} = h_4(z) \quad (\text{A-20})$$

$$\sin\theta = \frac{R - \frac{b}{2} \cos(2\pi z | p)}{r_2(z)} = h_5(z) \quad (\text{A-21})$$

$$r_2(z) - R = h_6(z) \quad (\text{A-22})$$

where,

$r_2(z)$ is the distance of any point on conductor w_2 from the center of the loop.

Thus,

$$\frac{E_1^i(z, \omega)}{E^i(R, \omega)} = \begin{cases} h_1^2 h_2 [\cos\beta h_3 - j \sin\beta h_3] & \text{Induction (A-23)} \\ h_1 h_2 [\cos\beta h_3 - j \sin\beta h_3] & \text{Radiation (A-24)} \end{cases}$$

$$\frac{E_2^i(z, \omega)}{E^i(R, \omega)} = \begin{cases} h_4^2 h_5 (\cos\beta h_6 - j \sin\beta h_6) & \text{Induction (A-25)} \\ h_4 h_5 (\cos\beta h_6 - j \sin\beta h_6) & \text{Radiation (A-26)} \end{cases}$$

Substituting the value of $K(\omega)$ from equation (A-3) into the equation (A-1) and neglecting the contribution along the terminals we have

$$\begin{aligned} \frac{I_1}{E^i(R, \omega)} &= \frac{1}{D} \int_0^s \frac{E_1^i}{E^i(R, \omega)} [Z_0 \cos\beta (s - z) + jZ_2 \sin\beta(s - z)] dz \\ &- \frac{1}{D} \int_0^s \frac{E_2^i}{E^i(r, \omega)} [Z_0 \cos\beta (s - z) + jZ_2 \sin\beta(s - z)] dz \end{aligned} \quad (A-27)$$

For the induction field, substituting (A-23) and (A-25) in (A-27) we have:

$$\begin{aligned} \frac{I_1}{E^i(r, \omega)} &= \frac{1}{D} \left[Z_0 \int_0^s [h_1^2 h_2 \cos\beta h_3 - h_4^2 h_5 \cos\beta h_6] \cos\beta(s-z) dz \right. \\ &+ Z_2 \int_0^s [h_1^2 h_2 \sin\beta h_3 - h_4^2 h_5 \sin\beta h_6] \sin\beta(s-z) dz \\ &+ jZ_0 \int_0^s [h_4^2 h_5 \sin\beta h_6 - h_1^2 h_2 \sin\beta h_3] \cos\beta(s-z) dz \\ &\left. + jZ_2 \int_0^s [h_1^2 h_2 \cos\beta h_3 - h_4^2 h_5 \cos\beta h_6] \sin\beta(s-z) dz \right] \end{aligned} \quad (A-28)$$

Similarly,

$$\begin{aligned} \frac{I_2}{E^i(R, \omega)} &= \frac{1}{D} \left[Z_0 \int_0^s [h_1^2 h_2 \cos\beta h_3 - h_4^2 h_5 \cos\beta h_6] \cos\beta z dz \right. \\ &+ Z_1 \int_0^s [h_1^2 h_2 \sin\beta h_3 - h_4^2 h_5 \cos\beta h_6] \sin\beta z dz \\ &+ jZ_0 \int_0^s [h_4^2 h_5 \sin\beta h_6 - h_1^2 h_2 \sin\beta h_3] \cos\beta z dz \\ &\left. + jZ_1 \int_0^s [h_1^2 h_2 \cos\beta h_3 - h_4^2 h_5 \cos\beta h_6] \sin\beta z dz \right] \end{aligned} \quad (A-29)$$

$\frac{I_1}{E^i(R, \omega)}$ and $\frac{I_2}{E^i(R, \omega)}$ represent the normalized currents flowing through the ter-

minations of a balanced twisted pair due to the induction field. The corresponding values for the currents due to the radiation field can be obtained by replacing h_1^2 with h_1 and h_4^2 with h_4 in equations (A-28) and (A-29).

APPENDIX B.

NOISE IN SHIELDED CABLES EXCITED BY EXTERNAL
ELECTROMAGNETIC FIELDS

B.1. Introduction

In this appendix, an equation is derived representing the noise current inside a shielded cable in response to an illuminating field external to its shield. In order to keep the mathematics simple, the case of a coaxial cable is considered and the illuminating field is considered to be uniform and oriented with its electric field component in the direction of the cable length. However, the discussion presented here can be easily extended to include any type of field and other types of shielded cables. Section B.2 discusses the general case of a cable excited by an arbitrary field. In section B.3, the equations presented in section B.2 are applied to the specific case of a coaxial cable illuminated by a uniform electromagnetic field. A portion of the discussion in this appendix is taken from Smith [19].

B.2. Shielded Cable Illuminated by an Arbitrary Field

The pertinent geometry of a shielded cable excited by an external electromagnetic field is shown in Figure B.1, where

$E^i(x,y,z,\omega)$	Electric field component of the incident field
$H^i(x,y,z,\omega)$	Magnetic field component of the incident field
$I(z)$	Sheath current distribution
s	Length of the cable, meters
$b/2$	Height of the cable above the ground plane, meters
$Z_1/2, Z_2/2$	Terminating impedances of the cable shield
a	Outside diameter of cable, meters
$Z_o/2$	Characteristic impedance of the cable shield
Z_a, Z_b	Interior load impedances
Z_c	Characteristic impedance of the interior of the cable
I_L	Current in the interior load impedance Z_b
x,y,z	Cartesian coordinates

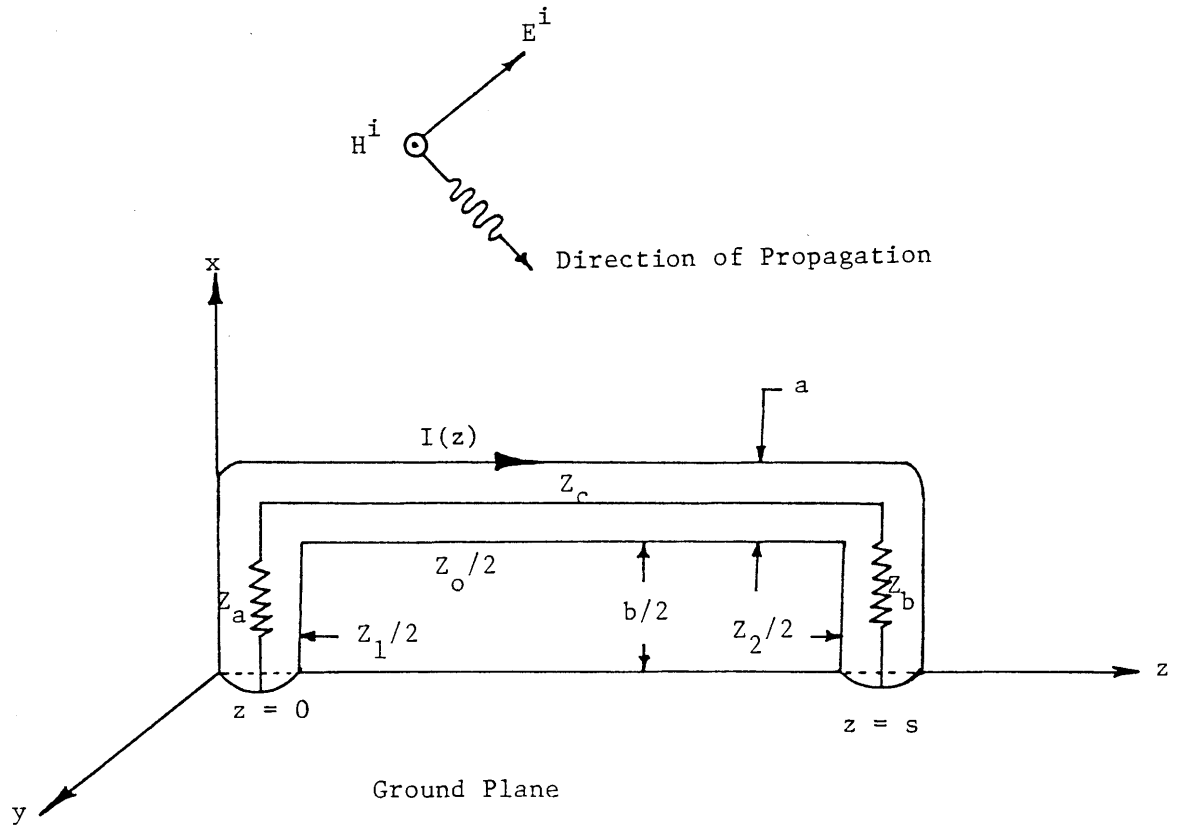

Figure B.1. Shielded Cable Geometry.

The external electromagnetic field excites a current distribution on the outer shield (or sheath). Since the shield is not a perfect conductor, this current penetrates along the inside length of the cable. This voltage distribution in turn produces a current in the interior load impedances. The outer sheath current and the voltage induced along the inside of the cable are related by

$$dV(z) = Z_t I(z) dz \quad (B.1.)$$

where,

Z_t	Surface transfer impedance, ohms/meter
V	Voltage induced along the inside of the cable

(Further information on cable shielding and surface transfer impedance may be found in Reference [32-35] and [17].)

If the length of the cable in Figure B.1 is taken to be much greater than its height above the ground plane ($s \gg b$) then the contribution to the sheath current from the ends can be neglected. The load current $I_L(\omega)$ in the interior load impedance Z_b is obtained by integrating (B.1) over the length of the cable. The appropriate transmission line equation is equation (A.2) with $k(\omega) = Z_t I(z, \omega)$ and $E_x^i = 0$. Thus

$$I_L(\omega) = \frac{Z_t}{P} \int_0^s I(z, \omega) [Z_c \cos \beta_i z + j Z_a \sin \beta_i z] dz \quad (B.2)$$

$$P = (Z_c Z_a + Z_c Z_b) \cos \beta_i s + j (Z_c^2 + Z_a Z_b) \sin \beta_i s$$

$\omega = 2\pi f$ radian frequency

$\beta_i = 2\pi/\lambda_i$ wave number (inside cable)

Although Figure (B.1) depicts a coaxial cable, the approach is valid for any shielded cable, whether balanced or unbalanced (e.g. triaxial, shielded pair, shielded multiconductor, shielded multicoax etc.). It is necessary only to measure the appropriate surface transfer impedance.

Equation (B.2) is a general equation which can be used to calculate the load current spectrum in any shielded cable due to a uniform or non-uniform field of given orientation. Using the transmission line theory, the current $I(z, \omega)$ is first calculated. Subsequent substitution of $I(z, \omega)$ in equation (B.2) and integration yields the value of load current in any shielded cable for a given field.

B.3. Coaxial Cable Illuminated by a Uniform Field

Consider a uniform plane electromagnetic wave traveling in the y-direction and with its incident electric field component $E^i(x, y, z, \omega)$ in the z-direction. Thus

$$E^i(x, y, z, \omega) = E_z^i$$

where

E_z^i is the component of the incident electric field in the z-direction.

The current induced in the sheath can then be calculated using the transmission line theory and taking the effect of ground into consideration. The current induced in the sheath is a common mode current and an expression for it has been derived [19]:

$$I(z, \omega) = \frac{-2jE_z^i}{Z_o \beta} \left\{ 1 - \left\{ [Z_o Z_2 \cos \beta z + Z_o Z_1 \cos \beta (s-z)]/D + j[Z_1 Z_2 \sin \beta z + Z_1 Z_2 \sin \beta (s-z)]/D \right\} \right\} \quad (B.3)$$

where,

$$D = (Z_o Z_1 + Z_o Z_2) \cos \beta s + j(Z_o^2 + Z_1 Z_2) \sin \beta s$$

Assuming that the cable is terminated in its characteristic impedances

i.e.

$$Z_a = Z_b = Z_c = Z$$

Substituting (B-3) in (B-2) and integrating, yields the expression for $I_L(\omega)$.

Thus

$$I_L(\omega) = \frac{-2jZ_t E_z^i Z}{PZ_o \beta} \left\{ \frac{\sin \beta_i s}{\beta_i} - j \frac{(\cos \beta_i s - 1)}{\beta_i} - \frac{1}{2D} \left[\left(\frac{\sin(\beta - \beta_i)s}{\beta - \beta_i} + \frac{\sin(\beta + \beta_i)s}{\beta + \beta_i} \right) \cdot \left(Z_o Z_2 + Z_o Z_1 \cos \beta s + jZ_1 Z_2 \sin \beta s \right) + \left(\frac{\sin(\beta - \beta_i)s}{\beta - \beta_i} - \frac{\sin(\beta + \beta_i)s}{\beta + \beta_i} \right) \right] \right\}$$

$$\cdot \left(Z_1 Z_2 \cos \beta s - Z_1 Z_2 + j Z_0 Z_1 \sin \beta s \right) -$$

$$\left(\frac{\cos(\beta - \beta_i)s - 1}{\beta - \beta_i} + \frac{\cos(\beta + \beta_i)s - 1}{\beta + \beta_i} \right) \cdot \left(Z_0 Z_1 \sin \beta s \right)$$

$$\left. \left. \left. -Z_1 Z_2 \sin \beta s + j(Z_0 Z_2 + Z_1 Z_2 + Z_0 Z_1 \cos \beta s - Z_1 Z_2 \cos \beta s) \right] \right] \right\} \quad (B-4)$$

The above equation represents the noise current flowing in a coaxial cable due to a uniform plane electromagnetic field with its electric field component in the z-direction, assuming the cable is terminated in matching impedances.

APPENDIX C

CONVERSION OF THE COMMON MODE CURRENT
INTO DIFFERENTIAL MODE CURRENT

C.1. Introduction

The conversion of the common mode current into the differential mode current can cause serious noise problems in practical transmission lines. A small fraction of the common mode current usually splits up into differential mode current because of the system imbalance. Since the value of induced common mode current is usually large, even the conversion of a small fraction into differential mode current can cause significant problems.

In this appendix the case of an unbalanced line due to the presence of a small lumped resistance in one of its conductors is discussed. This lumped resistance can be the contact resistance of a soldered joint. It should be noted that the d.c. resistance of a practical transmission line is only of the order of a few ohms (e.g. the d.c. resistance of a 16 A.W.G. single copper conductor of 1000 meters length is about 3.7Ω). Intuitively, then one might expect that even the presence of a one ohm contact resistance can cause significant fraction of the current to split up. A transmission line has associated distributed inductance and capacitance, and the exact analysis of the conversion of the common mode current into differential mode current is complicated and is not discussed here. In section C.2 a d.c. analog of the transmission line circuit is considered, to illustrate how the imbalance can result in current flow in the terminals of this d.c. analog circuit.

C.2. D.C. Analysis of an Unbalanced Transmission Line

Figure C.1 shows the d.c. analog circuit of a transmission line. The resistance R represents the d.c. resistance of each of the conductors of the transmission line and r is a lumped resistor inserted in one of its conductors. Typically, the resistor r may be a contact resistor of a soldered joint in one of the conductors or it may be any other type of resistance, causing imbalance. Z_1 and Z_2 represent the left hand and right hand terminating impedances respectively. Impedances Z represent the impedances of the transmission line to ground. In an actual line they may be mostly capacitive but for the purposes of this discussion they are considered as resistive. The d.c. voltage source of Figure C.1 produces currents I_1 and I_2 . These currents are analogous to the common mode currents induced in a practical transmission line due to excitation by external electromagnetic fields. Because of the lumped resistor in one of the conductors, currents I_1 and I_2 differ in magnitude slightly. This difference results in a net current flow in impedances Z_1 and Z_2 . This current flow can be readily calculated by transforming the Δ -configuration BDG and ACF of Figure C.1 to Y-configurations represented by $B'N_2$, $D'N_2$, $G'N_2$ and $A'N_1$, $C'N_1$, $F'N_1$, in Figure C.2. In Figure C.2,

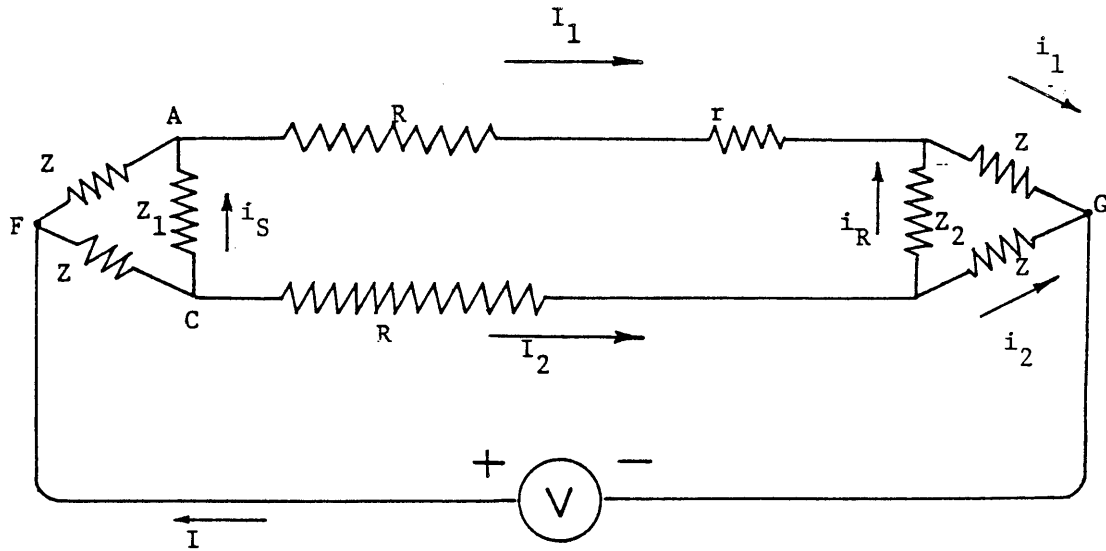

Figure C.1. D.C. Analog Circuit of a Transmission Line

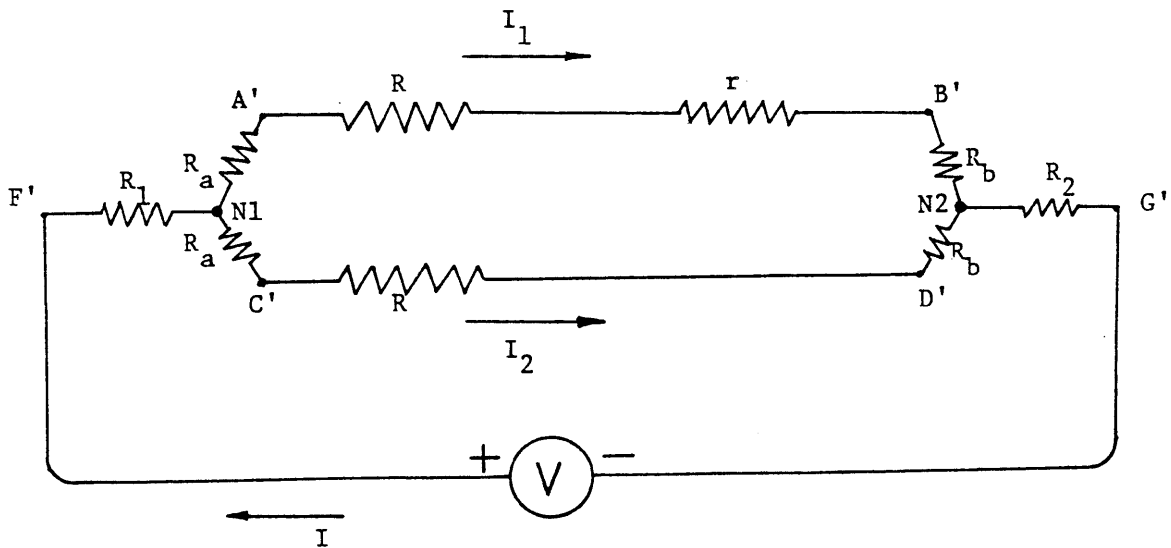

Figure C.2. D.C. Analog Circuit of a Transmission Line
after Δ -Y Transformation

$$R_1 = \frac{Z^2}{2Z + Z_1} \quad (C-1)$$

$$R_2 = \frac{Z^2}{2Z + Z_2} \quad (C-2)$$

$$R_a = \frac{ZZ_1}{2Z + Z_1} \quad (C-3)$$

$$R_b = \frac{ZZ_1}{2Z + Z_2} \quad (C-4)$$

The currents I , I_1 , and I_2 of Figure C.1 are therefore given by the following equations:

$$I = \frac{V}{(R_1 + R_2) + \frac{(R_a + R + r + R_b) \cdot (R_a + R + R_b)}{2(R_a + R + R_b) + r}} \quad (C-5)$$

$$I_1 = I \cdot \frac{R_a + R + R_b}{2(R_a + R + R_b) + r} \quad (C-6)$$

$$I_2 = I \cdot \frac{R_a + R + R_b + r}{2(R_a + R + R_b) + r} \quad (C-7)$$

By writing the loop equation in loop BGD and the node equations at nodes B, G and D, the receiving end current i_R can be derived. Thus,

$$i_R = \left(\frac{Z_2 + 2Z}{Z}\right)(I_1 - I_2) \quad (C-8)$$

Substitution of I_1 and I_2 from (C-6) and (C-7) yields:

$$i_R = I \cdot \left(\frac{Z_2 + 2Z}{Z}\right) \cdot \left(\frac{r}{2(R_a + R + R_b) + r}\right) \quad (C-9)$$

Under the assumptions

$$Z \gg R + r$$

and

$$Z \gg Z_2,$$

equation (C-9) reduces to:

$$i_R = \frac{V}{Z} \cdot \left(\frac{r}{2R + r} \right) \quad (C-10)$$

The result shows that the current i_R resulting from the imbalance is dependent upon the ratio R/r and its magnitude can vary from zero to V/Z . Results obtained from the exact analysis can be expected to be similar.

APPENDIX D

COMMON MODE CURRENT IN A TRANSMISSION LINE HAVING ITS DISJOINT SEGMENTS ILLUMINATED BY UNCORRELATED UNIFORM FIELDS

D.1. Introduction

It was discussed in previous sections, that in practical transmission lines, the value of the Common Mode Current induced due to external electromagnetic fields can be large. If a small fraction of this current splits up into the differential mode current due to the system imbalance, it can cause serious noise problems. Therefore it is of concern to be able to calculate the value of the induced common mode current, fairly accurately. An expression for the calculation of the common mode current was given in Appendix B, equation (B-3) for a single wire transmission line, when such a line is in the proximity of a perfectly conducting ground plane, and is illuminated by a uniform field along its entire length. However in a mining environment, it is not likely that a transmission line will be illuminated by the same uniform field throughout its length. It is reasonable to assume that different sections of a line will be illuminated by either uniform or nonuniform fields. In this appendix, an equation is derived for the common mode current in a line whose various sections are illuminated by different fields. If the segments are chosen small enough, any field may be considered uniform within a segment length. Therefore the derivation of the equation in Section A.2., is limited to the case where the various segments of a line are illuminated by uniform fields only. A portion of the discussion in the following section is taken from Smith [1].

D.2. Derivation of the Equation

Figure D-1(a) shows a single wire transmission line. It is of length S and terminated at both ends to a perfectly conducting ground plane. The terminating impedances are $Z_1/2$ and $Z_2/2$ as is shown in the Figure. The wire is of diameter 'a' and the distance between the wire and the ground is chosen to be $b/2$. It is illuminated by a uniform plane wave traveling in the z -direction and having its electric field component oriented in the x -direction. An expression for the common mode current can be derived using the transmission line equations and using the image theory to take the effect of ground into consideration. Figure D.1(b) shows the ground plane replaced by an image of the wire and its terminations. The necessary image field is also shown in the same figure. Assuming the line to be lossless, the expression for the common mode current $I(z^*, \omega)$ at any point z^* along the line can be expressed in the integral form as [19].

$$I(z^*, \omega) = \frac{Z_0 \cos \beta(s-z^*) + jZ_2 \sin \beta(s-z^*)}{Z_0 D} \int_0^{z^*} 2E_z^i [Z_0 \cos \beta z + jZ_1 \sin \beta z] dz$$

$$+ \frac{Z_0 \cos \beta z^* + jZ_1 \sin \beta z^*}{Z_0 D} \int_{z^*}^s 2E_z^i [Z_0 \cos \beta(s-z) + jZ_2 \sin \beta(s-z)] dz$$

(D-1)

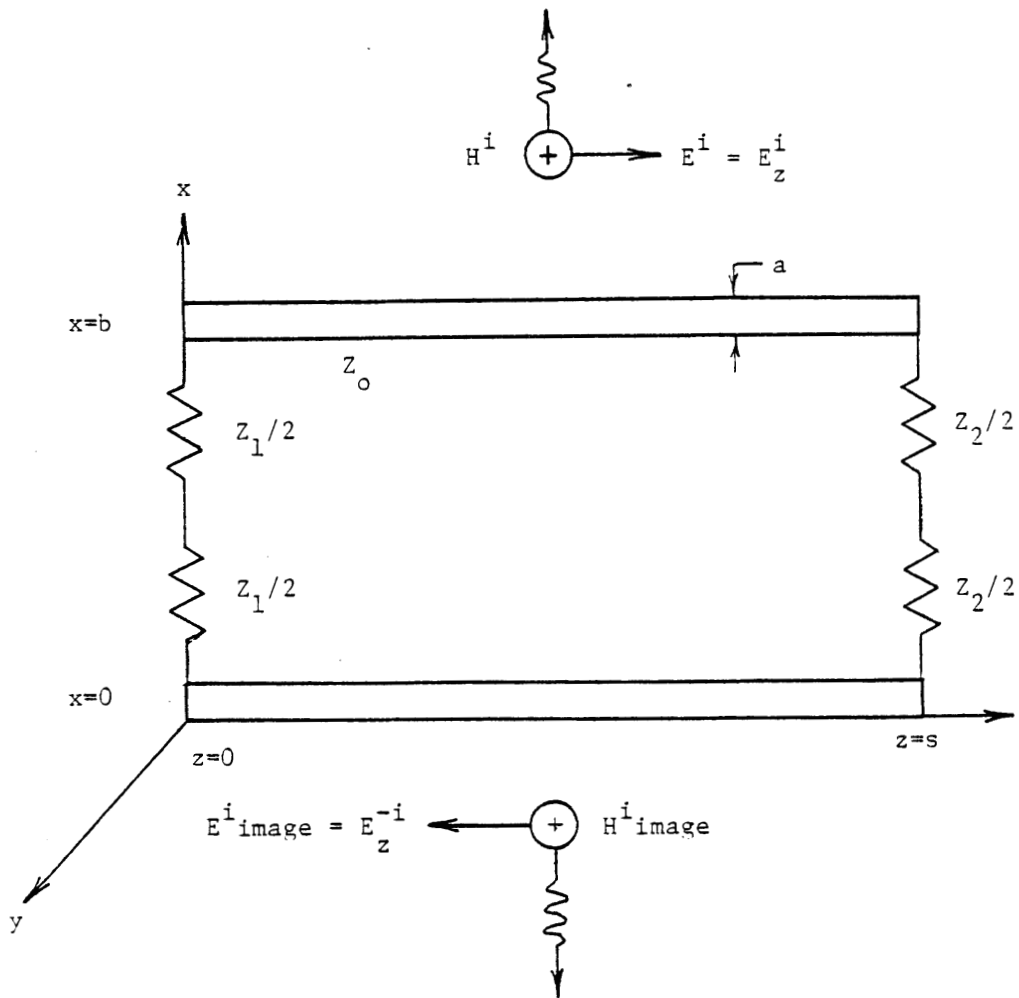
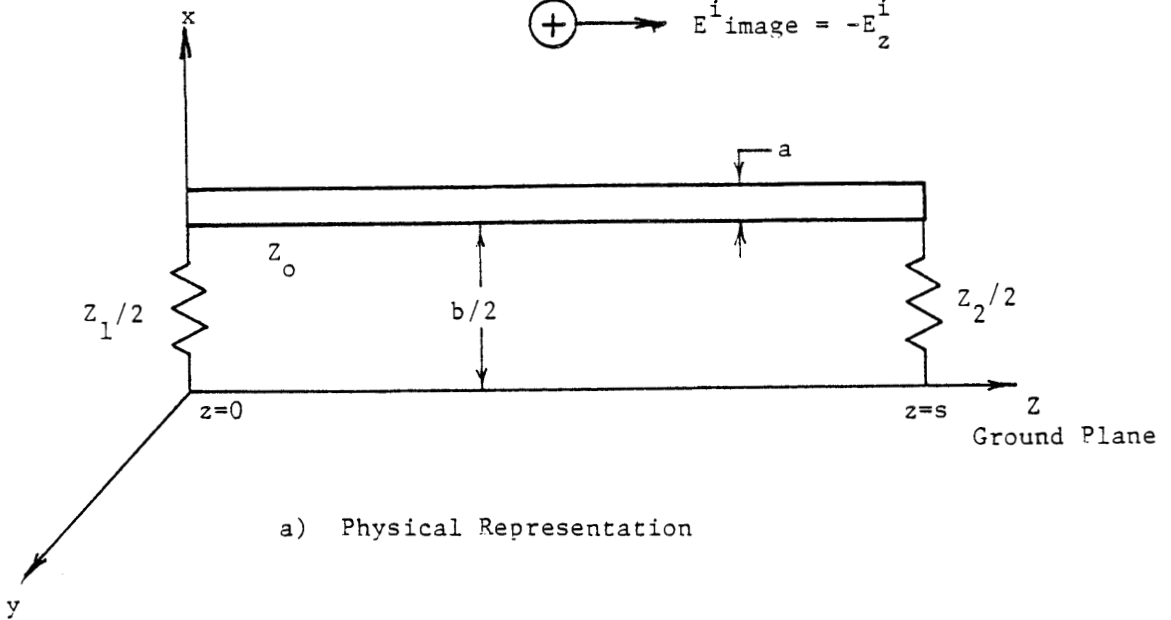
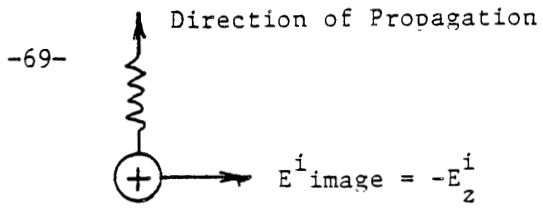

Figure D.1. Wire Over a Ground Plane.

where,

$Z_0 = Z/Y =$ characteristic impedance of equivalent two-wire line (i.e. the wire and its image)

$Z =$ distributed series impedance of the equivalent two-wire line.

$Y =$ distributed shunt admittance of equivalent two-wire line.

$D = (Z_0 Z_1 + Z_0 Z_2) \cos \beta s + (Z_0^2 + Z_1 Z_2) \sin \beta s$

$E_z^i(x, y, \omega) =$ incident field in z-direction along the wire

$\beta = 2\pi/\lambda$, phase constant

$\omega = 2\pi f$

$f =$ frequency, hertz

Equation (D-1) can be easily modified to obtain the required equation for the common mode current in a transmission line whose different segments are illuminated by different fields. Figure D-2 shows a short segment of length Δz ($s/\Delta z$ is an integer) illuminated by some field $E_z^i(x, y, \omega)$. It is assumed that the segment is short, so that $E_z^i(x, y, \omega)$ can be considered uniform along the segment length. Further, let $u/\Delta z = m$ and $\tau/\Delta z = m - 1$, and let $E_z^i(z, y, \omega)$ be defined by the equation below:

$$\text{i.e. } E_z^i(x, z, \omega) = \begin{cases} E_z^i_m & \tau \leq z \leq u \\ 0 & \text{elsewhere} \end{cases} \quad (\text{D-2})$$

For $z^* \geq u$, substituting the value of E_z^i from (D-2) in (D-1):

$$I_{m+}(z^*, \omega) = \frac{[Z_0 \cos \beta(s-z) + jZ_2 \sin \beta(s-z)]}{Z_0 D \beta} \cdot 2E_z^i_1.$$

$$\left\{ Z_0 (\sin \beta u - \sin \beta \tau) - jZ_1 (\cos \beta u - \cos \beta \tau) \right\} \quad (\text{D-3})$$

where

$I_{m+}(z^*, \omega) =$ common mode current at z^* (for $z^* \geq u$) due the illumination of m th segment.

Similarly for $z^* \leq \tau$, substituting (D-2) in (D-1):

$$I_{m-}(z^*, \omega) = \frac{[Z_0 \cos \beta z + jZ_1 \sin \beta z]}{Z_0 D \beta} \cdot 2E_z^i \cdot \left\{ Z_0 [\sin \beta (s-\tau) - \sin \beta (s-u)] + jZ_2 [\cos \beta (s-u) - \cos \beta (s-\tau)] \right\} \quad (D-4)$$

where

$I_{m-}(z^*, \omega)$ = common mode current at z^* (for $z^* \leq \tau$) due to the illumination of m th segment.

Combining (D-3) and (D-4) and substituting $z^* = z$.

$$I_m(z, \omega) = \frac{[Z_0 \cos \beta z + jZ_1 \sin \beta z]}{Z_0 D \beta} \cdot 2E_{zm}^i \cdot [Z_0 (\sin \beta (s-\tau) - \sin \beta (s-u)) + jZ_2 (\cos \beta (s-u) - \cos \beta (s-\tau))] + \frac{[Z_0 \cos \beta (s-z) + jZ_2 \sin \beta (s-z)]}{Z_0 D \beta} \cdot 2E_{zm}^i \cdot [Z_0 (\sin \beta u - \sin \beta \tau) - jZ_1 (\cos \beta u - \cos \beta \tau)] \quad (D-5)$$

Substituting $\tau = (m-1)\Delta z$ and $u = m\Delta z$:

$$I_m(z, \omega) = \frac{[Z_0 \cos \beta z + jZ_1 \sin \beta z]}{Z_0 D \beta} \cdot 2E_{zm}^i \cdot [Z_0 (\sin \beta (s-m\Delta z) - \sin \beta (s-(m-1)\Delta z)) + jZ_2 ((\cos \beta (s-m\Delta z) - \cos \beta (s-(m-1)\Delta z)))] + \frac{[Z_0 \cos \beta (s-z) + jZ_2 \sin \beta (s-z)]}{Z_0 D \beta} \cdot 2E_{zm}^i \cdot [Z_0 \sin \beta m\Delta z - \cos \beta (m-1)\Delta z) + jZ_2 ((\cos \beta m\Delta z - \cos \beta (m-1)\Delta z))] \quad (D-6)$$

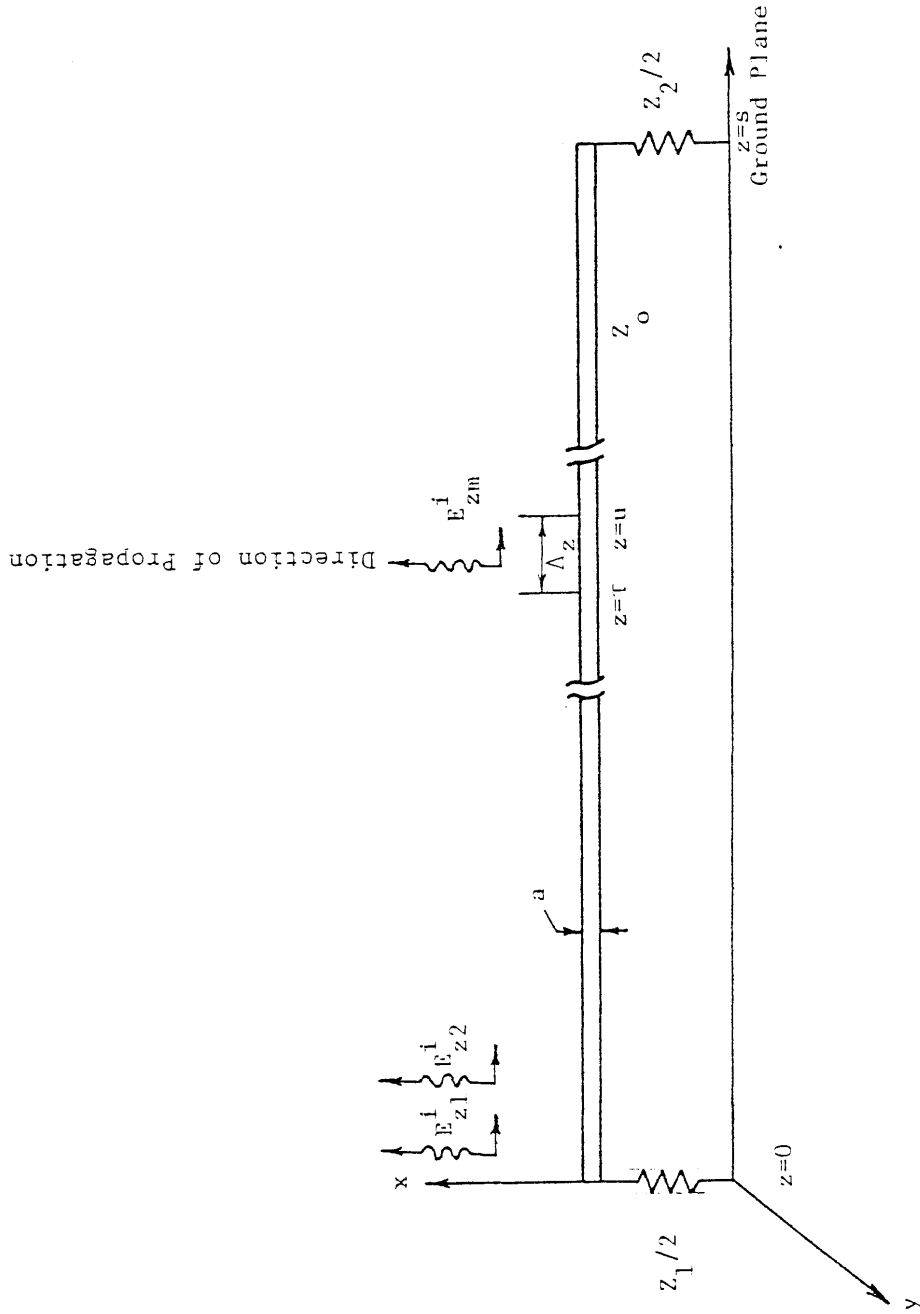

Figure D-2. Transmission Line Having Its Disjoint Segments Illuminated by Uncorrelated Fields.

$I_m(z, \omega)$ represents the common mode current at any z along the length of the line, due to the illumination of the m th segment of the line.

The above equation (D-6) can be used to calculate the common mode current in the general case, when some or all of the n segments of the line may be illuminated by separate fields (Figure D.2). If transfer function T_m is defined as:

$$T_m = \left(\frac{I_m(z, \omega)}{E_{zm}^i} \right) \quad (D-7)$$

then

$$I^2(z, \omega) = T_1^2 [E_{z1}^i]^2 + T_2^2 [E_{z2}^i]^2 + \dots + T_m^2 [E_{zm}^i]^2 + \dots T_n^2 [E_{zn}^i]^2 \quad (D-8)$$

$I(z, \omega)$ is the total common mode current at any point z , along the line, due to the illumination of its segments by uniform fields $E_{z1}^i, E_{z2}^i \dots E_{zm}^i \dots E_{zn}^i$, etc., when some of the E_{zm}^i are nonzero.

APPENDIX E

TYPES OF DIGITAL TRANSMISSION SYSTEMS

E.1. Introduction

The purpose of this Appendix is to consider various systems for the transmission of digital data and their relative performances. Before beginning, however, consider the block diagram of a digital data transmission system, shown in Figure E.1. The focus of our attention will be on the portion of the system between the blocks labeled encoder and decoder. In order to gain a better perspective of the overall problem of digital data transmission we will briefly discuss the operations performed by the blocks shown as dashed lines.

While many sources result in message signals which are inherently digital, such as teletypewriter and computer signals, it is often advantageous to represent analog signals in digital form (referred to as analog-to-digital conversion) for transmission and then convert them back to analog form upon reception (referred to as digital-to-analog conversion). Pulse code modulation (PCM), is an example of a modulation technique which can be employed to transmit analog messages in digital form. The signal-to-noise ratio performance characteristics of a PCM system, show one advantage of this system to be the option of exchanging bandwidth for signal-to-noise ratio improvement [23,24,25].

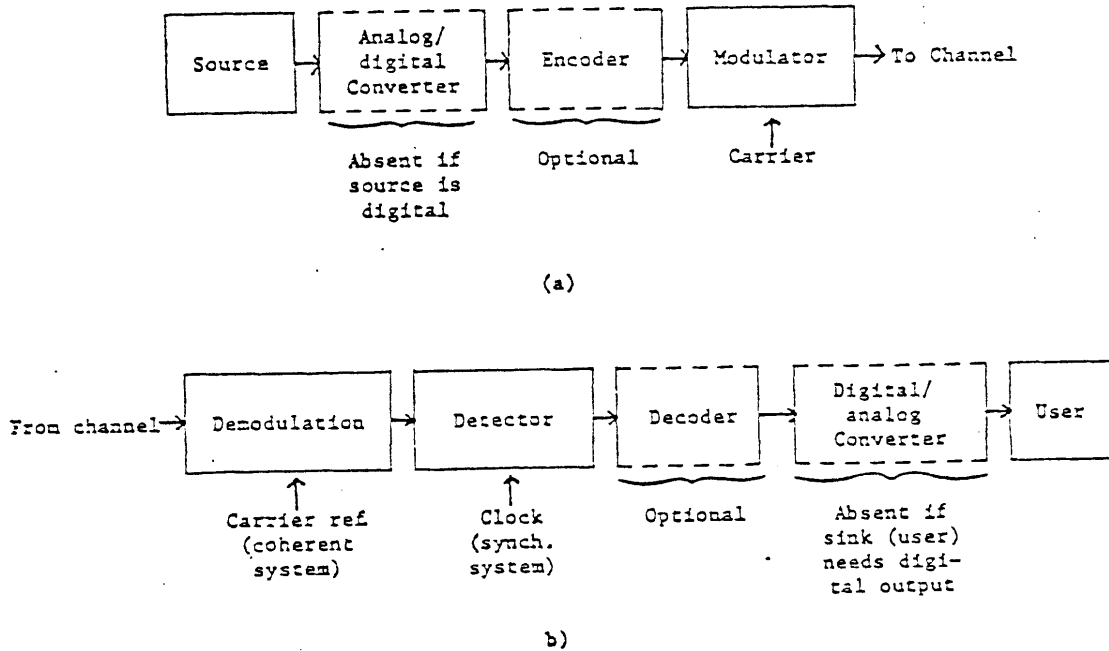

Figure E.1. Block Diagram of a Digital Data System.
(a) Transmitter. (b) Receiver.

The conversion of an analog signal to a digital signal is becoming much more common because once the signal has been accurately converted to a digital

value, the accuracy of the signal is very easy to maintain in transmission. Furthermore, the accuracy is determined by the number of bits in the digital signal.

Regardless of whether a source is purely digital or an analog source that has been converted to digital, it may be advantageous to add or remove redundant digits to the digital signal. Such procedures, referred to as coding, are performed by the encoder-decoder blocks of Figure E.1 and will be considered later [23,24,25].

With these preliminary considerations over, we now return to the basic system in Figure E.1 shown as the blocks with solid lines. If the digital signals at the modulator input take on one of only two possible values, the communication system is referred to as binary. If one of $M > 2$ possible values is available, it is referred to as M-ary. For long-distance transmission these digital baseband signals from the source may modulate a carrier before transmission. The result is referred to as amplitude-shift keying (ASK), phase-shift keying (PSK), or frequency-shift keying (FSK) if it is amplitude, phase, or frequency, respectively, which is varied in accordance with the baseband signal. More complex digital modulation schemes are also sometimes employed, but we will limit our attention to only these [23,24].

A digital system is referred to as coherent if a local reference is available for demodulation which is in phase with the transmitted carrier (with fixed phase shifts due to transmission delays accounted for). Otherwise, it is referred to as noncoherent. Likewise, if a periodic signal is available at the receiver that is in synchronism with the transmitted sequence of digital signals (referred to as a clock), the system is referred to as synchronous; if a signaling technique is employed where such a clock is unnecessary the system is called asynchronous. A teletypewriter system is an example of an asynchronous system.

The primary measure of system performance for digital data communication systems is the probability of error, p_e . In this Appendix expressions for p_e for various types of digital communication systems will be given. We are, of course, interested in receiver structures which give minimum p_e for given background conditions. Synchronous detection in a white Gaussian-noise background requires a correlation or a matched filter detector to give minimum p_e for fixed signal and noise conditions.

E.2. Baseband Transmission

Consider the binary digital-data communication system illustrated in Figure E.2 where the transmitted signal consists of a sequence of constant-amplitude pulses of either A or $-A$ units in amplitude and τ seconds in duration. A typical transmitted sequence is shown in Figure E.2(b). We may think of a positive pulse as representing a logic 1 and a negative pulse as representing a logic 0 from the data source. Each τ -second pulse is called a bit for a binary digit.

The channel is idealized as simply adding white Gaussian noise with double-sided power spectral density $1/2\eta_0$ to the signal. A typical received

signal is shown in Figure E.2(c). It is assumed that the starting and ending times of each pulse are known by the receiver. The problem of acquiring this information is referred to as synchronization.

The function of the receiver is to decide whether the transmitted signal was A or $-A$ during each bit period. A straightforward way of accomplishing this is to pass the signal plus noise through a lowpass predetection filter, sample its output at some time within each τ -second interval, and determine the sign of the sample. If the sample is greater than zero, the decision is made that $+A$ was transmitted. If the sample is less than zero, the decision is that $-A$ was transmitted. Since the starting and ending times of the pulses are known, a better procedure is to compare the area of the received signal-plus-noise waveform (data) with zero at the end of each signaling interval by integrating the received data over the τ -second signaling interval. Of course, a noise component is present at the output of the integrator, but, since the input noise has zero mean, it takes on positive and negative values with equal probability. Thus, the output noise component has mean zero. The proposed receiver structure and a typical waveform at the output of the integrator are shown in Figure E.3. For obvious reasons, this receiver is called an integrate-and-dump detector.

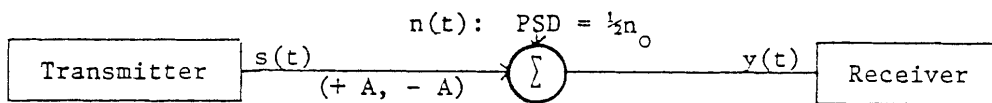

(a)

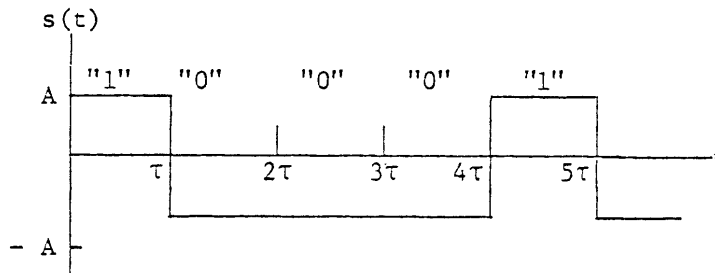

(b)

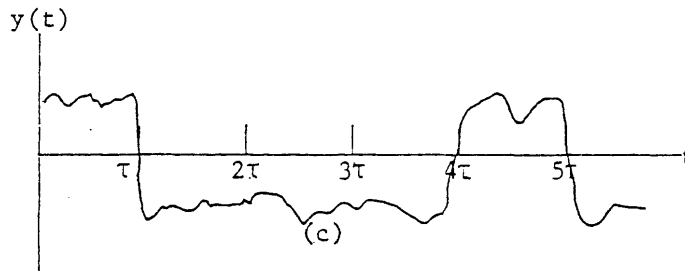

(c)

Figure E.2. System Model and Waveforms for Synchronous Baseband Digital Data Transmission. (a) Baseband Digital Data Communication System. (b) Typical Transmitted Sequence. (c) Received Sequence Plus Noise.

$$t = t_0 + \tau$$

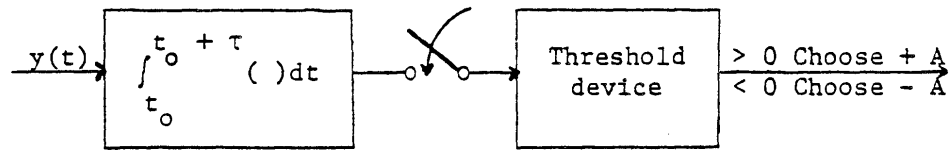

(a)

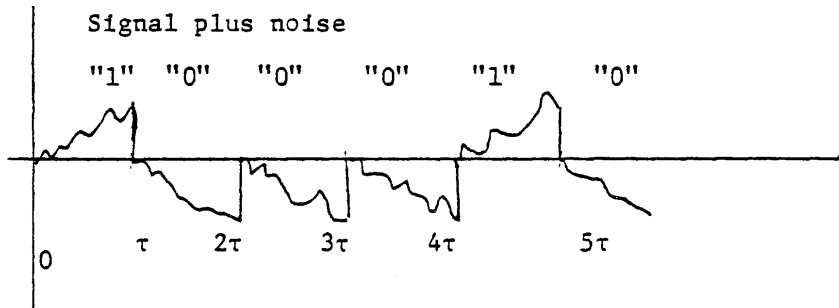

(b)

Figure E.3. Receiver Structure and Integrator Output.
 (a) Integrate-and-dump Receiver. (b) Output From Integrate-and-dump Detector.

The integrate-and-dump receiver can be shown to be optimum for a baseband system. The analysis for the probability of error p_e will not be given and can be found in a number of different texts. The baseband system is called unipolar if the two voltage levels are 0 and + A and bipolar if the two voltage levels are +A and -A. The probability of error is given in Table E.1, where S represents the signal power, η the power density spectrum of the noise, N the total noise power, and τ the pulse width; and B the bandwidth of the communication system.

E.3. Digital Modulation Systems

The use of direct digital transmissions is limited to low frequencies by the switching speeds available. In communication systems for various reasons, the digital signals are modulated on carrier signal before transmission. The three basic forms of digital modulation, are known as amplitude-shift keying (ASK), frequency-shift keying (FSK), and phase-shift keying (PSK). The modulation methods will briefly be examined by their probability-of-error advantage. Although digital systems using more than two signaling states are sometimes used, most systems used are binary and the emphasis is on binary systems.

E.3.1 Amplitude-Shift Keying (ASK)

In amplitude-shift keying, the amplitude of a high-frequency carrier signal is switched between two or more values in response to the digital input.

For the binary case, the usual choice is on-off keying (sometimes abbreviated as OOK). The resultant amplitude-modulated waveform consists of pulses, called marks, representing binary 1, and spaces representing binary 0. An ASK waveform is shown in Figure E.4 for a given code. The minimum bandwidth for an ASK signal can be shown to be doubled over a baseband system [23].

The ASK waveform for one pulse (i.e., a binary 1) can be written as:

$$f(t) = \begin{cases} A \sin \omega_c t & 0 < t < \tau \\ 0 & \text{otherwise} \end{cases}$$

The function of the receiver is to determine if a pulse was transmitted or not. The two most common methods of detection are coherent and envelope detection. The probability of error is less with coherent than envelope detection, however the latter is much cheaper to implement. The probability of error for coherent detection is

$$p_e = 1/2 \operatorname{erfc} \sqrt{S/N}$$

and envelope detection is [23,24,25]

$$p_e = \frac{1}{2} \left[1 + \frac{1}{\sqrt{4\pi S/N}} \right] e^{-S/N}$$

E.3.2. Frequency-Shift Keying (FSK)

In frequency keying, the instantaneous frequency of the carrier signal is switched between two (or more) values in response to the digital code. Figure E.4 shows an idealized FSK signal. This suggests that one can consider the FSK waveform as composed of two ASK waveforms of differing carrier frequencies. Thus to convey either of the binary symbols, we have a choice of the two waveforms:

$$f_1(t) = \begin{cases} A \sin m\omega_o t & 0 < t < \tau \\ 0 & \text{elsewhere} \end{cases}$$

$$f_2(t) = \begin{cases} A \sin n\omega_o t & 0 < t < \tau \\ 0 & \text{elsewhere} \end{cases}$$

The receiver must determine in this case which of the two frequencies was transmitted. Coherent detection may be used or two bandpass filters each tuned to the two separate frequencies and a comparator which samples the output of both filters determines if a "0" or "1" was transmitted. The coherent detector produces a probability of error

$$p_e = 1/2 \operatorname{erfc} \sqrt{S/N}$$

while the two filter detectors give

$$p_e = 1/2 e^{-S/N}$$

The coherent detector gives a better probability of error, however the two filter method is much cheaper to implement [23,24,25].

E.3.3. Phase Shift Keying

In phase shift keying, the phase of the carrier signal is switched between two (or more) values in response to the digital code. For the binary case a 180° phase shift is a convenient choice because it simplifies the modulator design and hence is often used. The PSK signal can be written as

$$f_1(t) = A \sin \omega_c t$$

$$f_2(t) = -A \sin \omega_c t$$

where $f_1(t)$ corresponds to logic "1" and $f_2(t)$ corresponds to logic "0" or vice versa. An example of PSK signal is given in Figure E.4.

The only type of detector for a PSK signal must of necessity be a coherent type, since the information is contained in the phase of the waveform. The probability of error is

$$p_e = 1/2 \operatorname{erfc} \sqrt{2S/N}$$

The complete tabulation of each p_e for the different systems is given in Table E.1. There are other more sophisticated modulation systems with improved performance, but they are seldom seen in the mine environment and will not be examined.

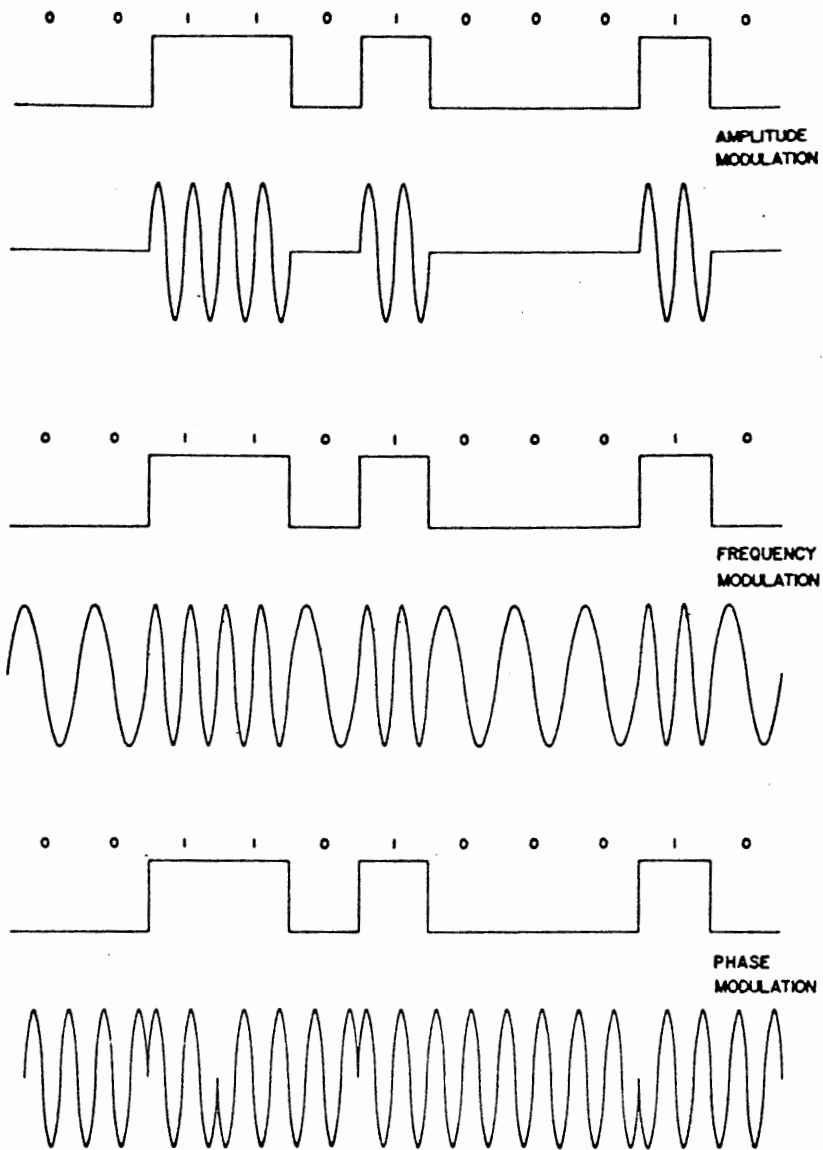

Figure E.4. Modulation Techniques

PROBABILITY OF ERROR

DEMODULATION TECHNIQUE

Baseband

$p_e = \frac{1}{2} \operatorname{erfc} \sqrt{\frac{A^2 \tau}{8\eta}} = \frac{1}{2} \operatorname{erfc} \sqrt{\frac{S}{4N}}$	Unipolar-Nonoptimum
$p_e = \frac{1}{2} \operatorname{erfc} \sqrt{\frac{A^2 \tau}{2\eta}} = \frac{1}{2} \operatorname{erfc} \sqrt{\frac{S}{2N}}$	Bipolar-Nonoptimum
$p_e = \frac{1}{2} \operatorname{erfc} \sqrt{\frac{A^2 \tau}{4\eta}} = \frac{1}{2} \operatorname{erfc} \sqrt{\frac{S}{2N}}$	Unipolar-Optimum
$p_e = \frac{1}{2} \operatorname{erfc} \sqrt{\frac{A^2 \tau}{\eta}} = \frac{1}{2} \operatorname{erfc} \sqrt{\frac{S}{N}}$	Bipolar-Optimum

ASK(OOK)

$p_e = \frac{1}{2} \operatorname{erfc} \sqrt{\frac{A^2 \tau}{8\eta}} = \frac{1}{2} \operatorname{erfc} \sqrt{\frac{S}{N}}$	Coherent
$p_e = \frac{1}{2} \left[1 + \frac{1}{\sqrt{2\eta} \left(\frac{A^2 \tau}{4\eta} \right)} \right] e^{-\frac{A^2 \tau}{8\eta}} = \frac{1}{2} \left[1 + \frac{1}{\sqrt{4\pi S/N}} \right] e^{-S/N}$	Noncoherent

FSK

$p_e = \frac{1}{2} \operatorname{erfc} \sqrt{\frac{A^2 \tau}{4\eta}} = \frac{1}{2} \operatorname{erfc} \sqrt{\frac{S}{N}}$	Coherent
$p_e = \frac{1}{2} e^{-\frac{A^2 \tau}{4\eta}} = \frac{1}{2} e^{-S/N}$	Noncoherent

PSK

$$p_e = \frac{1}{2} \operatorname{erfc} \sqrt{\frac{A^2 \tau}{2\eta}} = \frac{1}{2} \operatorname{erfc} \sqrt{\frac{2S}{N}}$$

Notation

$N = \eta B$, η = power density spectrum, B = Bandwidth, N = Noise power
 τ = signal interval, A = Level of signal

$$\operatorname{erfc}(x) = \frac{2}{\sqrt{\pi}} \int_x^{\infty} e^{-\sigma^2} d\sigma$$

Table E.1. Probability of Error For Various Communication Systems

APPENDIX F

ERROR DETECTION TECHNIQUES

F.1. Introduction

A number of different techniques for error detection are used to provide added protection for transmitted data. The hardware is sometimes called an encoder at the transmitter which adds redundant information and a decoder at the receiver to detect transmission errors. The most common technique is to add one extra parity bit which has the capability of detecting single bit errors. This system is used in the Powers-Conspec Communication System. The addition of a parity bit is a special case of the BCH Codes which will be treated in detail.

The most extensive and powerful codes (with few exceptions) for random error detection and/or correction are the Bose-Chaudhuri-Hocquenghem (BCH) codes. These codes are very easy to implement for encoding at the source and for error detection at the destination.

BCH codes as well as other codes such as Finite Projective Geometry codes (PG codes) and Euclidean Geometry codes (EG codes) are cyclic codes. PG and EG codes need more redundancy than BCH codes to provide the same random error detection and/or correction capabilities. PG and EG codes are easier to implement for random error correction at the receiver than BCH codes. However, only error detection hardware and codes will be considered.

In system design, if a cyclic code of suitable natural length or suitable number of information digits cannot be found, it may be desirable to shorten a cyclic code to meet the requirements. The same number of information and total bits are eliminated and the resultant code is called a shortened cyclic code. A shortened cyclic code has the same error detecting capability as the code from which it is derived [28-31]. The CRC-CCITT, CRC-16 and CRC-12 are in most cases shortened cyclic codes. Furthermore, they may be classified as shortened BCH cyclic codes in most cases.

F.2. Notation

It is assumed that anyone reading this is familiar with associating messages with coefficients of polynomials, and modulo two arithmetic involved in manipulating these polynomials. Otherwise, the following references are helpful [28-31]. It is helpful to define certain symbols and polynomials. (These definitions are consistent with the literature.)

k = number of binary digits (bits) in the message before encoding (sometimes called the number of information symbols).

n = number of binary digits (bits) in the encoded message.

$n-k$ = number of check digits (bits).

b = length of a burst of errors.

$M(x)$ = Message polynomial (of degree $k-1$).

$G(x)$ = Generator polynomial (of degree $n-k$).

$R(x)$ = Remainder on dividing $x^{n-k}M(x)$ by $G(x)$. $R(x)$ is of degree less than $n-k$.

$T(x)$ = Transmitted or encoded polynomial $T(x) = x^{n-k}M(x) + R(x) = G(x)Q(x)$.

$E(x)$ = Error polynomial (represents errors in transmission.)

$H(x)$ = Received encoded message polynomial $H(x) = T(x) + E(x)$.

$|F(x)|$ = Number of non-zero coefficients in $F(x)$.

F.3. Principles of Error Detection

An encoded received message containing errors can be represented by

$$H(x) = T(x) + E(x)$$

where $T(x)$ is the transmitted message and $E(x)$ is a polynomial which has a non-zero term (coefficient) in each erroneous position. Because the addition is modulo two, $H(x) = T(x) + E(x)$ is the true encoded message with the erroneous positions changed.

If the received message $H(x)$ is not divisible by $G(x)$, then clearly an error has occurred and retransmission is requested. If, on the other hand, $H(x)$ is divisible by $G(x)$, then $H(x)$ is a code polynomial and we must accept it as the one which was transmitted, even though errors may have occurred. Since $T(x) = G(x)Q(x)$, $H(x)$ is divisible by $G(x)$ if and only if $E(x)$ is not evenly divisible by $G(x)$. To insure an effective check, the generator polynomial $G(x)$ must be chosen such that error patterns $E(x)$ which occur the most often will not be divisible by $G(x)$. For detection of random errors this is most effectively done by insuring all error patterns $E(x)$ with $d-1$ or less non-zero coefficients are not divisible by $G(x)$. (This is the same as insuring all pairs of encoded polynomials differ in d or more coefficients or are of distance d apart).

F.4. Error Calculations

BCH and other cyclic and shortened cyclic codes can be designed to detect all random error patterns with the number of errors in each pattern being 1,2, etc., up to a selectable number of errors $d-1$. Therefore, an error pattern $E(x)$ will only be undetected if d or more errors occur (i.e., number of non-zero coefficients is d or more in $E(x)$). It is assumed that synchronism is maintained between the sending and receiving units in all calculations of error probabilities.

To determine the probability of undetected errors in a random channel (sometimes called a binary symmetric channel) it is necessary to define some terms. Let p = probability of a transmitted bit is received in error,

n = number of bits transmitted, and m = number of bits in error. The probability of a given error pattern of m bits in n bits ($0 \leq m \leq n$) is

$$P[E(x) = e^m(x)] = p^m(1-p)^{n-m}$$

where $e^m(x)$ is a polynomial with a m non-zero coefficients [28,29]. The total number of error patterns with a m non-zero coefficients is

$$\binom{n}{m} = \frac{n!}{m!(n-m)!}$$

which is commonly called the binomial coefficient. Thus,

$$P[|E(x)| = m] = \binom{n}{m} p^m(1-p)^{n-m}$$

where $|E(x)|$ represents the number of non-zero coefficients in $E(x)$, (i.e., the number of errors in the received message.) Therefore, to determine the probability of an undetected error, the probability of all error patterns with d or more errors are added to give

$$P(\text{undetected error}) = P(|E(x)| \geq d) = \sum_{m=d}^n \binom{n}{m} p^m(1-p)^{n-m}$$

It must be understood that not all error patterns with d or more errors will be undetected. In certain cases $G(x)$ can be constructed such that all error patterns with an odd number ($>d$) of errors can be detected. Then

$$P(\text{undetected error}) = P(|E(x)| = d, d_2, \dots, n) = \sum_{\substack{m=d \\ m \text{ even}}}^n \binom{n}{m} p^m(1-p)^{n-m}$$

The BCH Codes are determined by their generator polynomial which are products of primitive polynomials that have $\alpha^1, \alpha^2, \dots, \alpha^{d-1}$ as roots [28-31]. Fortunately, tables exist for finding these polynomials. The generator polynomial for a number of protocols and various cases has been tabulated. Some protocols also call the BCH code a cyclic redundancy code (CRC). The maximum length of the BCH Codes is $2^{n-k-1} - 1$ bits. If this length is exceeded, then the number of random errors detected will be less than the given values in Table F.1. The special case of parity checking can be represented by a special generator polynomial $G(x) = x + 1$. This error detection scheme is rather poor because not much data protection is given. Table F.1 also includes this case.

F.5. Burst Error Detection

A burst is defined as an error pattern in which the errors tend to occur in groups. The burst is defined by a length b in which the first and last bits are in error and the $b-2$ bits between the end bits may or may not be in error. The burst errors usually come from large transients such as switching, lightning etc. Any burst of length $b \leq n - k$ is detected with a generator

polynomial of degree $n - k$. The fraction of bursts of length $b > n - k$ that are undetected is [28-31].

$$\frac{1}{2^{n-k}} \text{ if } b > n - k + 1$$

and

$$\frac{1}{2^{n-k-1}} \text{ if } b = n - k + 1$$

Therefore, if $G(x) = x^{16} + x^{15} + x^2 + 1$ then all bursts of length 16 or less are detected. This information is also given in Table F.1.

Generator Polynomial	Error Detection Capability			Percent Detected Over Maximum Length Burst	Protocol Used
	Maximum Number of Random Errors Detected	Maximum Length Burst Which is Always Detected			
$G(x) = x + 1$	1	1		50%	Teletypes
$G(x) = x^8 + x^7 + x^5 + x^4 + x + 1$	3	8		99.61%	Control Applications
$G(x) = x^{12} + x^{11} + x^3 + x^2 + x + 1$	3	12		99.975%	IBM Bisync
$G(x) = x^{16} + x^{12} + x^5 + 1$	3	16		99.9985%	CCITT (Used Outside USA Mostly)
$G(x) = x^{16} + x^{15} + x^2 + 1$	3	16		99.9985%	DDCMP Protocol
$G(x) = x^{16} + x^{12} + x^5 + 1$	3	16		99.9985%	SDLC Protocol

Table F.1. Some Common BCH Codes

APPENDIX G

DATA COMMUNICATION PROTOCOLS

G.1. Introduction

The great majority of contemporary data communications applications involve electronic machines as the sources and/or sinks for information being transmitted. The industrial and mine communication and/or control applications are also becoming very sophisticated. Therefore, it is necessary that standard procedures and conventions govern the following:

1. Message blocking and format organization
2. Acknowledgment signalling and error control
3. Terminal access to line
4. Character synchronization between sources and sinks

These procedures are called throughout the industry as communication line formats, conventions, line protocols, or line disciplines. Regardless of the descriptive term used, their objective is to provide for the systematic, unambiguous, orderly, reliable and generally automatic use of the communication links [36,37].

The two most common new generation protocols are Digital Equipment Corporation's Digital Data Communications Message Protocol (DDCMP) and International Business Machine's Synchronous Data Link Control (SDLC). These two will be covered in detail because most new equipment uses one of these.

G.2. Digital Data Communications Message Protocol--DDCMP

DDCMP is designed to operate over clocked (synchronized) full- or half-duplex channels, switched or direct links, point-to-point or multi-point networks, and serial or parallel transmission facilities. Further, it will accommodate both synchronous and serial start-stop (asynchronous) modes. DDCMP is capable of controlling message transfers over standard existing hardware and can be implemented on many operating systems [37].

The format of a DDCMP transmission block is shown in Figure G.1. The only control character used in DDCMP is the first character in a message. It is used to distinguish between data, control, and bootstrap messages. SOH, ENQ and DLE are used, respectively.

The header is required. It contains the count of 8-bit quantities (bytes) in the information field, some control flags, a response field for positive acknowledgment of received messages, a message sequence number (modulo 256), and an address. The latter field is mainly used for addressing tributary stations in multipoint configurations. The header is verified by having its

own CRC. The information field is of variable length (up to 16,383 bytes) and it is followed by a 16 bits containing a CRC-16 calculated remainder.

DDCMP employs a rigorous set of rules for establishing, maintaining, and terminating a communications sequence. However, because it provides for simultaneous two-way transmission, its procedure is too extensive to cover in this appendix. The procedure outlined in Figure G.2 only touches upon its simplest but least efficient method and from a unidirectional point of view. The same procedure can be occurring in the opposite direction in full-duplex operation.

SYN	SYN	SOH	COUNT 14 BITS	FLAG 2 BITS	RESPONSE 8 BITS	SEQUENCE 3 BITS	ADDRESS 3 BITS	CRC 1 16 BITS	INFORMATION ANY NUMBER OF 8-BIT CHARACTERS	CRC 2 16-BITS
-----	-----	-----	------------------	----------------	--------------------	--------------------	-------------------	------------------	---	------------------

Figure G.1--DDCMP Message Format

DDCMP uses CRC-16 for detecting transmission errors. When an error occurs, DDCMP sends a separate negative acknowledgment (NAK) message. DDCMP does not require an acknowledgment message for all messages. The number in the response field of a normal header or in either the special NAK or positive acknowledgment (ACK) message specifies the sequence number of the last good message received. For example, if messages 4,5, and 6 have been received since the last time an acknowledgment was sent and message 6 is bad, the NAK message specifies number 5 which says "message 4 and 5 are good and 6 is bad." When DDCMP operates in the full-duplex mode, the line does not have to be turned around. The NAK is simply added to the sequence of messages for the transmitter.

When a sequence error occurs in DDCMP, the receiving station does not respond to the message. The transmitting station detects from the response field of the messages it receives (or via timeout) that the receiving station is still looking for a certain message and sends it again. For example, if the next message the receiver expects to see is 5 and it receives 6, it will not change the response field of its data message which contains a 4. This says "I accept all messages up through message 4 and I'm still looking for message 5."

DDCMP uses the ASCII control characters SOH (Start of Header) ENQ (Enquiry), and DLE (Data Link Escape) to distinguish between types of messages. The remainder of the message (including the header) is transparent. This means the data in the information field is encoded by some higher-level protocol according to its design standard for information interchange.

DDCMP achieves transparency by use of a count field in the header. The header is of fixed length. The count in the header determines the length of the information field which can be up to 16,383 bytes. To validate the header and count field, it is followed by a 16-bit CRC-16 field; all header characters are included in the CRC calculation. Once validated, the count is used

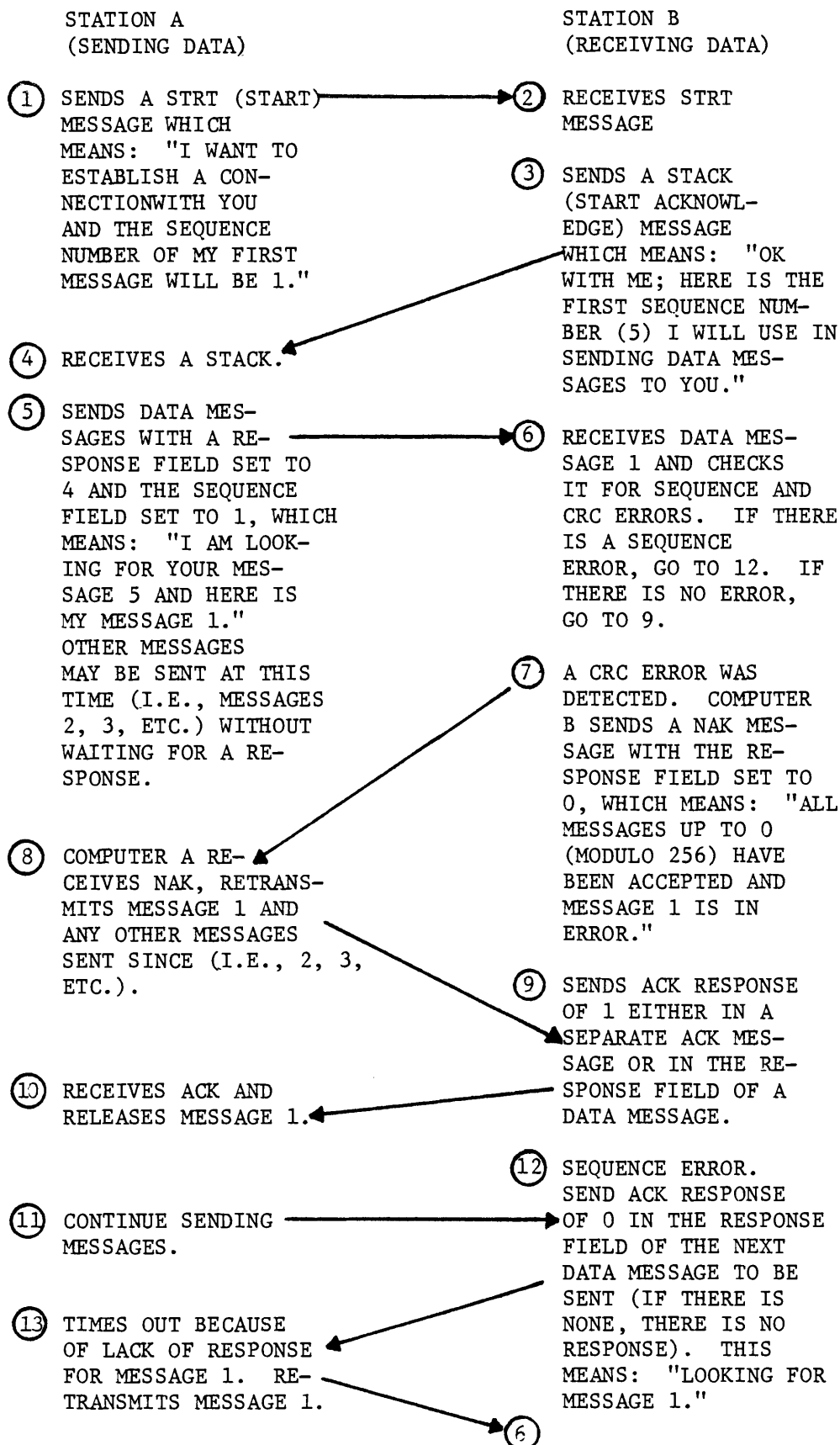

Figure G.2--DDCMP Simple Handshaking Procedure (One Direction)

to receive the data and locate the second CRC-16 which is calculated on the data field.

DDCMP uses either full-duplex or half-duplex circuits to their fullest extent. Both modes of operation are defined in a part of the protocol. In the full-duplex mode, it operates like two dependent one-way channels, each containing its own data-stream. The only dependency are the acknowledgments which must be sent in the data stream in the opposite direction. To reduce the response overhead, separate ACK messages are unnecessary. They are simply placed in the response field of the next message for the opposite direction. If several messages are received correctly before its transmitter is able to send a message (because the previous message was a long one), all of them can be acknowledged by one response. Only when a transmission error, occurs or if traffic in the opposite direction is light (no data message to send) is it necessary to send a special NAK or ACK message, respectively.

In summary, DDCMP line utilization features include:

1. The ability to run on full or half-duplex transmission facilities.
2. The ability to run on many existing hardware interfaces.
3. The ability to support point-to-point and multipoint lines.
4. Transmission mode independence (synchronous, asynchronous, or parallel).
5. No separate ACK's when traffic is heavy.
6. Multiple acknowledgements per ACK (up to 255 messages in one acknowledgment).

DDCMP achieves synchronization through the use of the two ASCII SYN characters preceding the SOH, ENQ, or DLE. It is not necessary to synchronize between messages as long as no gaps exist. This feature helps reduce the control overhead because each SYN takes 8-bit times. Character synchronization is unnecessary when DDCMP is used for serial asynchronous and parallel channels.

DDCMP can be used for serial synchronous, serial asynchronous, and parallel facilities. This is total facility transparency.

G.3. Synchronous Data Link Control--SDLC

IBM's SDLC (Synchronous Data Link Control) was announced in 1973 and operational on products in 1974. Unlike DDCMP, it is bit-oriented rather than character-oriented. It is designed for full and half-duplex operation [36].

The format of SDLC is shown in Figure G.3. The only control character used in SDLC is the flag character which has the bit pattern 01111110. There is a fixed length 24-bit header, a variable length information field, and a fixed-length 24-bit trailer. In addition, the transparency technique

(explained below) can increase the size of any of these fields except for the two 8-bit flags that frame the message.

	FLAG 8 BITS	ADDRESS 8 BITS	CONTROL 8 BITS	INFORMATION ANY NUMBER OF BITS	FRAME CHECK SEQUENCE 16 BITS	FLAG 8 BITS	
--	----------------	-------------------	-------------------	--------------------------------------	------------------------------------	----------------	--

SYMBOL DENOTES
START & END OF FRAME

Figure G.3--SDLC Message Format

Like DDCMP, SDLC may operate on full-duplex facilities and uses an efficient procedure for data exchange. The example in Figure G.4 presents only a one-directional transfer of data in a full-duplex operation. Equivalent operation in the other direction also occurs because it is symmetrical.

SDLC uses CRC-CCITT to detect transmission errors. It handles CRC with an inversion technique that differs from methods used by character-oriented protocols. This technique improves the range of undetected errors in the domain of possibilities. Like DDCMP, SDLC has a response field (3 bits in the control field) and separate ACK and NAK messages. Unlike DDCMP, SDLC does not NAK transmission errors. The way it handles them is best explained by example: Station B receives messages 2, 3 and 4 from Station A and message 4 is bad. Station B in its next data message for Station A, responds with message 4 which says: "I have received and accepted messages 2 and 3 and I am still looking for message 4". Station A, knowing it has sent message 4, must wait a period of time to see if it will be acknowledged (timeout) before it sends the message again.

Unlike DDCMP, SDLC responds to sequence errors with a NAK message (a less frequent occurrence than transmission errors). The response is similar to DDCMP's handling of transmission errors in that the NAK acknowledges the messages received in correct sequence condition, i.e., "received 4, 5 correctly and looking for 6" when it receives 7 instead.

SDLC is not concerned with information exchange codes. The only control character is the flag and it has a fixed pattern (01111110) regardless of the exchange code used by the system. Like DDCMP, a higher-level protocol defines the information exchange code used to transfer meaningful data.

SDLC is a bit-oriented protocol and only has to be sure that a flag character bit pattern anywhere between frames does not arrive at the receiver.

The technique used by SDLC for achieving transparency may be referred to as "bit stuffing." SDLC uses a character at each end of the message called a "flag." The flag's bit sequence is 01111110. The only control characters are the flag characters. To ensure that a flag character does not appear in the data portion of the message, a zero (0) bit is inserted whenever five one (1)

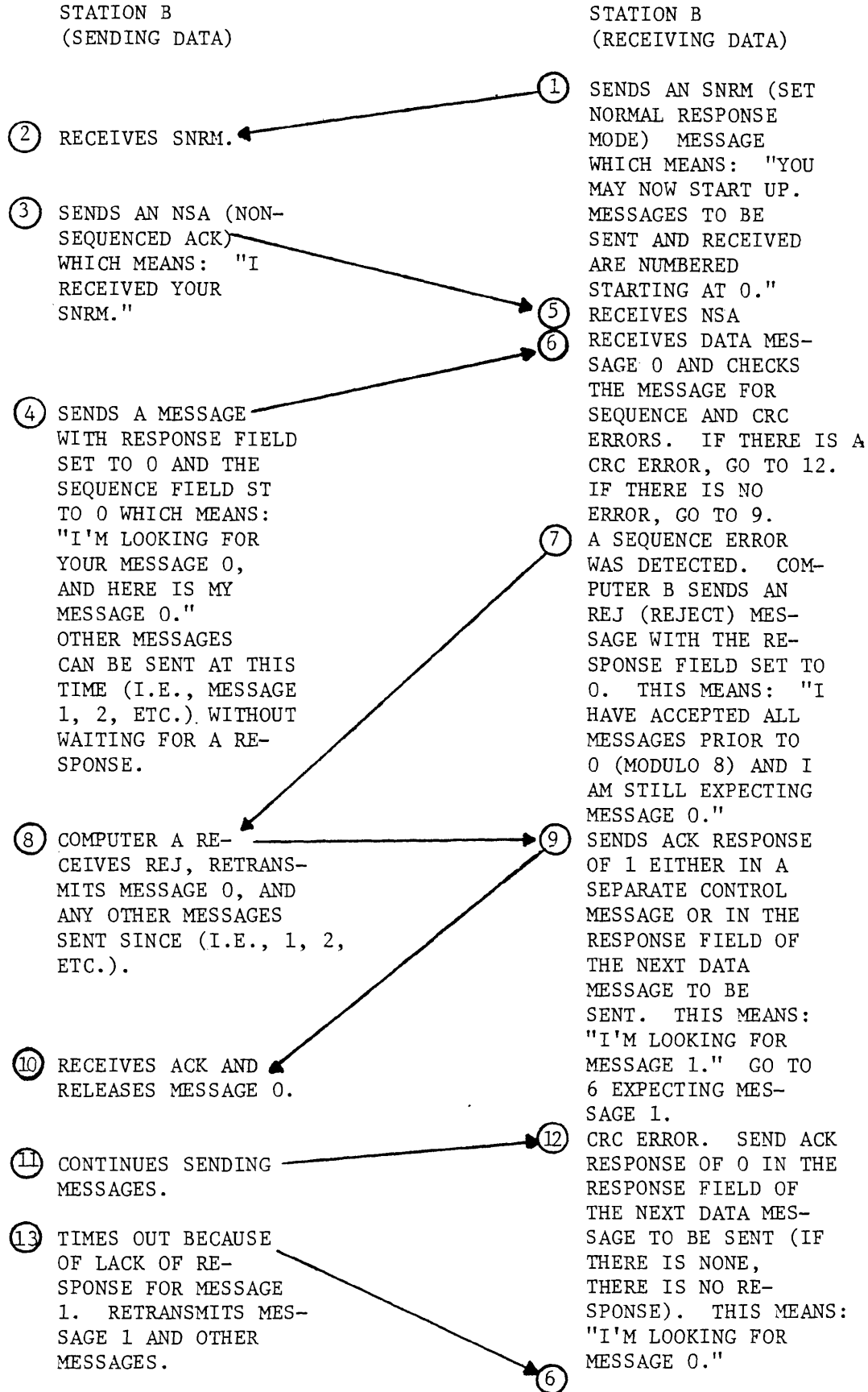

Figure G.4--SDLC Simple Handshaking Procedure (One Direction)

bits appear in a row. Thus, a 01111110 bit pattern meant to be data would appear in the data stream as 011111010, or 9 bits. The receiver also counts bits, and if it detects five one's in a row followed by a zero bit, it removes the zero bit. If it was a one bit, it is a legitimate flag and the end of message has been received.

SDLC uses transmission facilities with similar efficiency to DDCMP because of the following features:

1. The ability to transmit on full or half-duplex facilities.
2. Low control character overhead (flag, header, and check bits total 6 characters). DDCMP uses 10 characters [28].
3. No "character stuffing"; SDLC uses "bit stuffing". In contrast, DDCMP's transparency overhead is fixed because it used a count method.
4. No separate ACK messages are necessary.
5. Multiple acknowledgments per ACK (up to 7 messages).
6. The ability to support point-to-point and multipoint lines.

SDLC synchronizes on the flag characters between messages. No SYN characters are required.

Because of the "bit stuffing" requirement of SDLC, it cannot be used for serial asynchronous or parallel facilities. Asynchronous characters are fixed length and "bit stuffing" would destroy them. On parallel connections, a separate wire(s) would be needed for the stuff bit(s). SDLC is designed for efficient use of high speed serial synchronous full-duplex facilities.

G.4. Other Protocols

A number of national and international standards organizations have been cooperating over the past years to produce standard data communication protocols. These organizations include the American National Standards Institute (ANSI) and the International Standards Organization (ISO).

The cooperative efforts of these organizations have resulted in the development of a variety of standard data communications control procedures and codes. Typical of these developments are the Advanced Data Communication Control Procedures (ADCCP) developed by ANSI, and the High-Level Data Link Controls (HDLC) developed by ISO. These protocols differ slightly from SDLC.

A number of manufactures of communication equipment for control and monitoring have developed relatively specialized protocols for their own equipment. Rarely can more than one manufactures equipment be tied into the communication system. Conspec Protocol supports asynchronous transmission, uses a parity bit for every 8 bits of data, and sends two characters during each transmission. This protocol is obviously not as comprehensive as DDCMP or SDLC.

APPENDIX H

KEY WORDS

Asynchronous transmission

Transmission in which time intervals between transmitted characters may be of unequal length. Transmission is controlled by start and stop elements at the beginning and end of each character.

Baud

A unit of signalling speed equal to the number of discrete conditions or signal events per second. Baud is the same as bits per second if each signal event represents one bit.

Bit transfer rate

The number of bits transferred per unit time, usually expressed in Bits Per Second.

Bit

In binary notation either of the characters 0 or 1.

Block character check (BCC)

The result of a transmission verification algorithm accumulated over a transmission block, and normally appended at the end.

Carrier

A continuous frequency capable of being modulated or impressed with a signal.

Channel

Part of a communications system that connects a message source to a message sink.

Coaxial cable

Cable consisting of a conductor completely surrounding another conductor and separated from it by a solid dielectric or air with spacing insulators.

Cyclic Redundancy Check (CRC)

An error detection scheme in which the check character is generated by taking the remainder after dividing all the serialized bits in a block of data by a predetermined polynomial.

Data Link

An assembly of terminal installations and interconnecting circuits operating according to a particular method that permits information to be exchanged between terminal installations.

Field

An area under the influence of an electromagnetic or electrostatic charge.

Frequency Shift Keying (FSK)

A modulation scheme in which the instantaneous frequency may take on only two possible values.

Modulation

The process of superimposing a signal on a carrier wave so that it may be transmitted.

Noise

Any undesirable disturbances in a communication system.

Parallel transmission

Method of data transfer in which all bits of a character or byte are transmitted simultaneously either over separate communication lines or on different carrier frequencies on the same communication line.

Phase modulation

A method of transmission whereby the angle of phase of the carrier wave is varied in accordance with the signal.

Protocol

A formal set of conventions governing the format and relative timing of message exchange between two communicating processes.

Reverse channel

A channel used for transmission of supervisory or error-control signals. The direction of flow of these signals is in the direction opposite to that in which information is being transmitted.

Serial transmission

A method of transmission in which each bit of information is sent sequentially on a single channel rather than simultaneously.

Signal to Noise Ratio

Relative power of the signal to the noise in a channel, usually measured in decibels.

Shielded cable

A cable surrounded by a metallic sheath to decrease the effects of stray electric fields.

Synchronous

The maintenance of one operation in step with another.

Twisted Pair

Two insulated wires that are wrapped around each other.

REFERENCES

1. Bensema, W.D., M. Kanda, J.W. Adams. "Electromagnetic Noise in Robena No. 4 Coal Mine," NBS Technical Note 654, April 1974.
2. Adams, J.W., W.D. Bensema, M. Kanda. "Electromagnetic Noise in Grace Hardrock Mine," NBSIR 74-388, June 1974.
3. Kanda, M., J.W. Adams, W.D. Bensema. "Electromagnetic Noise in McElroy Coal Mine," NBSIR 74-389, June 1974.
4. Bensema, W.D., J.W. Adams, M. Kanda. "Electromagnetic Noise in Itmann Coal Mine," NBSIR 74-390, June 1974.
5. Adams, J.W., M. Kanda, W.D. Bensema. "Electromagnetic Noise in Lucky Friday Metal Mine," NBSIR 74-391, June 1974.
6. Kanda, M. "Time and Amplitude Statistics for Electromagnetic Noise in Mines," IEEE Transactions on Electromagnetic Compatibility, Vol. EMC-17, No. 3, pp. 122-129, August 1975.
7. Crary, J.H. "Determination of the Electromagnetic Environment in Coal Mines," NTIS Report (Bureau of Mines Report 35-72) PB-213 204, March 1972.
8. Aldridge, M.D. "Analysis of Communication Systems in Coal Mines," NTIS Report (Bureau of Mines Report 72-73) PB-225 862, May 1973.
9. "Coal Mine Rescue and Survival System," Final Report, Vol. II, Communications/Location Subsystem, Westinghouse Electric Corporation, September 1971.
10. USBM, Underground Mine Communications, IC-8744, 1977.
11. Cory, T.S. "Propagation of EM Signals in Underground Mines," H0366028, Final Report, September 1977.
12. Cory, T.S. "Measurement and Characterization of Noise on Twisted Pair Telephone Lines in Coal Mines" Compendium of Working Memoranda 1-8, prepared for United States Department of the Interior Bureau of Mines, May 1979.
13. "Research and Development Contract for Coal Mine Communication System" Final Report, Collins Radio Company, PB 244 896/AS, November 1974.
14. Cowdell, R.B. "New Dimensions in Shielding," IEEE Transactions on Electromagnetic Compatibility, Vol. EMC-10, No. 1, pp. 158-167, March, 1968.
15. Transmission Systems for Communications, Bell Telephone Laboratories, Winston-Salem, North Carolina, Western Electric, Inc., Technical Publications, 1970.

16. Bates, C.P. and G.T. Hawley. "A Model for Currents and Voltages Induced Within Long Transmission Cables by an Electromagnetic Wave," IEEE Transactions on Electromagnetic Compatibility, Vol. EMC-13, No. 4, pp. 18-31, November 1971.
17. Vance, E.F. "Shielding Effectiveness of Braided-Wire Shields," IEEE Transactions on Electromagnetic Compatibility, Vol. EMC-17, No. 2, pp. 71-77, May 1975.
18. Harrison, C.W. "The Response of a Terminated Two Wire Line Suspended in Air Above a Semi-Infinite Dissipative Medium Excited by a Plane-Wave RF Field Generated in Free Space," IEEE Transactions on Electromagnetic Compatibility, Vol. EMC-11, No. 4, pp. 149-151, November 1969.
19. Smith, A.A., Jr. Coupling of External Electromagnetic Fields to Transmission Lines, A. Wiley-Interscience, New York, New York, 1977.
20. Vance, E.F., Coupling to Shielded Cables, A Wiley-Interscience Publication, New York, New York, 1978.
21. Conspec Data Sheets on Senturian System, Conspec, 44 Martin Ross Avenue, Downsview, Ontario M3J248.
22. "Modular Mine Monitoring and Control System" Phase II Final Report, West Virginia University, Contract No. H0144114-Mine Wide Test of the WVU Monitoring Concept, December 1979.
23. Ziemer, R.E. and W.H. Trantner. Principles of Communication Systems, Modulation, and Noise, Houghton-Mifflin, Boston, Massachusetts, 1976.
24. Lindsey, W.C. and M.K. Simon. Telecommunications Systems Engineering, Prentice-Hall, Englewood Cliffs, New Jersey, 1973.
25. Peebles, P.Z. Jr., Communication System Principles, Addison-Wesley, Reading, Massachusetts, 1976.
26. Transmission Systems for Communications, Bell Telephone Laboratories, Winston-Salem, North Carolina, Western Electric, Inc., Technical Publications, 1970.
27. Cory, T.S. "Predicted Differential Mode Noise Levels on a Shielded Phone Line in a DC Mine" working Memorandum prepared for United States Department of the Interior, Bureau of Mines, May, 1980.
28. Brown, D.T. and W.W. Peterson, "Cyclic Codes for Error Detection," Proc. IRE, 49, pp. 228-235, January 1961.
29. Peterson, W.W., "Error-Correcting Codes," The M.I.T. Press, Cambridge, Massachusetts, and John Wiley, New York, 1961.
30. Peterson, W.W. and E.J. Weldon, Jr., "Error-Correcting Codes," Second Edition, The M.I.T. Press, Cambridge, Massachusetts, 1970.
31. Lin, Shu, "An Introduction to Error-Correcting Codes," PRENTICE-Hall, Inc., Englewood Cliffs, New Jersey, 1970.
32. Shenfeld, S., "Coupling Impedance of Cylindrical Tubes," IEEE Trans. on EMC, Vol. EMC-14, No. 1, pp. 10-16, February, 1972.

33. Miller, D.A. and P.P. Toullos, "Penetration of Coaxial Cables by Transient Fields," 1968 IEEE EMC Symposium Record, pp. 414-423.
34. Whitman, R.M., "Cable Shielding Performance and CRV Response," IEEE Trans. on EMC, Vol. EMC-15, No. 4, pp. 180-187, November, 1973.
35. McDowell, C.N. and M.J. Bernstein, "Surface Transfer Impedance Measurements on Subminiature Coaxial Cables," IEEE Trans. on EMC, Vol. EMC-15, No. 4, pp. 188-190, November, 1973.
36. Doll, D.R., Data Communication-Facilities Networks, and Systems Design, Wiley-Interscience Publication, John Wiley and Sons, New York, New York, 1978.
37. Introduction to Minicomputer Networks, Digital Equipment Corporation, Maynard, Massachusetts, 1974.