

**RI 9616**

**REPORT OF INVESTIGATIONS/1995**

# **Assessment of Airborne Dust Generated From Small Truck-Mounted Rock Drills**

**By J. A. Organiscak and S. J. Page**

**UNITED STATES DEPARTMENT OF THE INTERIOR**



**UNITED STATES BUREAU OF MINES**



***U.S. Department of the Interior  
Mission Statement***

As the Nation's principal conservation agency, the Department of the Interior has responsibility for most of our nationally-owned public lands and natural resources. This includes fostering sound use of our land and water resources; protecting our fish, wildlife, and biological diversity; preserving the environmental and cultural values of our national parks and historical places; and providing for the enjoyment of life through outdoor recreation. The Department assesses our energy and mineral resources and works to ensure that their development is in the best interests of all our people by encouraging stewardship and citizen participation in their care. The Department also has a major responsibility for American Indian reservation communities and for people who live in island territories under U.S. administration.

**Report of Investigations 9616**

# **Assessment of Airborne Dust Generated From Small Truck-Mounted Rock Drills**

**By J. A. Organiscak and S. J. Page**

**UNITED STATES DEPARTMENT OF THE INTERIOR  
Bruce Babbitt, Secretary**

**BUREAU OF MINES  
Rhea Lydia Graham, Director**

International Standard Serial Number  
ISSN 1066-5552

## CONTENTS

	<i>Page</i>
Abstract .....	1
Introduction .....	2
Dust survey of small rock drills .....	2
Sampling strategy and precision .....	2
Dust emission sources .....	5
Improved dust controls for small truck-mounted drills .....	7
Abatement dust controls .....	7
Wet dust suppression of Rotoclone exhaust .....	7
Improved dust capture at the drill deck shroud .....	8
Shrouded Rotoclone hopper discharge .....	9
Wet drilling .....	9
Dust avoidance techniques .....	10
Extended rotoclone exhaust port .....	10
Worker positioning .....	10
Conclusions .....	11
References .....	11

## ILLUSTRATIONS

1. Plan view of dust sampling strategy .....	3
2. Plan view of cyclone sampling orientation with respect to wind .....	4
3. Plot of regression models for air velocity effects on dust sampler orientation .....	4
4. Drill with dust emissions around the drill deck shroud and the exhaust of the Rotoclone dust collector .....	5
5. Dust cloud generated during Rotoclone dust-collector dumping .....	6
6. Graph of instantaneous dust levels during a typical dust-collector dumping .....	6
7. Visible dust in the Rotoclone exhaust of a coal mine drill .....	8
8. No visible dust in the exhaust from a drill equipped with the water-trickle system .....	8
9. An improved drill deck shroud arrangement .....	9
10. No visible dust with the shrouded collector dumping operation and field installation of Rotoclone exhaust extender .....	10

## TABLES

1. Dust sampling data from small highwall drills .....	3
2. Drill area dust sample averages .....	6
3. Dust control evaluation data for small highwall drills .....	7

## UNIT OF MEASURE ABBREVIATIONS USED IN THIS REPORT

### Metric Units

L	liter	mg	milligram
Lpm	liter per minute	mg/m <sup>3</sup>	milligram per cubic meter
m	meter	mm	millimeter
m/s	meter per second		

### U.S. Customary Units

fpm	foot per minute	min	minute
ft	feet	mph	mile per hour
gal	gallon	pct	percent
gpm	gallon per minute	RPM	revolution per minute
h	hour	s	second
in	inch		

Reference to specific products does not imply endorsement by the U.S. Bureau of Mines.

# ASSESSMENT OF AIRBORNE DUST GENERATED FROM SMALL TRUCK-MOUNTED ROCK DRILLS

By J. A. Organiscak<sup>1</sup> and S. J. Page<sup>2</sup>

---

## ABSTRACT

Dust surveys were conducted around small truck-mounted rock drills operating at surface coal mines to assess their airborne respirable dust generation and in-service dust control methods. Of four out of seven drills sampled, respirable dust concentrations measured around the drill deck ranged from 8.68 to 95.15 mg/m<sup>3</sup> with concentrations ranging from 1.37 to 2.69 mg/m<sup>3</sup> at distances 12.2 to 30.5 m downwind of these drills. The other drills had noticeably lower respirable dust concentrations measured around the drill deck at or below 1.30 mg/m<sup>3</sup>. Rotoclone-type dry dust collectors were commonly used with dust being emitted from around the drill deck shroud, collector exhaust, and collector fines dumping. Wind speed and direction was also a factor in the dust concentrations measured on the bench.

Dust control modifications were made to three rock drills to reduce their airborne dust emissions. Dust controls tested included water injection into the Rotoclone exhaust, Rotoclone exhaust extension, improved sealing of drilling deck shroud, shrouding the Rotoclone hopper dump process, and wet drilling. These control techniques showed noticeable improvement in dust concentrations measured around the drills. Finally, repositioning the drill operator showed that operator dust exposure can be improved by avoiding the dust cloud around the drill.

---

<sup>1</sup>Mining engineer.

<sup>2</sup>Research physicist.

Pittsburgh Research Center, U.S. Bureau of Mines, Pittsburgh PA.

## INTRODUCTION

Silica dust continues to be an ongoing health concern in the coal mining industry. Exposure to crystalline silica dust can cause serious or fatal respiratory disease. The three types of silicosis, depending on the airborne concentration of crystalline silica and length of exposure are: *chronic*, occurring after 10 or more years of exposure to relatively low concentrations; *accelerated*, occurring 5 to 10 years of exposure to high concentrations; and *acute*, occurring after a few weeks to 5 years exposure to extremely high concentrations.

The Mine Safety and Health Administration's (MSHA) permissible dust standard for coal mine workers is a shift average of 2.0 mg of airborne respirable coal mine dust per cubic meter of air (2.0 mg/m<sup>3</sup> as defined by the Mining Research Establishment (MRE) Criteria)(1).<sup>3</sup> If the airborne respirable dust (ARD) sample contains more than 5 pct quartz (crystalline silica), the dust standard is reduced to the quotient of 10 divided by the percentage of quartz in the dust, limiting the respirable crystalline silica exposure to a maximum of 0.1 mg/m<sup>3</sup> (MRE equivalent). These respirable dust standards are expected to significantly reduce a worker's risk to occupational lung disease throughout an average life expectancy. The Occupational Safety and Health Administration (OSHA) also reduces their dust standards for crystalline silica in mineral dusts in nonmining occupations (2).

In the late 1980's, surface mine highwall drill operators accounted for about 20 pct of the more stringent dust standards issued by MSHA in the coal industry, and this occupation had the lowest average reduced standard at 0.8 mg/m<sup>3</sup> (3). Many of the highwall drill operators were on reduced standards below 0.5 mg/m<sup>3</sup>, indicating that this occupation had silica exposure risks. U.S. Bureau of Mines (USBM) research on surface mine overburden drills in the late 1980's showed that dust controls typically used on large track-mounted surface drills are either a dry cyclone-filter type or a wet suppression system that injects small quantities of water into the bailing air. Both dry and wet dust collection systems were capable of achieving dust reductions of 95 pct, but the most

significant variable affecting the degree of dust control appeared to be operation of the systems (4). Dry dust collectors usually had emission problems with collector dumping and cleaning, and dust leakage around the drill deck. Wet drilling had problems with reduced bit life due to bearing degradation and bit wear from operating in an abrasive rock dust-slurry environment. To improve the effectiveness of these dust control systems, the USBM identified several concepts to rectify the problem areas identified with the existing systems (5). Dust control methods that improved the effectiveness of dry collection systems include a pin-type agglomerator for dumping the collector cuttings and an air ring seal to contain dust from escaping the drill deck. Water quantity guidelines and a water separator inside the bit stabilizer were found to improve dust capture and increase bit life for wet drilling systems. USBM research established that viable dust control technology is available to control dust on large track-mounted surface drills.

The National Institute for Occupational Safety and Health (NIOSH) has recently issued an NIOSH Alert: Request for Assistance in Preventing Silicosis and Deaths in Rock Drillers (6). In this report, NIOSH documented cases of acute, accelerated, and chronic silicosis in surface mine drill operators. The age of these workers start as low as 25 with cases of workers in their 30's. Since many of these personnel worked on small rotary rock drills, NIOSH concluded that inadequate dust controls are being used on many small mobile rock drills and requested that the USBM investigate these types of rock drills.

The USBM dust research program, in response to the NIOSH Alert and request for investigation, recently studied small surface mine drills to assess their dust generation hazards and the effect of dust control technologies implemented. Most of these drills were truck-mounted and used Rotoclone dry-dust collection systems. This report describes the initial dust source surveys and assessment of dust control enhancements for small mobile rock drills.

## DUST SURVEY OF SMALL ROCK DRILLS

### SAMPLING STRATEGY AND PRECISION

The USBM conducted dust sampling around seven truck-mounted rock drills operating at small surface coal mines. The dust sampling strategy encompassed sampling in the visible dust clouds around the

drill deck and on the surface mine bench downstream of the drill (see figure 1). Dust samplers were placed on tripods so they could be positioned 0.6 to 1.5 m (2 to 5 ft) off the ground. Each tripod had a real-time aerosol monitor, a RAM-1, (with a data logger) and two personal respirable dust gravimetric samplers. Initially two sampling stations (tripods) were positioned on each side of the drill deck and one sampling station on the bench. Depending on the wind

<sup>3</sup>Italic numbers in parentheses refer to items in the list of references at the end of this report.



Figure 1

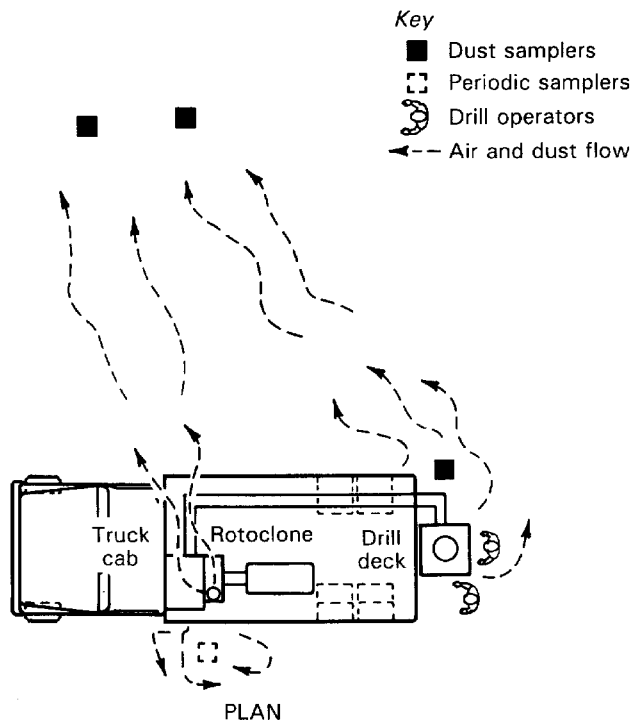

Plan view of dust sampling strategy.

direction, only one sampling station around the drill deck was exposed to the dust cloud, so only one sampling station was positioned on the immediate downstream side of the drill deck with two sampling stations positioned downstream 12.2 to 30.5 m (40 to 100 ft) of the drill on the mine bench. Sampling stations were moved with the drill, and sampling times ranged from 2 to 4 h. The bench sampling stations were positioned at varying distances from the drill to accommodate the bench terrain and sample the Rotoclone exhaust dust cloud descending onto the bench. Momentary RAM sampling was also conducted in the dust cloud generated by dumping the cuttings from the dust collector every few holes drilled. *All the dust concentrations measured are not worker dust exposures, but indicate the respirable dust concentrations in the visible dust clouds around the drill. Also, all airborne respirable dust concentrations measured by personal dust samplers (Atomic Energy Commission (AEC) Criteria (2)) in this study are not reported as MRE equivalent concentrations. A MRE equivalent concentration is a personal sampler concentration multiplied by a constant factor prescribed by the Secretary of Labor (1).*

The results of the dust surveys are shown in table 1. Initial dust sampling results from the first two drills sampled (A and B) showed a large variation between dust concentrations measured by the two personal dust samplers on each tripod (see table 1). Sampling at these two drills was conducted under high gusty wind conditions with the personal sampler cyclones (respirable dust classifiers) placed on each side of the RAM not necessarily oriented (cyclone inlets)

Table 1.—Dust sampling data from small highwall drills

Drill	Sample location	Sampler orientation						Air velocity	
		Random		Parallel		Perpendicular			
		Dust conc., mg/m <sup>3</sup>	Coef. of var.	Dust conc., mg/m <sup>3</sup>	Coef. of var.	Dust conc., mg/m <sup>3</sup>	Coef. of var.		
A ..	Downstream drill on bench ..	0.33 ± 0.48	1.07	ND	ND	ND	ND	Est. @ >8.9 m/s (20 mph)	
	Left side of drill .....	1.03 ± 0.67	0.67						
	Right side of drill .....	1.58 ± 1.32	1.32						
B ..	Downstream drill on bench ..	1.79 ± 3.18	1.28	ND	ND	ND	ND	Est. @ >8.9 m/s (20 mph)	
	Downstream drill on bench ..	0.18 ± 0.09	0.36						
	Left side of drill .....	0.54 ± 0.31	0.42						
C ..	Downstream drill on bench ..	ND	ND	<b>2.86</b>	<b>±0.17</b>	<b>0.04</b>	<b>2.26</b>	<b>±0.03</b>	4.1-7.6 m/s (800-1,500 fpm)
	Downstream drill on bench ..			2.98	±0.65	0.16	2.69	±0.01	
	Next to drill shroud .....			<b>11.44</b>	<b>±1.30</b>	<b>0.08</b>	<b>8.30</b>	<b>±1.22</b>	
D ..	Downstream drill on bench ..	ND	ND	1.35	±0.09	0.05	1.78	±0.37	1.5-2.0 m/s (290-400 fpm)
	Downstream drill on bench ..			2.21	±0.59	0.19	2.02	±0.76	
	Next to drill shroud .....			<b>118.03</b>	<b>±30.89</b>	<b>0.19</b>	<b>72.28</b>	<b>±6.01</b>	
E ..	Next to drill shroud .....	ND	ND	1.23	±0.29	0.17	ND	ND	1.5-2.0 m/s (290-400 fpm)
F ..	Downstream drill on bench ..	ND	ND	2.47			0.26		
	Downstream drill on bench ..			1.47	±0.26	0.13	2.50	±1.31	
	Next to drill shroud .....			<b>13.44</b>	<b>±0.25</b>	<b>0.01</b>	<b>10.09</b>	<b>±0.25</b>	1.0-1.7 m/s (200-326 fpm)
G ..	Downstream drill on bench ..	ND	ND	0.90	±0.30	0.24	0.83	±0.05	
	Downstream drill on bench ..			3.02	±4.32	1.03	0.76	±0.10	
	Next to drill shroud .....			8.62	±0.84	0.07	8.74	±0.74	1.6-1.8 m/s (320-345 fpm)
	Average	0.91	0.85	<sup>1</sup> 14.07		<sup>1</sup> 0.20	9.38	0.15	

ND No data.

<sup>1</sup>Drill E not in average because sampler orientation comparisons were not made at this drill.

NOTE:—**Bold numbers** identify significant differences between dust concentrations measured with different sampler orientations.

in the same direction with the wind. The average coefficient of variation for these sampler pairs was 85 pct. When sampling drills C through G, two more personal samplers were added to each tripod, and a pair of cyclone inlets were oriented reasonably into the wind (parallel) and 90° (perpendicular) to the wind in an attempt to improve precision and identify a wind effect on sampler orientation (see figure 2). Several 1-min air velocity measurements were taken with a vane anemometer during dust sampling (reported in table 1). Results of this sampling modification showed that sampling error was notably reduced with consistent sampler orientation and four of the sampler pairs had significant differences (at the 95 pct confidence level) in dust concentrations measured with the different sampler orientations (shown in bold print in table 1). Nine out of the eleven sampler pairs had higher concentrations oriented into the wind. The average concentrations measured into the wind (parallel) was 14.07 mg/m<sup>3</sup> and perpendicular to the wind was 9.38 mg/m<sup>3</sup>. The average coefficient of variations for parallel and perpendicular orientation pairs were 20 and 15 pct, respectively. It must be noted that some inconsistencies or errors in the orientation study were introduced by some wind direction variations, but samplers were reasonably operated for a majority of the time in the indicated sampler orientations.

Regression analysis of the sampler inlet orientation data also indicates that the samples oriented into the wind tend to have higher concentrations, particularly at high dust levels. Regression analysis of the perpendicular sampler (X) and parallel sampler (Y) data showed the model  $Y_{\parallel} = X_{\perp}^{1.11}$  ( $R^2 = 0.99$ ) to be a good fit (see figure 3). Since one data point in this analysis is significantly higher than the other point and can notably influence the regression model, another regression analysis was conducted with the highest data point removed. This

Figure 2

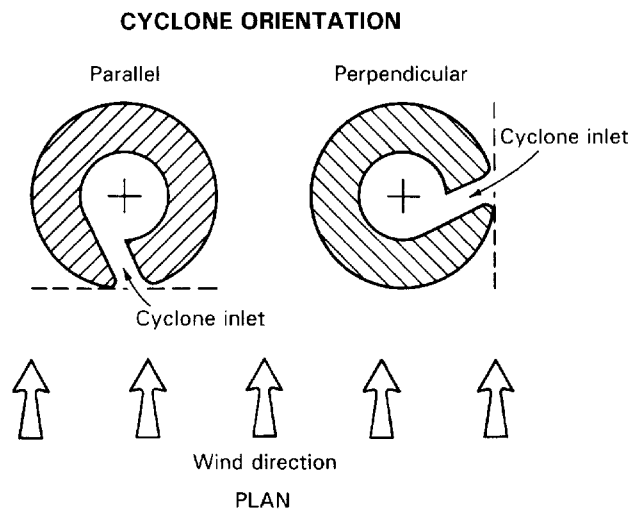

Plan view of cyclone sampling orientation with respect to wind.

analysis showed a similar good fit with a model of  $Y_{\parallel} = X_{\perp}^{1.09}$  ( $R^2 = 0.90$ ) (see figure 3). The fitted curve is shown with a dashed line up to 10 mg/m<sup>3</sup> and the dotted line is the model extrapolation above the regression data range. Also shown on figure 3 is the unity curve  $Y_{\parallel} = X_{\perp}$ , assuming equal dust concentrations for different sampler orientations. Both regression curves were found to be significantly different from the unity line (at a 95-pct confidence level) and these curves both bend toward the Y axis (parallel sampler), indicating that higher dust concentrations were measured with the parallel orientation. This sampling difference is noticeable at higher dust concentrations. However, smaller differences in dust concentrations for sampler orientations are predicted by both regression models at lower dust concentrations. For example, if the perpendicular oriented dust sampler measured 2.0 mg/m<sup>3</sup>, the regression models predict that the parallel concentrations would be between 2.1 and 2.2 mg/m<sup>3</sup> under the air velocity conditions measured in this study, 1.0 to 7.6 m/s (200 to 1,500 fpm).

Prior USBM research has shown that respirable dust concentrations can be affected by cyclone orientation (7). Cyclone orientation into the airstream showed 20 pct

Figure 3

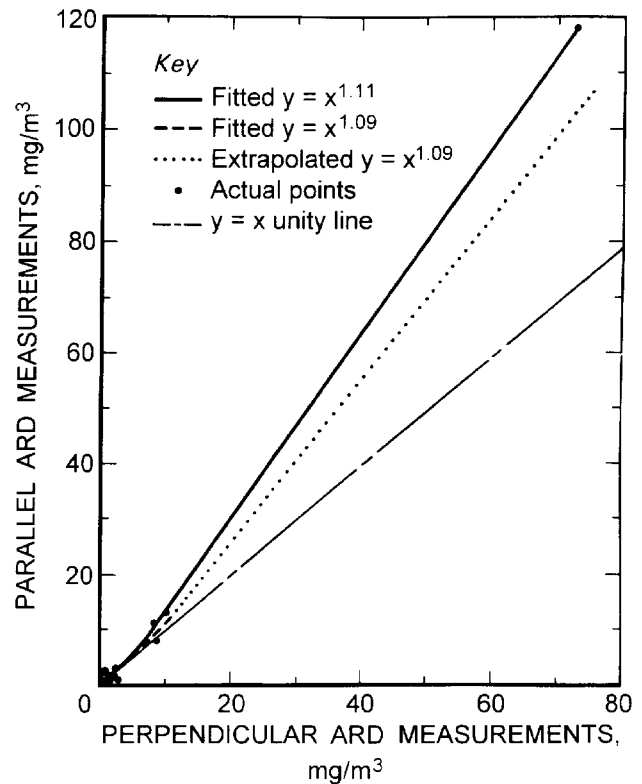

Plot of regression models for air velocity effects on dust sampler orientation.

over-sampling at air velocities of 6.1 m/s (1,200 fpm) and increased to over 30 pct at 10.2 m/s (2,000 fpm). Cyclone orientation perpendicular to the airstream showed 20 pct undersampling at air velocities as low as 2.0 m/s (400 fpm) and increased to 30 pct at 6.1 m/s (1,200 fpm) and 40 pct at 10.2 m/s (2,000 fpm). These results indicate that cyclone orientation sampling error, depending on air velocity, can produce either over sampling or under sampling when the cyclone orientations vary by 90°. Since most of the air velocities measured in the above study were under 6.1 m/s (1,200 fpm), the most influential effect was probably undersampling with the samplers oriented perpendicular to the wind. However, air velocities above 10.2 m/s (2,000 fpm) may impact lower dust concentration measurements as theorized from the poor sampling precision measured under high gusty wind conditions observed at drills A and B.

### DUST EMISSION SOURCES

The dust generated at these drills was a result of poor containment of the dust by the collector. These drills typically use a Rotoclone dust collector. This dust collector is basically a dry centrifugal fan separator, equipped with a pre-separator. The intake of the Rotoclone is ducted from the drill deck which is enclosed or shrouded with belting material. Although the Rotoclone is effective in removing total airborne dust material from the intake, it still discharges significant quantities of respirable dust to the atmosphere. The exhaust of the Rotoclone is usually directed vertically upwards with the intention that the

ambient wind on the drill bench will carry away the emitted dust. The dust cuttings removed by the collector are accumulated in hoppers and have to be manually dumped or emptied periodically. One of the seven drills studied (drill E) used a Donaldson filter-type dust collector instead of the Rotoclone that eliminated the dust emission source from its collector exhaust. This type of dust collector also had an automated dump port close to the bench surface, eliminating the dust cloud generated from emptying the collector cuttings.

The two primary and constant dust emission sources from the Rotoclone collector were from the drill deck shroud and the dust collector discharge exhaust. Figure 4 visibly shows these two emission sources when a drill is operating. Table 2 shows the average dust concentration and quartz content of all the samplers (oriented parallel and perpendicular to the wind) located around the shroud and on the drill bench for each drill sampled. As can be seen from this table, the highest dust concentrations measured were usually around the drilling deck with lower dust concentrations measured 12.2 m to 30.5 m (40 to 100 ft) away from the drill. Four of the seven drills had average dust concentrations greater than or equal to 8.68 mg/m<sup>3</sup> around the drill deck shroud. These drills usually had a shroud with gaps along the adjoining seams of each side or a large gap between the ground and shroud, allowing dust to escape the collector inlet. Also, some of the operators would leave one side of the shroud pulled up to shovel cuttings. Drills A, B, and E had well-constructed shrouds with smaller gaps, contributing to the lower dust concentrations measured around the drill deck ( $\leq 1.30$  mg/m<sup>3</sup>).

Figure 4

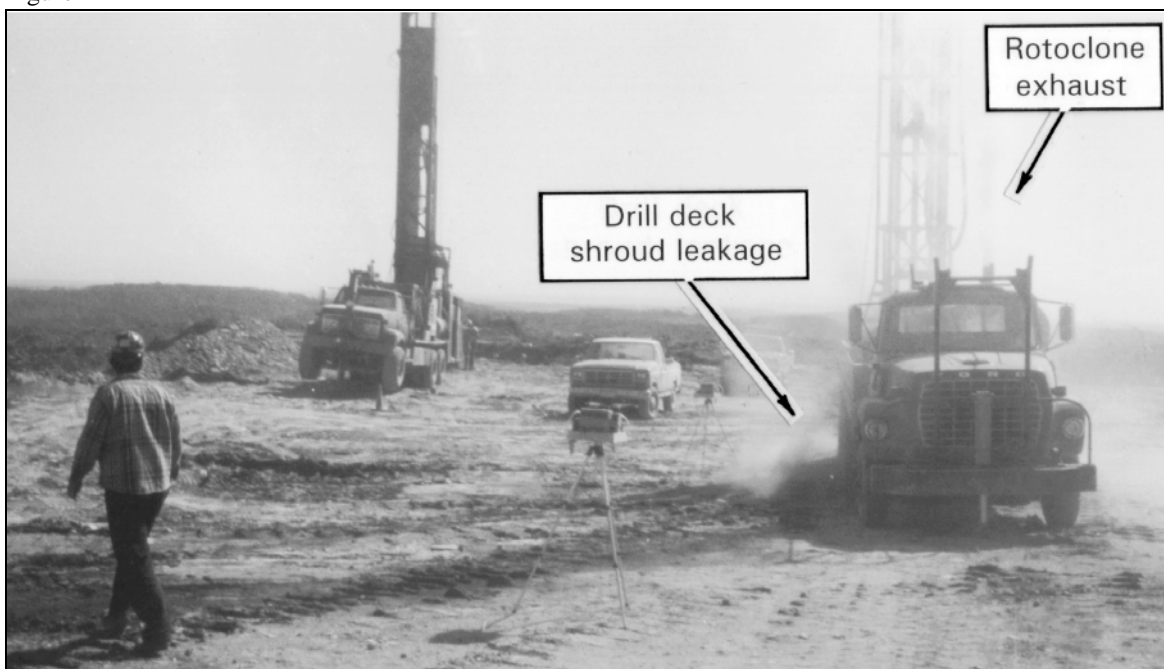

*Drill with dust emissions around the drill deck shroud and the exhaust of the Rotoclone dust collector.*

**Table 2.—Drill area dust sample averages**

Drill	Sampler location	Mean conc., mg/m <sup>3</sup>	Mean quartz, pct
A ..	Downstream drill on bench .	0.33	( <sup>1</sup> )
	Right side of drill . . . . .	1.30	( <sup>1</sup> )
B ..	Downstream drill on bench .	0.98	( <sup>1</sup> )
	Left side of drill . . . . .	0.54	( <sup>1</sup> )
C ..	Downstream drill on bench .	2.69	12.3
	Next to drill shroud . . . . .	9.87	10.4
D ..	Downstream drill on bench .	1.84	11.4
	Next to drill shroud . . . . .	95.15	13.7
E ..	Next to drill shroud . . . . .	1.23	8.1
F ..	Downstream drill on bench .	1.98	7.1
	Next to drill shroud . . . . .	11.76	5.3
G ..	Downstream drill on bench .	1.37	6.5
	Next to drill shroud . . . . .	8.68	6.9

<sup>1</sup>Not enough weight for quartz analysis.

The Rotoclone exhaust stream is directed vertically upwards above the drill so the wind will dilute and/or carry away the emitted dust. However, on small drill benches in the hilly terrain of the Appalachian Mountains, the wind commonly hugs the terrain, passing over the drill and swirling back onto the drill bench. The bench sampler locations downstream of the drill were positioned in the visible dust swirling from the Rotoclone exhaust back onto the bench, measuring its contribution to dust concentrations on the bench. These bench dust concentrations, 12.2 m to 30.5 m (40 to 100 ft) downstream of the drill, ranged

Figure 5



*Dust cloud generated during Rotoclone dust collector dumping.*

from 0.33 to 2.69 mg/m<sup>3</sup>, averaging 1.53 mg/m<sup>3</sup>. Although these dust concentrations are a lot lower than around some of the drill decks sampled, they are not insignificant when the quartz content of the dust is high. Quartz content or the dust clouds sampled at each drill were similar at the bench and drill deck location, indicating that the quartz content of the dust is similar regardless of where it is emitted by the drill. The measurable quartz content of all the dust clouds sampled in this study were between 5.3 to 13.7 pct, which would reduce the dust standard for mine workers exposed to these dust clouds to somewhere between 2.0 and 0.8 mg/m<sup>3</sup>.

A less frequent, although still significant, third source of dust is the dumping of the Rotoclone hopper(s). The hoppers retain the dust removed by the Rotoclone and must be periodically and manually emptied. This is accomplished by opening two trap doors and letting the material fall out to the ground, a distance of 0.9 to 1.2 m (3 to 4 ft). Impact of the material and subsequent dispersion by wind creates a substantial airborne dust problem. Figure 5 visibly shows the dust cloud that can be generated from emptying the Rotoclone hopper and figure 6 shows a graph of the typical respirable dust concentrations while emptying the dust collector. As can be seen in these two figures, the airborne dust concentrations are high but occur during short intervals (a few minutes) every couple of holes. Although the total portion of time exposed to this dust source is small, the high level of dust concentration generated can still influence dust exposure.

Figure 6

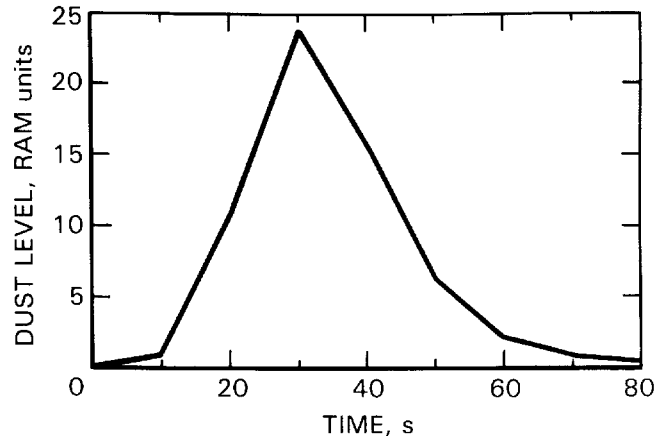

*Graph of instantaneous dust levels during a typical dust collector dumping.*

## IMPROVED DUST CONTROLS FOR SMALL TRUCK-MOUNTED DRILLS

Poor containment of the dust by the Rotoclone collector system was the most common problem associated with small truck-mounted rock drills. The USBM evaluated several drill modifications and operating practices to identify improved dust control techniques for these small truck-mounted rock drills. The dust control methods studied were either abatement or avoidance techniques. Abatement techniques contain or capture the dust before it becomes airborne in the worker's environment, avoidance techniques involve keeping the worker out of the dust cloud that is emitted.

Assessment of dust control techniques was conducted at three different drill operations. Some of these controls were studied individually and some were studied in combination. Dust sampling was conducted with RAM and gravimetric samplers mounted on a tripod, similar to the source identification study, except that three gravimetric samplers were oriented into or parallel to the airflow on the bench. Prior USBM research concluded that this sampler orientation is less susceptible to air velocity effects, especially under 10.2 m/s (2,000 fpm) air speeds. These samplers were placed downwind of the emission source before and after the modifications were made to the drill during the same operating shift. Again, these samplers were moved with the drill and commonly operated for 1 to 3.5 h of sampling during each test condition, and cannot be used for compliance purposes. Quartz analyses were conducted on the samples that contained enough weight for analysis.

### ABATEMENT DUST CONTROLS

Abatement dust control techniques that were studied included water injected (trickled) into the Rotoclone exhaust, improved dust capture at the drill deck shroud, shrouded Rotoclone hopper discharge, and wet drilling. These techniques were evaluated at two drilling sites on three different drills. Evaluation of each control technique was conducted on the same drilling bench during one operating shift, half of shift with the baseline condition(s) and the other half of the shift with controlled condition(s). Results of these field studies are shown in table 3.

#### Wet Dust Suppression of Rotoclone Exhaust

Wet suppression of the dust in the Rotoclone exhaust was conducted by injecting small quantities of water into an extended Rotoclone discharge duct on drill H. The Rotoclone discharge port was rotated so that the discharge is horizontal or downward. Approximately 6.1 m (20 ft) of flexible tubing that is approximately the same diameter as the discharge port, was coupled to the port. Although not tested, a shorter length may possibly work as well. The duct was mounted at a downward-sloping angle along the side of the drill so that the exit remains above the ground approximately 0.3 m (1 ft).

Table 3.—Dust control evaluation data for small highwall drills

Drill	Dust control method	Sampler location	Controls OFF		Controls ON		Efficiency	
			Dust conc., mg/m <sup>3</sup>	Quartz content, pct	Dust conc., mg/m <sup>3</sup>	Quartz content, pct	Dust conc., mg/m <sup>3</sup>	Quartz content, pct
H . . . .	Wet dust suppression of Rotoclone exhaust.	Next to Rotoclone exhaust.	27.20	21.1	2.14	18.5	-92.1	-12.3
I . . . .	Extended Rotoclone exhaust and closed drill shroud.	Downstream drill on bench.	1.22	9.9	0.46	7.8	-62.3	-21.1
	Extended Rotoclone exhaust and closed drill shroud.	Next to drill shroud.	2.34	10.0	0.86	11.0	-63.2	10.2
	Rotoclone discharge hopper enclosed.	Next to discharge hopper.	25.42	( <sup>1</sup> )	4.94	( <sup>1</sup> )	-80.6	( <sup>1</sup> )
	Sampler location—on drill vs on operator.	Drill control panel and operator.	1.56	14.0	1.51	11.6	-3.2	-17.1
	Operator location—standing back from drill.	Next to and away from shroud.	1.51	11.6	0.47	( <sup>1</sup> )	-68.9	( <sup>1</sup> )
J . . . .	Wet drilling <sup>2</sup> . . . . .	Next to drill shroud.	1.18	12.1	0.84	10.1	-28.8	-16.8

<sup>1</sup>Not enough weight for quartz analysis.

<sup>2</sup>Efficiency is a comparison with drill I using all controls operating on the same drilling bench.

A water tank of approximately 378 L (100 gal) capacity was mounted at a location and elevation that is suitable for gravity-feeding a small amount of water into the Rotoclone discharge port. The drill operator using this system used an old truck fuel saddle tank. It is estimated that 378 L (100 gal) or less will be sufficient for 8 h of continuous drilling, using 0.76 Lpm (0.2 gpm) flowrate for most Rotoclone sizes typically used on small drills. Due to the low flowrate, the water from the tank was supplied through 6.35-mm (1/4-in) tubing. Any variety of fittings suitable can be mounted in the metal discharge port of the Rotoclone. It is recommended that two valves be used to control the water flow, one as a flow regulator and the second valve as the on/off control.

In tests to compare the effectiveness of the water trickle in reducing dust emissions from the Rotoclone discharge, tests were performed on the same drill bench with and without the use of water. The results of dust sampling approximately 3.0 m (10 ft) directly downwind of the Rotoclone discharge, showed 92 pct reduction of respirable dust and the elimination of all visible dust emissions. Analysis of the dust samples showed that the quartz content of the respirable samples decreased slightly from 21 pct quartz without using water to 18 pct quartz with the water trickle system (a negligible difference). Figures 7 and 8 show the effectiveness of the trickle system on eliminating visible emissions from the Rotoclone discharge. First-hand visual observation of the discharge while using water could not detect any emissions.

Operationally, it is critical not to use too much water to prevent clogging problems. Because of the wide range of

airflows that can be obtained on a given size of Rotoclone due to the RPM of operation, the amount of water used must be determined individually for each application. One simple guideline is to slowly increase the trickle flowrate until the visible emissions are significantly reduced. It will be found that as the duct interior becomes wetted, the dust reduction will improve with time.

Also, the down-sloping of the discharge duct is important to allow excess water to drain from the line. Actual extended operation of the system showed that some material agglomeration will occur within the first foot of duct length during an 8-h drilling period. However, this material is easily removed by disconnecting the duct from the Rotoclone exit. If the duct is connected with a standard hose clamp, cleaning can be performed in a few minutes.

### Improved Dust Capture at the Drill Deck Shroud

The existing drill deck shroud on the drill tested (drill I) was generally found to be in good condition. In order to simulate an inferior shroud, one lower corner of the front shroud flap was fixed to a chain and hooked in the "up" position for the duration of the test segment labeled "controls off". This practice was employed by the drillers occasionally so that they could shovel out some of the cuttings. However, during the "controls on" test segment the flap was immediately lowered after shoveling. Testing showed that reducing the leakage of the shroud area simply by maintaining a shroud in good condition reduced the dust emissions by approximately 63 pct. Leakage would still

Figure 7



*Visible dust in the Rotoclone exhaust of a coal mine drill.*

Figure 8



*No visible dust in the exhaust from a drill equipped with the water-trickle system.*

occur along the seams occasionally, resulting in the measured dust concentration of  $0.86 \text{ mg/m}^3$  during the "controls on" test. The changes in quartz content in the dust between the control condition was negligible (10 pct with open shroud, 11 pct with closed shroud).

Figure 9 shows a conceptual diagram of an improved shroud design that may provide significantly better sealing of the corner seams while maintaining the necessary flexibility. This design has not been tested nor has it been found to be previously used or described in the literature. However, it is the opinion of the authors that it may be a design suitable for reducing dust emissions from the shroud used on both dry and wet drilling operations.

Important to the testing of the shroud is the fact that prior to testing, the drill operator increased the operating speed of the Rotoclone close to the maximum recommended value of 3,000 RPM. According to the operator, the Rotoclone had been running significantly slower and the increased speed made a noticeable difference to dust capture in the shroud. This fact is important if many existing Rotoclones in operation are running slower in comparison, resulting in a preferential increase in the amount of dust escaping a shroud that is not in very good condition. Thus, maintaining good shroud condition is more important at slower collector operating speeds. Previous research on larger track-mounted rock drills show that as dust collector airflow to bailing airflow ratio increases from 2:1 to 8:1, the dust leakage from the shroud is significantly reduced (5). Therefore, increasing the speed of the Rotoclone should be advantageous to reducing dust leakage from the shroud. Since they are usually belt-driven with pulleys, it can either be

calculated to determine the speed of operation or measured directly with a strobe tachometer.

### Shrouded Rotoclone Hopper Discharge

Figure 10 shows a temporary installation of a shroud around the hopper discharge doors on drill I used for test purposes. The shroud consisted of brattice material and was mounted by large magnets for ease of installation and removal during testing. Two flaps were cut in the shroud to allow the operator access to the hopper doors for opening and closing. ARD concentrations were reduced by an average of 80 pct during the testing. Since gravimetric dust samples were collected over short periods of time (minutes) during the Rotoclone dumping, not enough weight was collected for quartz analysis. The sole reason for the measurement of any dust present while using the shroud was leakage at the open vertical seam in the shroud. Although leakage was minimized by overlapping the shroud ends after the wrap-around, it could not be eliminated. A more permanent installation would have a sealed seam and would certainly be expected to provide better control of the dust.

### Wet Drilling

During the testing of dust controls on drill I, another identical truck-mounted drill (drill J) operating on the same mining bench used water injection down-the-hole instead of a Rotoclone collector. This drill was also dust sampled downstream of the drill deck shroud, thereby providing identical test conditions for an ideal comparison between wet drilling and the modified

Figure 9

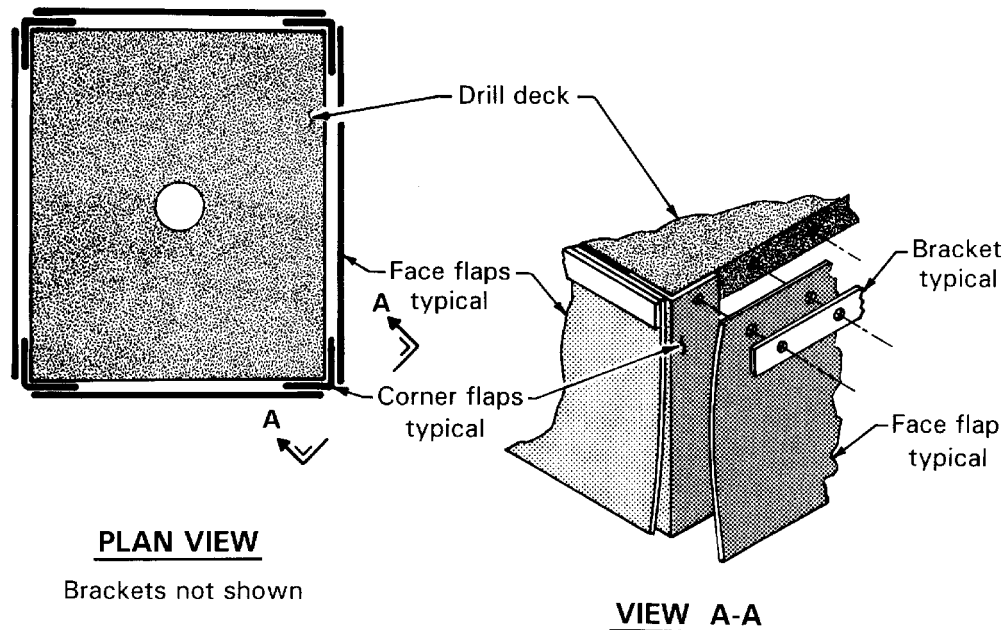

*An improved drill deck shroud arrangement.*

Rotoclone system. Compared to the Rotoclone collector with the multiple improvements discussed above, wet drilling was 29 pct better in reducing ARD levels in the immediate drill vicinity where the operator would typically be located. In addition, the dust emission problem of the Rotoclone exhaust was eliminated.

### DUST AVOIDANCE TECHNIQUES

Avoidance dust control techniques that were studied included extended Rotoclone exhaust port and worker positioning. These techniques were also evaluated at drill I, concurrently with the other controls being evaluated. Evaluation of each control technique was conducted on the same drilling bench during one operating shift, half of the shift with the baseline condition(s) and the other half of the shift with controlled condition(s). Results of these field studies are shown in table 3.

#### Extended Rotoclone Exhaust Port

The exhaust port of the Rotoclone was fitted with a 2.4 m (8 ft) vertical section of 1.52-mm (6-in) PVC pipe to test the effectiveness in lowering the dust concentrations on the drill

bench (figure 10). Testing was performed with and without this exhaust extension during the evaluation period. At a downwind distance of approximately 30.5 m (100 ft), the exhaust extension lowered ARD concentrations by an average of 62 pct. This reduction was visually observed to be due to the effect of discharging the visibly emitted dust higher in the air. Because of this, the air currents were not able to downdraft the dust significantly with the result that the dust remained airborne higher above bench level for a much longer distance. Although this technique does not "clean" the dust from the exhaust, it appears to significantly reduce dust levels on the drill bench and may possibly be suitable for use when other mine personnel are not located downwind of the drilling bench.

#### Worker Positioning

Dust sampling was conducted at several locations at various distances from the drilling deck of drill I to identify the significance of worker positioning around the drill deck during its operation. One set of samplers (three gravimetric personal samplers) were mounted on the drill near the operator control panel. Two other sets of samplers (two gravimetric samplers)

Figure 10

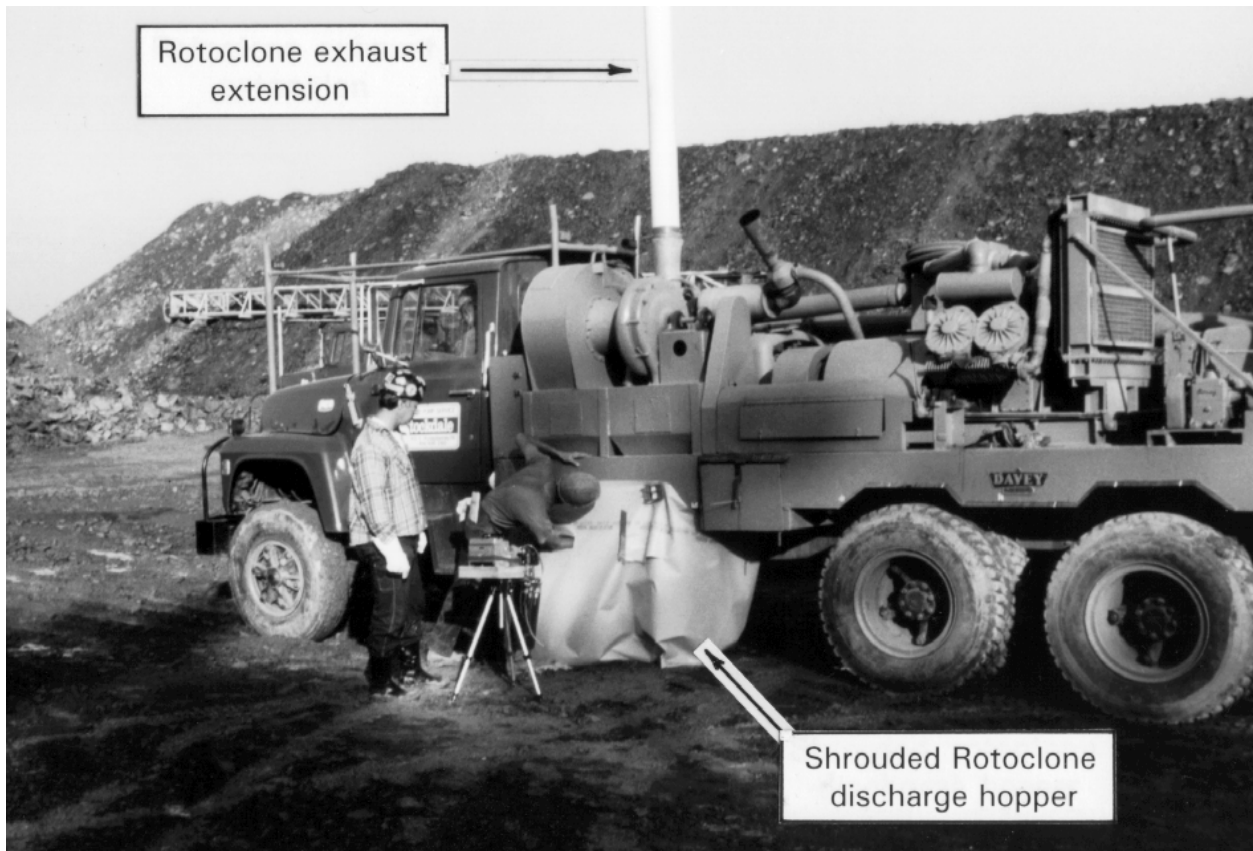

*No visible dust with the shrouded collector dumping operation and field installation of Rotoclone exhaust extended.*



were worn by two USBM personnel standing at two different locations away from the drill deck shroud. One mobile location was positioned near the drill operator close to the drill deck shroud. The other location was about 3.0 m (10 ft) further away from the drill with the USBM employee trying to avoid the dust cloud. The dust sampling results showed that negligible difference was observed between the samplers mounted on the drill (1.56 mg/m<sup>3</sup>) and the samplers worn next to the drill

operator (1.51 mg/m<sup>3</sup>). However, a 69 pct lower dust concentration was observed for the employee standing further back from the drilling deck (0.47 mg/m<sup>3</sup>). These results indicate that a conscientious drill operator can notably reduce his dust exposure by standing away from the drill and only getting near the drill when shoveling cuttings, making drill adjustments, or changing drill steel.

## CONCLUSIONS

Dust surveys conducted around small truck-mounted rock drills operating at surface coal mines showed that a significant amount of airborne respirable dust is emitted from the Rotoclone-type dust collector. At four out of seven drills sampled, respirable dust concentrations measured around the drill deck ranged from 8.68 to 95.15 mg/m<sup>3</sup> with concentrations ranging from 1.37 to 2.69 mg/m<sup>3</sup> at distances 12.2 to 30.5 m (40 to 100 ft) downwind of these drills. Dust was emitted from around the drill deck shroud, collector exhaust, and collector fines dumping. The other three of these seven drills had noticeably lower respirable dust concentrations measured around the drill deck at or below 1.30 mg/m<sup>3</sup>. These drills had well constructed shrouds with smaller gaps, contributing to their lower dust concentrations measured around the drill deck.

Dust sampling around these drills also indicated that wind direction and speed were factors in the dust concentrations measured on the bench. Cyclones of the gravimetric samplers oriented into the wind and perpendicular to the wind showed that the dust concentrations measured into the wind tended to be higher than the perpendicular measurement, especially for very high dust concentrations. Prior USBM laboratory research shows that this effect can be present with air speeds as low as 2.0 m/s (400 fpm).

Dust collector improvements were made on several drills to control dust from the emission sources. Dust measurements were made for part of the drilling shift with and without these improvements to evaluate their control effectiveness under

similar drilling conditions. Since drilling operations were constant during the shift, these evaluations are expected to be fairly representative measurements of dust control effectiveness. The evaluation results indicate that—

- Adding a low flow of water 0.76 Lpm (0.2 gpm) to the collector exhaust can reduce the dust emitted by 92 pct.
- Increasing drill deck shroud containment and increasing the rotoclone speed may reduce respirable dust levels by 63 pct.
- Vertically extending the Rotoclone exhaust may reduce downwind respirable dust levels by 62 pct.
- Enclosing the Rotoclone hopper discharge may reduce respirable dust levels by 80 pct.
- Wet drilling by injecting small amounts of water into the bailing air appears to be more effective than an improved Rotoclone drill deck shroud by 29 pct.
- Operator repositioning away from the drill during most of its operation can keep him/her out of the dust cloud and reduce dust levels by 69 pct.

These improvements are inexpensive and showed measurable reductions of airborne respirable dust measured at several locations around the drill. In addition, this class of drill has a much more extensive use in the construction industry. Therefore, the results of this study are of direct benefit in reducing dust exposure to not only a small segment of the mining industry, but the construction work force as well.

## REFERENCES

1. U.S. Code of Federal Regulations. Title 30—Mineral Resources; Chapter I—Mine Safety and Health Administration, Dep. Labor; Subchapter O—Coal Mine Safety and Health; Part 70—Mandatory Health Standards—Underground Coal Mines, Subpart B, Section 70.101; and Part 71—Mandatory Health Standards—Surface Coal Mines and Surface Work Areas of Underground Coal Mines, Subpart B, Section 71.101, U.S. Gov. Print. Off., Off. Fed. Reg., July 1, 1994.
2. U. S. Code of Federal Regulations. Title 29—Labor; Chapter XVII—Occupational Safety and Health Administration, Dep. Labor; Part 1910.1000, U. S. Gov. Print. Off., Off. Fed. Reg., July 1, 1994.
3. Organiscak, J. A., S. J. Page, and R. A. Jankowski. Sources and Characteristics of Quartz Dust in Coal Mines. USBM IC 9271, 1990, 21 pp.
4. Zimmer, R. A., and S. R. Lueck. Investigation of Quartz Dust Sources and Control Mechanisms on Surface Coal Mine Operations (contract J0348032, PEI Associates, Inc.). USBM OFR 61A-86, 1986, 72pp.; NTIS PB 86-215852.
5. Page, S. J. Respirable Dust Control on Overburden Drills at Surface Mines. Published in the Proceedings of the AMC Coal Convention '91, Pittsburgh, PA, June 5, 1991, pp 523-539.
6. NIOSH Alert: Request for Assistance in Preventing Silicosis and Deaths in Rock Drillers [DHHS (NIOSH) 92-107], Aug. 1992, 15 pp.
7. Cecala, A. B., J. C. Volkwein, R. J. Timko, and K. L. Williams. Velocity and Orientation Effects on the 10-mm Dorr-Oliver Cyclone. USBM RI 8764, 1983, 11 pp.