

SEC Petition Evaluation Report Petition SEC-00219

Report Rev #:0

Report Submittal Date: March 12, 2015

Subject Expert(s):		Mitch Findley, Brian Gleckler, Jason Davis, Mike Mahathy		
Site Expert(s):		N/A		
Petition Administrative Summary				
Petition Under Evaluation				
Petition #	Petition Type	Petition Receipt Date	Qualification Date	DOE/AWE Facility Name
SEC-00219	83.13	July 8, 2014	September 16, 2014	Idaho National Laboratory
Petitioner-Requested Class Definition				
All employees who worked in any area of the Idaho National Laboratory from January 1, 1949 through December 31, 1970.				
Class Evaluated by NIOSH				
All employees who worked in any area of the Idaho National Laboratory from January 1, 1949 through December 31, 1970.				
NIOSH-Proposed Class(es) to be Added to the SEC				
All employees of the Department of Energy, its predecessor agencies, and their contractors and subcontractors who worked at the Idaho National Laboratory in Scoville, Idaho, and were monitored for external radiation at the Idaho Chemical Processing Plant (CPP) (e.g., at least one film badge or TLD dosimeter from CPP) between January 1, 1963 and December 31, 1974 for a number of work days aggregating at least 250 work days, occurring either solely under this employment, or in combination with work days within the parameters established for one or more other classes of employees in the Special Exposure Cohort.				
Related Petition Summary Information				
SEC Petition Tracking #(s)	Petition Type	DOE/AWE Facility Name	Petition Status	
N/A	N/A	N/A	N/A	
Related Evaluation Report Information				
Report Title	DOE/AWE Facility Name			
N/A	N/A			
ORAU Lead Technical Evaluator: Mitch Findley		ORAU Peer Review Completed By: Dan Stempfley		
Peer Review Completed By:		[Signature on File] <i>Timothy Taulbee</i>	<u>3/12/2015</u> <i>Date</i>	
SEC Petition Evaluation Reviewed By:		[Signature on File] <i>James W. Neton</i>	<u>3/12/2015</u> <i>Date</i>	
SEC Evaluation Approved By:		[Signature on File] <i>Stuart L. Hinnefeld</i>	<u>3/12/2015</u> <i>Date</i>	

This page intentionally left blank

Evaluation Report Summary: SEC-00219, Idaho National Laboratory

This evaluation report by the National Institute for Occupational Safety and Health (NIOSH) addresses a class of employees proposed for addition to the Special Exposure Cohort (SEC) per the *Energy Employees Occupational Illness Compensation Program Act of 2000*, as amended, 42 U.S.C. § 7384 *et seq.* (EEOICPA) and 42 C.F.R. pt. 83, *Procedures for Designating Classes of Employees as Members of the Special Exposure Cohort under the Energy Employees Occupational Illness Compensation Program Act of 2000*.

Petitioner-Requested Class Definition

Petition SEC-00219 was received on July 8, 2014, and qualified on September 16, 2014. The petitioner requested that NIOSH consider the following class: *All employees who worked in any area of the Idaho National Laboratory from January 1, 1949 through December 31, 1970.*

Class Evaluated by NIOSH

Based on its preliminary research, NIOSH accepted the petitioner-requested class. NIOSH evaluated the following class: All employees who worked in any area of the Idaho National Laboratory from January 1, 1949 through December 31, 1970.

NIOSH-Proposed Class(es) to be Added to the SEC

Based on its full research of the class under evaluation, NIOSH has defined a single class of employees for which NIOSH cannot estimate radiation doses with sufficient accuracy. The NIOSH-proposed class includes all employees of the Department of Energy, its predecessor agencies, and their contractors and subcontractors who worked at the Idaho National Laboratory in Scoville, Idaho, and were monitored for external radiation at the Idaho Chemical Processing Plant (CPP) (e.g., at least one film badge or TLD dosimeter from CPP) between January 1, 1963 and December 31, 1974 for a number of work days aggregating at least 250 work days, occurring either solely under this employment, or in combination with work days within the parameters established for one or more other classes of employees in the Special Exposure Cohort.

The proposed class differs from the class selected for evaluation by NIOSH because the operating area and time period for which dose reconstruction is deemed infeasible for the period evaluated in this report is limited to the CPP. The SEC class start date was established as January 1, 1963 because, in the face of increased alpha contamination, the CPP radiation protection program did not initiate a corresponding increase in the number of bioassay samples taken. The *Preliminary ICPP Health Physics Upgrade Program* report was published and delivered to management in October 1974. Although the proposed class end date is identified as December 31, 1974, further NIOSH-ORAUT review and assessment will be necessary to determine if the program data from 1975 forward is adequate to support reconstructing dose with sufficient accuracy for this area.

Feasibility of Dose Reconstruction

NIOSH finds it is not feasible to estimate internal exposures with sufficient accuracy for all workers who worked in the Chemical Processing Plant at INL from January 1, 1963 through December 31, 1974. With the exception of this class, per EEOICPA and 42 C.F.R. § 83.13(c)(1), NIOSH has established that it has access to sufficient information to: (1) estimate the maximum radiation dose, for every type of cancer for which radiation doses are reconstructed, that could have been incurred in plausible circumstances by any member of the class; or (2) estimate radiation doses more precisely than an estimate of maximum dose. Information available from the site profile and additional resources is sufficient to document or estimate the maximum internal and external potential exposure to members of the evaluated class under plausible circumstances during the specified period. For the remainder of the INL site, other than the locations and periods defined as reserved for further assessment and evaluation, dose reconstructions are deemed feasible at INL from January 1, 1949 through December 31, 1970.

The NIOSH dose reconstruction feasibility findings are based on the following:

- Operations at the site began in 1949, when the Atomic Energy Commission (AEC) established the National Reactor Testing Station (NRTS). The site, known today as the Idaho National Laboratory (INL), was the primary nuclear reactor development laboratory in the United States. Over 100 reactor concepts were conceived and tested there. Between 1953 and 1992, the Idaho Chemical Processing Plant (CPP) at INL reprocessed spent nuclear fuel from naval propulsion, test, and research reactors to recover enriched uranium for reuse in nuclear weapons production. Other facilities at INL also conducted various nuclear weapons research and development activities over the INL operational period evaluated in this report.
- Principal sources of internal radiation for members of the proposed class included inhalation and ingestion exposures to various isotopes of uranium, thorium, and plutonium, tritium, exotic radionuclides (produced from, or as a result of, reactor neutron irradiation), and mixed fission and activation products (MFP/MAP). These materials were most widely used and present on site at INL in the Test Reactor Area (TRA), Chemical Processing Plant (CPP), Test Area North (TAN), Miscellaneous Reactor Areas, Central Facilities Area (CFA), and Burial Ground.
 - TRA: NIOSH has determined that the internal dose potential during the period under evaluation at the TRA is associated with reactors, laboratories, machine shops, and other research and support activities as well as radioactive waste disposal. There was limited personnel internal exposure potential to alpha-emitting radionuclides, including plutonium and other actinides, during the evaluated period. Personnel monitoring data for mixed fission products exposures exist to support reconstructing doses for INL workers at during the evaluated period.

- CPP: NIOSH has determined that the internal dose potential at CPP over the evaluated period was related to its primary function of processing spent fuel elements containing enriched uranium for the recovery of the un-fissioned uranium. The uranium was separated from fission products by continuous liquid-liquid extraction. Although much of the processing equipment was heavily-shielded and operated remotely, the plant design was based on a direct-contact maintenance philosophy. There was known alpha contamination (from unspecified alpha-emitting radionuclides) in the Analytical Labs, a routine exposure potential from the Np-Pu campaign, routine exposure potential from the Umpire Program, radiological program degradation including decreased personnel monitoring, and limited plutonium monitoring data over the evaluation period.
- TAN: NIOSH has determined that the internal dose potential at TAN was related to the initial work for the Aircraft Nuclear Propulsion (ANP) Program, which was eventually terminated, after which operations shifted to the Safety Test Engineering Program (STEP). The overall objectives at TAN included conducting full-scale tests on reactor systems to determine what actually happens to fission products released during a reactor accident, demonstrating reactor safety, developing realistic analytical methods useful for future reactor designs, and using basic information already developed in the Nuclear Safety Program. There was no appreciable exposure to actinides without a correlating exposure to MFPs, which allows for relating the MFP and actinide exposure data.
- Misc. Reactor Areas: NIOSH has determined that internal exposures in the Miscellaneous Reactor Areas, which includes the Auxiliary Reactor Area (ARA), Organic Moderated Reactor Experiment (OMRE), and the Special Power Excursion Reactor Tests (SPERT), are related to reactor and hot cell operations and testing. The exposures in these areas are primarily related to MFP for which personnel monitoring data are available. One exception involved the separation of Pa-233 from irradiated thorium slugs at the ARA-I hot cells in 1968. NIOSH will be evaluating this work and related personnel monitoring separately.
- CFA: NIOSH has determined that internal exposures at the CFA were related to the laundry facility, support laboratory, and support machine shop operations. The exposures in these areas are primarily related to uranium and MFP for which personnel monitoring data are available.
- Burial Ground: NIOSH has determined that internal exposures at the Burial Ground were directly related to the materials being disposed of in the grounds. Up to the point in time that drum retrieval commenced in 1969, exposure potential was virtually all from mixed fission products in the INL waste being buried, and plutonium for the Rocky Flats Plant waste that was received for disposal. Internal monitoring data are available for the workers who supported the waste disposal activities. While data are also available for the drum-retrieval work that started in 1969, the exposure potential and issues are necessarily different and requires additional assessment and analysis.

- NIOSH has determined that it has access to sufficient personnel and area monitoring data to support internal dose reconstruction with sufficient accuracy for INL workers during the time period evaluated in this report, with the exception of workers at CPP from January 1, 1963 through December 31, 1974 and reserved portions of the class, which include:
 - TAN: TAN-607 (Fuel Storage Vaults) and TAN-615 (Actuator Building) from 1961-1970 due to potential uranium exposures without mixed fission products being present
 - Misc. Reactor Areas: ARA-I in 1968 due to potential unmonitored exposure to Pa-233
 - Burial Ground: The years 1969 forward due to a newly-implemented procedure of waste exhumation and retrieval
- For the period from January 1, 1963 through December 31, 1974 at CPP, NIOSH has not located sufficient personnel or area monitoring documentation to support complete reconstruction of internal personnel exposures to uranium, neptunium, plutonium, and other related transuranic radionuclides. Without additional personnel radiation monitoring data or air monitoring data during this period, NIOSH has insufficient information to appropriately characterize radioactive material intakes of these radionuclides during these INL operations.
- Principal sources of external radiation for members of the proposed class included beta-gamma, and neutron exposures from various isotopes of uranium, thorium, and plutonium, tritium, exotic radionuclides (produced from, or as a result of, reactor neutron irradiation), and mixed fission and activation products (MFP/MAP). These materials were most widely used and present on site at INL in the Test Reactor Area (TRA), Chemical Processing Plant (CPP), Test Area North (TAN), Miscellaneous Reactor Areas, Central Facilities Area (CFA), and Burial Ground. By policy, INL monitored by dosimeter all personnel who were expected to receive any radiation dose or whose work was centered at the site. The six major areas below required external dosimetry (film or TLD) be worn within the operating (fenced) area; this dosimetry was issued at the guard checkpoint; when a worker went from one area to another, a dosimeter was issued at each location.
 - TRA: NIOSH has determined that the beta-gamma external dose potential during the period under evaluation at the TRA (based primarily on MFP) is associated with reactors, laboratories, machine shops, and other research and support activities as well as radioactive waste disposal. The neutron external dose potential during the period under evaluation at the TRA is associated with reactors and sources, and also from the Fast Chopper and Crystal Spectrometer.
 - CPP: NIOSH has determined that the beta-gamma external dose potential during the period under evaluation at the CPP is associated with fuel reprocessing, handling raffinates and calcined wastes, handling fuel cladding, and Radioactive Lanthanum (RaLa) work. The neutron external dose potential during the period under evaluation at the CPP was associated primarily with the handling of transuranic (TRU) isotopes and spontaneous fission of radionuclides.

- TAN: NIOSH has determined that the beta-gamma external dose potential during the period under evaluation at the TAN (based primarily on MFP) is associated with fuel nuclear reactors, activated materials, and irradiated reactor fuels. The neutron external dose potential during the period under evaluation at the TAN was associated primarily with operation of nuclear reactors and exposure to irradiated reactor fuels.
 - Misc. Reactor Areas: NIOSH has determined that the beta-gamma external dose potential during the period under evaluation at the Misc. Reactor Areas (based primarily on MFP), which includes the Auxiliary Reactor Area (ARA), Organic Moderated Reactor Experiment (OMRE), and the Special Power Excursion Reactor Tests (SPERT) is associated with reactors, laboratories, and other research and support activities. The neutron external dose potential during the period under evaluation at the Misc. Reactor Areas is associated with reactors and sources.
 - CFA: NIOSH has determined that the beta-gamma external dose potential during the period under evaluation at the CFA (based primarily on MFP) is associated with residual exposure to radionuclides from the other facilities. The neutron external dose potential during the period under evaluation at the CFA is unlikely, but would be associated with residual exposure to radionuclides from the other facilities if it did exist.
 - Burial Ground: NIOSH has determined that the beta-gamma external dose potential during the period under evaluation at the Burial Ground (based primarily on MFP) is associated with residual exposure to radionuclides based on disposal of wastes from the other facilities. The neutron external dose potential during the period under evaluation at the Burial Ground is unlikely, but would be associated with residual exposure to radionuclides in the wastes from the other facilities if it did exist.
- NIOSH has demonstrated that it has access to sufficient personnel and area monitoring data to support external dose reconstruction with sufficient accuracy for the worker class and time period evaluated in this report.
 - NIOSH finds that it is likely feasible to reconstruct occupational medical dose for INL workers with sufficient accuracy for the worker class and time period evaluated in this report.

Pursuant to 42 C.F.R. § 83.13(c)(1), NIOSH determined that there is insufficient information to either: (1) estimate the maximum radiation dose, for every type of cancer for which radiation doses are reconstructed, that could have been incurred under plausible circumstances by any member of the class; or (2) estimate the radiation doses of members of the class more precisely than a maximum dose estimate.

Although NIOSH found that it is not possible to completely reconstruct radiation doses for the proposed class, NIOSH intends to use any internal and external monitoring data that may become available for an individual claim (and that can be interpreted using existing NIOSH dose reconstruction processes or procedures). Therefore, dose reconstructions for individuals employed in the Chemical Processing Plant at the Idaho National Laboratory during the period from January 1, 1963 through December 31, 1974, but who do not qualify for inclusion in the SEC, may be performed using these data as appropriate.

Health Endangerment Determination

Per EEOICPA and 42 C.F.R. § 83.13(c)(3), a health endangerment determination is required because NIOSH has determined that it does not have sufficient information to estimate dose for the members of the proposed class from January 1, 1963 through December 31, 1974.

NIOSH did not identify any evidence supplied by the petitioners or from other resources that would establish that members of the proposed SEC class at the Idaho Chemical Processing Plant (CPP) between January 1, 1963 and December 31, 1974 were exposed to radiation during a discrete incident resulting in significant unmonitored exposures likely to have involved exceptionally high-level exposures. However, evidence indicates that some workers in the proposed class may have accumulated substantial chronic exposures through episodic intakes of radionuclides, combined with external exposures to gamma, beta, and neutron radiation. Consequently, NIOSH has determined that health was endangered for those workers covered by this evaluation who were employed for at least 250 aggregated work days either solely under their employment or in combination with work days within the parameters established for other SEC classes.

For the workers at the INL site for the period of January 1, 1949 through December 31, 1970 (excluding the CPP workers from January 1, 1963 through December 31, 1974, and those workers in the areas with reserved periods in this report), a health endangerment determination is not required because NIOSH has determined that it has sufficient information to estimate dose for the members of the evaluated class.

Table of Contents

1.0	Purpose and Scope.....	17
2.0	Introduction	17
3.0	SEC-00219 Idaho National Laboratory Class Definitions	18
3.1	Petitioner-Requested Class Definition and Basis.....	18
3.2	Class Evaluated by NIOSH	19
3.3	NIOSH-Proposed Class(es) to be Added to the SEC	19
4.0	Data Sources Reviewed by NIOSH to Evaluate the Class	20
4.1	Site Profile Technical Basis Documents (TBDs)	23
4.2	ORAU Technical Information Bulletins (OTIBs) and Procedures	23
4.3	Facility Employees and Experts	25
4.4	Previous Dose Reconstructions	26
4.5	NIOSH Site Research Database	27
4.6	Documentation and/or Affidavits Provided by Petitioners	27
5.0	Radiological Operations Relevant to the Class Evaluated by NIOSH	27
5.1	Idaho National Laboratory Plant and Process Descriptions	27
5.1.1	Test Reactor Area (TRA)	31
5.1.1.1	Materials Test Reactor (MTR)	33
5.1.1.2	Engineering Test Reactor (ETR).....	38
5.1.1.3	Advanced Test Reactor (ATR).....	39
5.1.1.4	Reactivity Measurement Facility (RMF).....	42
5.1.1.5	Advanced Reactivity Measurement Facility No. 1 (ARMF-I).....	43
5.1.1.6	Advanced Reactivity Measurement Facility No. 2 (ARMF-II).....	43
5.1.1.7	Engineering Test Reactor Critical Facility (ERTC)	43
5.1.1.8	Advanced Test Reactor Critical Facility (ATRC).....	44
5.1.1.9	Hot Cell Facility	45
5.1.1.10	TRA Gamma Facility	48
5.1.1.11	Radiation Measurement Laboratory (RML).....	48
5.1.1.12	Radiochemistry Laboratories.....	48
5.1.1.13	HB-4 Crystal Spectrometer	51
5.1.1.14	Fast (Neutron) Chopper	51
5.1.2	Chemical Processing Plant (CPP)	52
5.1.2.1	CPP-601, Main Processing Building.....	54
5.1.2.2	CPP-602 Laboratory	62
5.1.2.3	CPP-603, Fuel Storage Building	63
5.1.2.4	CPP-604/605, Waste Disposal Building and Rare Gas Plant.....	64
5.1.2.5	CPP-620, Chemical Engineering / High-Bay Laboratory	64
5.1.2.6	CPP-627, Remote Analytical Facility	64
5.1.2.7	CPP-630, Mass Spectrometry Facility	66
5.1.2.8	CPP-631, RaLa Off-Gas Filter Building.....	66
5.1.2.9	CPP-633, Waste Calcining Facility.....	66

5.1.2.10	CPP-637, Process Improvement Facility / Low-Bay Laboratory.....	68
5.1.2.11	CPP-640, Hot Pilot Plant/Headend Process Plant.....	68
5.1.2.12	CPP-709, Eastside Service Waste (ESSW) Monitoring Station.....	69
5.1.2.13	CPP-734, Westside Service Waste (WSSW) Monitoring Station.....	69
5.1.2.14	High Level Liquid Waste Tank Farm.....	69
5.1.2.15	Calcined Solids Storage Facilities (CSSF).....	70
5.1.2.16	Auxiliary CPP Facilities (Non-Radiological).....	70
5.1.2.17	Overview: Fuel Reprocessing Operations.....	70
5.1.2.18	Overview: Isotope Recovery.....	73
5.1.2.19	Overview: Waste Calcination.....	74
5.1.3	Test Area North (TAN).....	76
5.1.3.1	Technical Support Facilities (TSF).....	79
5.1.3.2	IET Facility.....	86
5.1.3.3	Flight Engine Test (FET)/Loss-Of-Fluid Test (LOFT) Facility.....	90
5.1.3.4	Low Power Test Facility (LPTF) Area.....	92
5.1.4	Misc. Reactor Areas (ARA, OMRE, SPERT).....	95
5.1.4.1	Auxiliary Reactor Area (ARA).....	95
5.1.4.2	Organic Moderated Reactor Experiment (OMRE).....	99
5.1.4.3	Special Power Excursion Reactor Tests (SPERT).....	100
5.1.5	Central Facilities Area (CFA).....	103
5.1.6	Burial Ground.....	107
5.2	Internal Radiological Exposure Sources from INL Operations.....	113
5.2.1	Internal Radiological Exposure Sources from Test Reactor Area Operations.....	113
5.2.1.1	Fission and Activation Products.....	114
5.2.1.2	Exotic Radionuclides.....	114
5.2.1.3	Plutonium.....	114
5.2.1.4	Uranium.....	115
5.2.1.5	Thorium.....	115
5.2.2	Internal Radiological Exposure Sources from CPP Operations.....	115
5.2.2.1	Uranium.....	116
5.2.2.2	Neptunium.....	117
5.2.2.3	Plutonium.....	118
5.2.2.4	Fission and Activation Products.....	119
5.2.2.5	Barium/Lanthanum.....	121
5.2.2.6	Thorium.....	121
5.2.2.7	Radioactive Noble Gases.....	121
5.2.2.8	Iodine.....	122
5.2.2.9	Tritium.....	123
5.2.3	Internal Radiological Exposure Sources from TAN Operations.....	123
5.2.3.1	Mixed Fission and Activation Products.....	124
5.2.3.2	Radioiodines.....	124
5.2.3.3	Radioactive Noble Gases.....	124
5.2.3.4	Plutonium.....	125
5.2.3.5	Neptunium.....	125
5.2.3.6	Uranium.....	125
5.2.3.7	Other Actinides.....	125
5.2.3.8	Other Radionuclides.....	125

5.2.4	Internal Radiological Exposure Sources from Misc. Reactor Areas Operations ..	126
5.2.4.1	Fission and Activation Products	126
5.2.4.2	Exotic Radionuclides	127
5.2.4.3	Radioactive Noble Gases	128
5.2.4.4	Iodine	128
5.2.4.5	Uranium	129
5.2.5	Internal Radiological Exposure Sources from CFA Operations	129
5.2.5.1	Fission and Activation Products	130
5.2.5.2	Uranium	130
5.2.6	Internal Radiological Exposure Sources from Burial Ground Operations	130
5.2.6.1	Fission and Activation Products	131
5.2.6.2	Plutonium	132
5.3	External Radiological Exposure Sources from INL Operations	133
5.3.1	External Radiological Exposure Sources from Test Reactor Area Operations	136
5.3.1.1	Photon	136
5.3.1.2	Beta	136
5.3.1.3	Neutron	136
5.3.2	External Radiological Exposure Sources from CPP Operations	136
5.3.2.1	Photon	136
5.3.2.2	Beta	139
5.3.2.3	Neutron	139
5.3.3	External Radiological Exposure Sources from TAN Operations	139
5.3.3.1	Photon	139
5.3.3.2	Beta	140
5.3.3.3	Neutron	140
5.3.4	External Radiological Exposure Sources from Misc. Reactor Areas Operations ..	140
5.3.4.1	Photon	140
5.3.4.2	Beta	141
5.3.4.3	Neutron	141
5.3.5	External Radiological Exposure Sources from CFA Operations	141
5.3.5.1	Photon	141
5.3.5.2	Beta	142
5.3.6	External Radiological Exposure Sources from Burial Ground Operations	142
5.3.6.1	Photon	142
5.3.6.2	Beta	142
5.4	Incidents	143
5.4.1	Incidents at the Test Reactor Area	143
5.4.2	Incidents at the Chemical Processing Plant	148
5.4.3	Incidents at Test Area North	151
5.4.4	Incidents at the Misc. Reactor Areas	152
5.4.5	Incidents at Central Facilities Area	153
5.4.6	Incidents at the Burial Ground	153

6.0	Summary of Available Monitoring Data for the Class Evaluated by NIOSH	154
6.1	Available INL Internal Monitoring Data.....	154
6.2	Available INL External Monitoring Data.....	158
6.3	Available Radiological Monitoring Data	161
6.3.1	Available Radiological Monitoring Data for TRA.....	161
6.3.2	Available Radiological Monitoring Data for CPP.....	163
6.3.3	Available Radiological Monitoring Data for TAN	171
6.3.4	Available Radiological Monitoring Data for Misc. Reactor Areas.....	174
6.3.5	Available Radiological Monitoring Data for CFA.....	175
6.3.6	Available Radiological Monitoring Data for the Burial Ground.....	176
7.0	Feasibility of Dose Reconstruction for the Class Evaluated by NIOSH.....	177
7.1	Pedigree of INL Data.....	177
7.1.1	Internal Monitoring Data Pedigree Review.....	178
7.1.2	External Monitoring Data Pedigree Review.....	179
7.2	Evaluation of Bounding Internal Radiation Doses at INL	179
7.2.1	Evaluation of Bounding Internal Doses for TRA.....	181
7.2.1.1	Evaluation of Bounding Process-Related Internal Doses for TRA	181
7.2.1.2	Methods for Bounding Operational Period Internal Dose for TRA	185
7.2.2	Evaluation of Bounding Internal Doses for CPP.....	186
7.2.2.1	Evaluation of Bounding Process-Related Internal Doses for CPP	186
7.2.2.2	Methods for Bounding Operational Period Internal Dose for CPP.....	191
7.2.3	Evaluation of Bounding Internal Doses for TAN.....	195
7.2.3.1	Evaluation of Bounding Process-Related Internal Doses for TAN.....	196
7.2.3.2	Methods for Bounding Operational Period Internal Dose for TAN.....	197
7.2.4	Evaluation of Bounding Internal Doses for Misc. Reactor Areas	199
7.2.4.1	Evaluation of Bounding Process-Related Internal Doses for Misc. Reactor Areas.....	199
7.2.4.2	Methods for Bounding Operational Period Internal Dose for Misc. Reactor Areas	201
7.2.5	Evaluation of Bounding Internal Doses for CFA	202
7.2.5.1	Evaluation of Bounding Process-Related Internal Doses for CFA	203
7.2.5.2	Methods for Bounding Operational Period Internal Dose for CFA	204
7.2.6	Evaluation of Bounding Internal Doses for the Burial Ground.....	205
7.2.6.1	Evaluation of Bounding Process-Related Internal Doses for the Burial Ground.....	206
7.2.6.2	Methods for Bounding Operational Period Internal Dose for the Burial Ground.....	207
7.2.7	Internal Dose Reconstruction Feasibility Conclusion	208
7.3	Evaluation of Bounding External Radiation Doses at INL	210
7.3.1	Evaluation of Bounding Process-Related External Doses.....	210
7.3.1.1	Electron and Photon Dosimetry Data	210
7.3.1.2	Neutron Dosimetry Data.....	210
7.3.2	Evaluation of Bounding Ambient Environmental External Doses.....	211
7.3.3	Evaluation of Bounding Occupational Medical Doses	211
7.3.4	Methods for Bounding External Dose at INL	212
7.3.4.1	Methods for Bounding Operational Period External Dose.....	212

7.3.4.2	Methods for Bounding Ambient Environmental External Doses.....	212
7.3.5	External Dose Reconstruction Feasibility Conclusion	213
7.4	Evaluation of Petition Basis for SEC-00219	213
7.5	Other Potential SEC Issues Relevant to the Petition Identified During the Evaluation....	214
7.6	Summary of Feasibility Findings for Petition SEC-00219.....	218
8.0	Evaluation of Health Endangerment for Petition SEC-00219.....	221
9.0	Class Conclusion for Petition SEC-00219	222
10.0	References	223
	Attachment 1: Data Capture Synopsis.....	245

Tables

Table 4-1:	INL Data Capture Visits	21
Table 4-2:	No. of INL Claims Submitted Under the Dose Reconstruction Rule	26
Table 5-1:	INL Test Reactor Area (TRA) Reactors and Support Facilities	32
Table 5-2:	INL Chemical Processing Plant (CPP) Processing and Support Facilities	52
Table 5-3:	CPP-601, Main Processing Building Cells	61
Table 5-4:	Notable Radiological Structures at the TAN	78
Table 5-5:	Nuclear Reactors that Operated at the LPTF	94
Table 5-6:	Dose Conversion Factors for Kr-85 and Xe-133	116
Table 5-7:	Fiscal Year-End Inventories of Radioactive Liquid Waste Activities	120
Table 5-8:	Fiscal Year-End Inventories of Calcined Solid Waste Activities	120
Table 5-9:	Radioactive Noble Gases Released During Dissolution of Spent Fuel	121
Table 5-10:	I-131 Release from C Cell Dissolving Operations During December 1956.....	122
Table 5-11:	Radionuclides Measured in OMRE Coolant.....	127
Table 5-12:	Example Air Effluent Inventory for SL-1 (ARA-II).....	128
Table 5-13:	Solid Radioactive Waste at INL Burial Ground	131
Table 5-14:	Estimated Quantities of Radioactive Materials From Rocky Flats.....	132
Table 5-15:	INL Beta-Gamma Dosimetry Systems History and LOD Summary	134
Table 5-16:	INL Neutron Dosimetry Systems History and LOD Summary	135
Table 5-17:	Mixed Fission Product Gamma and Beta Emitters.....	135
Table 5-18:	Mixed Fission Products from the RaLa Process	138
Table 6-1:	<i>In-Vitro</i> Measurements for INL, 1953-1975.....	156
Table 6-2:	<i>In-Vivo</i> Measurements for INL, 1961-1975.....	157
Table 6-3:	Historic External Radiation Exposure Distribution for INL ^a	159
Table 7-1:	Feasibility Summary for TRA (1952-1970)	181
Table 7-2:	Special Samples Collected at the TRA	183

Table 7-3 [Radionuclide redacted] Bioassay Results for [Location and Role redacted]	183
Table 7-4: MTR Smear Totals	184
Table 7-5: Feasibility Summary for CPP (1953-1974)	186
Table 7-6: CPP-Specific Internal Monitoring Records	187
Table 7-7: CPP Permissible Airborne Contamination Levels	190
Table 7-8: CPP Contamination Monitoring	191
Table 7-9: Feasibility Summary for TAN (1955-1970)	196
Table 7-10: Feasibility Summary for Misc. Reactor Areas (1955-1970)	199
Table 7-11: Miscellaneous Reactor Area-Specific Internal Monitoring Results	200
Table 7-12: SPERT Whole Body Count Monitoring Frequency	201
Table 7-13: Feasibility Summary for Central Facilities Area (1949-1970)	202
Table 7-14: Central Facilities Area-Specific Internal Monitoring Results	203
Table 7-15: Feasibility Summary for the Burial Ground (1952-1970)	205
Table 7-16: Example of Rocky Flats Waste Burial Schedule, February-August 1963	207
Table 7-17: Summary of Feasibility Findings for SEC-00219	218
Table 7-18: Summary of INL Feasibility Determinations by Operating Area (1949-1974)	220

Figures

Figure 5-1: INL Location in Idaho	28
Figure 5-2: Layout of INL Facilities	29
Figure 5-3: Idaho National Laboratory Employment, 1951-1975	30
Figure 5-4: Map Location, TRA	31
Figure 5-5: Test Reactor Area (TRA) Complex, 1956	33
Figure 5-6: Inserting a Sample Rabbit in a Beam Port	35
Figure 5-7: MTR Vertical Section Diagram (North-south Centerline Looking West)	36
Figure 5-8: A Portion of the MTR Canal	37
Figure 5-9: ETR Reactor	38
Figure 5-10: Advanced Test Reactor Complex (ATR in Center)	40
Figure 5-11: ATR Ground Floor	41
Figure 5-12: Radiation Measurement Facility	42
Figure 5-13: The Engineering Test Reactor Critical Facility (ETRC)	44
Figure 5-14: TRA Hot Cell #1	46
Figure 5-15: TRA Hot Cell #2	46
Figure 5-16: TRA Hot Cell #2	47
Figure 5-17: TRA Hot Cell Building, Internal Layout	47
Figure 5-18: Lab 110, MTR Laboratory Wing	49
Figure 5-19: Alpha Lab 127, MTR Laboratory Wing	49
Figure 5-20: Scientist Machining Thorium, Alpha Lab, 1964	50
Figure 5-21: Preparation of Pure Pa-233, Alpha Cave	51
Figure 5-22: Map of CPP Facilities	53
Figure 5-23: Locations of CPP-601, CPP-602, CPP-630, and CPP-640	54
Figure 5-24: Perspective Drawing of CPP-601, Main Processing Building	55
Figure 5-25: Operating Face of L-Cell	58
Figure 5-26: Shielded Glove Boxes in the Remote Analytical Facility	65

Figure 5-27: Map of Test Area North (TAN).....	77
Figure 5-28: Map of the Technical Support Facilities (TSF).....	80
Figure 5-29: Floor Plan of the A&M Building (TAN-607).....	82
Figure 5-30: Floor Plan of Hot Cell Annex (TAN-633).....	85
Figure 5-31: Aerial Photograph of the IET Facility (facing east).....	88
Figure 5-32: Map of the IET Facility.....	89
Figure 5-33: Map of the FET/LOFT Facility.....	91
Figure 5-34: Map of the LPTF Area.....	92
Figure 5-35: Photograph of the LPTF Area (looking northwest).....	93
Figure 5-36: ARA-I Hot Cell Wall with Viewing Windows and Remote-Handling Manipulators.....	96
Figure 5-37: SL-1 in 1960 (Prior to 1961 Accident).....	97
Figure 5-38: ML-1 After Being Moved to ARA-III.....	98
Figure 5-39: SPERT Area.....	101
Figure 5-40: The SPERT-I Facility.....	102
Figure 5-41: Map of the Central Facilities Area in 1961 with Buildings of Interest.....	104
Figure 5-42: ETR Reactor Vessel Arriving at CFA Gantry Crane in 1956.....	106
Figure 5-43: Road to the Burial Ground in 1961.....	107
Figure 5-44: Burial Ground, circa 1955.....	108
Figure 5-45: Emplacement of Rocky Flats Drums in a Burial Ground Pit in 1958.....	109
Figure 5-46: Mass Dumping of Rocky Flats TRU Drums in 1969.....	110
Figure 5-47: January 1969 Flooding of Burial Ground.....	111
Figure 5-48: Schematic of a Transuranic Storage Area.....	112
Figure 5-49: Current Map of the Burial Ground and Associated Facilities.....	112
Figure 5-50: Schematic of Moveable Glove Box (Initial Cause of Pu-240 Contamination).....	146
Figure 6-1: Radiation Survey of KAPL F/H-10 Cubicle in ETR, 4/24/64.....	162
Figure 6-2: Radiological Survey of MTR Alpha Labs June 6, 1962.....	163
Figure 6-3: Comparison of CPP-601 Access Corridor Contamination Surveys: 1961.....	164
Figure 6-4: Comparison of CPP-601 Access Corridor Contamination Surveys: 1963.....	165
Figure 6-5: Comparison of CPP-601 Access Corridor Contamination Surveys: 1965.....	166
Figure 6-6: Comparison of CPP-601 Access Corridor Contamination Surveys: 1969.....	167
Figure 6-7: Comparison of CPP-601 Access Corridor Contamination Surveys: 1970.....	168
Figure 6-8: Example Contamination Survey for CPP-204 and CPP-207 in 1968.....	170
Figure 6-9: Survey Schedule for Part of the TAN-607 Building.....	172
Figure 6-10: Example of Contamination Survey of TAN-633 (Hot Cell Annex).....	173
Figure 6-11: Excerpt from SPERT Health Physics Monitoring Report, Aug. 1963.....	174
Figure 6-12: Excerpt from CFA Health Physics Monthly Report, Jul. 1961.....	175
Figure 6-13: Safe Work Permit for RFP Waste Burial at INL Burial Ground, Apr. 1964.....	176
Figure 7-1: CPP Whole Body Count Frequency Schedule for 1963.....	188

This page intentionally left blank

SEC Petition Evaluation Report for SEC-00219

1.0 Purpose and Scope

This report evaluates the feasibility of reconstructing doses for all employees who worked in any area of the Idaho National Laboratory from January 1, 1949 through December 31, 1970. It provides information and analyses germane to considering a petition for adding a class of employees to the congressionally-created SEC.

This report does not make any determinations concerning the feasibility of dose reconstruction that necessarily apply to any individual energy employee who might require a dose reconstruction from NIOSH. This report also does not contain the final determination as to whether the proposed class will be added to the SEC (see Section 2.0).

This evaluation was conducted in accordance with the requirements of EEOICPA, 42 C.F.R. pt. 83, and the guidance contained in the Division of Compensation Analysis and Support's (DCAS) *Internal Procedures for the Evaluation of Special Exposure Cohort Petitions*, DCAS-PR-004.¹

2.0 Introduction

Both EEOICPA and 42 C.F.R. pt. 83 require NIOSH to evaluate qualified petitions requesting that the Department of Health and Human Services (HHS) add a class of employees to the SEC. The evaluation is intended to provide a fair, science-based determination of whether it is feasible to estimate with sufficient accuracy the radiation doses of the class of employees through NIOSH dose reconstructions.²

42 C.F.R. § 83.13(c)(1) states: *Radiation doses can be estimated with sufficient accuracy if NIOSH has established that it has access to sufficient information to estimate the maximum radiation dose, for every type of cancer for which radiation doses are reconstructed, that could have been incurred in plausible circumstances by any member of the class, or if NIOSH has established that it has access to sufficient information to estimate the radiation doses of members of the class more precisely than an estimate of the maximum radiation dose.*

Under 42 C.F.R. § 83.13(c)(3), if it is not feasible to estimate with sufficient accuracy radiation doses for members of the class, then NIOSH must determine that there is a reasonable likelihood that such radiation doses may have endangered the health of members of the class. The regulation requires NIOSH to assume that any duration of unprotected exposure may have endangered the health of members of a class when it has been established that the class may have been exposed to radiation during a discrete incident likely to have involved levels of exposure similarly high to those occurring during nuclear criticality incidents. If the occurrence of such an exceptionally high-level exposure has not been established, then NIOSH is required to specify that health was endangered for those workers

¹ DCAS was formerly known as the Office of Compensation Analysis and Support (OCAS).

² NIOSH dose reconstructions under EEOICPA are performed using the methods promulgated under 42 C.F.R. pt. 82 and the detailed implementation guidelines available at <http://www.cdc.gov/niosh/ocas>.

who were employed for at least 250 aggregated work days within the parameters established for the class or in combination with work days within the parameters established for one or more other SEC classes.

NIOSH is required to document its evaluation in a report, and to do so, relies upon both its own dose reconstruction expertise as well as technical support from its contractor, Oak Ridge Associated Universities (ORAU). Once completed, NIOSH provides the report to both the petitioner(s) and the Advisory Board on Radiation and Worker Health (Board). The Board will consider the NIOSH evaluation report, together with the petition, petitioner(s) comments, and other information the Board considers appropriate, in order to make recommendations to the Secretary of HHS on whether or not to add one or more classes of employees to the SEC. Once NIOSH has received and considered the advice of the Board, the Director of NIOSH will propose a decision on behalf of HHS. The Secretary of HHS will make the final decision, taking into account the NIOSH evaluation, the advice of the Board, and the proposed decision issued by NIOSH. As part of this decision process, petitioners may seek a review of certain types of final decisions issued by the Secretary of HHS.³

3.0 SEC-00219 Idaho National Laboratory Class Definitions

The following subsections address the evolution of the class definition for SEC-00219, Idaho National Laboratory (INL). When a petition is submitted, the requested class definition is reviewed as submitted. Based on its review of the available site information and data, NIOSH will make a determination whether to qualify for full evaluation all, some, or no part of the petitioner-requested class. If some portion of the petitioner-requested class is qualified, NIOSH will specify that class along with a justification for any modification of the petitioner's class. After a full evaluation of the qualified class, NIOSH will determine whether to propose a class for addition to the SEC and will specify that proposed class definition.

3.1 Petitioner-Requested Class Definition and Basis

Petition SEC-00219 was received on July 8, 2014, and qualified on September 16, 2014. The petitioner requested that NIOSH consider the following class: *All employees who worked in any area of the Idaho National Laboratory from January 1, 1949 through December 31, 1970.*

The petitioner provided information and affidavit statements in support of the petitioner's belief that accurate dose reconstruction over time is impossible for the INL workers in question. NIOSH deemed the following handwritten statement sufficient to qualify SEC-00219 for evaluation:

The petitioner indicated in Section F of the Special Exposure Cohort Petition – Form B, that there was no internal monitoring for plutonium, neptunium, or fission products (Petition, 2014). This serves as the basis for proposing that records and information at INL were inadequate for individual dose reconstruction.

³ See 42 C.F.R. pt. 83 for a full description of the procedures summarized here. Additional internal procedures are available at <http://www.cdc.gov/niosh/ocas>.

The petitioner supplied a signed affidavit on August 29, 2014 (Affidavit, 2014). The affidavit stated “I affirm that to the best of my knowledge regarding the Idaho National Laboratory that there was no internal monitoring for Plutonium, Neptunium, or Fission Products during the employment years of 1947 to 1970. [Note: The year 1947 is in error; INL started in 1949 and the petitioner-requested class specified 1949.]

Based on its INL research and data capture efforts, NIOSH determined that it has access to personnel bioassay monitoring (including urinalysis and fecal sampling), whole-body count data, and external dosimetry data for INL workers during the time period under evaluation. However, NIOSH also determined that internal monitoring records are not complete for all time periods or for all radionuclides. NIOSH concluded that there is sufficient documentation to support, for at least part of the requested time period, the petition basis that internal radiation exposures and radiation doses were not adequately monitored at INL, either through personal monitoring or area monitoring. The information and statements provided by the petitioner qualified the petition for further consideration by NIOSH, the Board, and HHS. The details of the petition basis are addressed in Section 7.4.

3.2 Class Evaluated by NIOSH

Based on its preliminary research, NIOSH accepted the petitioner-requested class. Therefore, NIOSH defined the following class for further evaluation: All employees who worked in any area of the Idaho National Laboratory from January 1, 1949 through December 31, 1970.

3.3 NIOSH-Proposed Class(es) to be Added to the SEC

Based on its research of the class under evaluation, NIOSH has defined a single class of employees for which NIOSH cannot estimate radiation doses with sufficient accuracy. The NIOSH-proposed class to be added to the SEC includes all employees of the Department of Energy, its predecessor agencies, and their contractors and subcontractors who worked at the Idaho National Laboratory in Scoville, Idaho, and were monitored for external radiation at the Idaho Chemical Processing Plant (CPP) (e.g., at least one film badge or TLD dosimeter from CPP) between January 1, 1963 and December 31, 1974 for a number of work days aggregating at least 250 work days, occurring either solely under this employment, or in combination with work days within the parameters established for one or more other classes of employees in the Special Exposure Cohort.

Based on its research, NIOSH concluded that the operating area and time period for which dose reconstruction is deemed infeasible is limited to the CPP. The SEC class start date was established as January 1, 1963 because, in the face of increased alpha contamination, the CPP radiation protection program did not initiate a corresponding increase in the radiological monitoring of the workforce. The class end date was set to December 31, 1974 because there is documented evidence that the CPP radiation protection program did not start improving until 1975. Further NIOSH-ORAUT review and assessment will be necessary to determine if the program data from 1975 forward is adequate to support reconstructing dose with sufficient accuracy for this area.

4.0 Data Sources Reviewed by NIOSH to Evaluate the Class

Idaho National Laboratory uses the Electronic Document Management System (EDMS) to manage records that are in an electronic format. EDMS is made up of multiple client/server and web applications that run on several different operating systems and hardware to provide thousands of users with electronic documents. Preset as well as user-defined queries can be performed. The NIOSH and ORAUT Leads were provided EDMS accounts to allow for searches of non-classified documents during data capture trips in Idaho. EDMS was the primary resource in identifying and capturing documents of interest for the SEC-00219 Evaluation Report.

As is standard practice, NIOSH also completed an extensive database and Internet search for information regarding Idaho National Laboratory. The database search included the DOE Legacy Management Considered Sites database, the DOE Office of Scientific and Technical Information (OSTI) SciTech Connect database, the OSTI Energy Citations database, and the Hanford Declassified Document Retrieval System. In addition to general Internet searches, the NIOSH Internet search included OSTI OpenNet Advanced searches, OSTI Information Bridge Fielded searches, Nuclear Regulatory Commission (NRC) Agency-wide Documents Access and Management (ADAMS) web searches, the DOE-National Nuclear Security Administration-Nevada Site Office-search, the Defense Technical Information Center database (DTIC), the DOE website, the DOE Comprehensive Epidemiologic Data Resource (CEDR), the DOE Environmental Management website, the DOE Oak Ridge Operation website, the Energy Employees Claimant Assistance Project (EECAP) website, the Hathitrust website, the Internet edition of the Health Physics Journal, the National Academies Press website, the Oak Ridge National Laboratory online library and report repository, the University of Hawaii, Manoa online collection, the University of North Texas online collection, the US Army Corps of Engineers website, and the US Transuranium and Uranium website. Attachment 1 contains a summary of INL documents. The summary specifically identifies data capture details and general descriptions of the documents retrieved.

NIOSH and ORAUT staff went on ten data capture trips to assess and scan INL-related documentation. These ten trips resulted in the capture of a wide variety of relevant documentation, including 3,766 documents and 223,569 pages. Table 4-1 lists the INL data capture trips and the types of information obtained.

In addition to the database and Internet searches listed above, NIOSH identified and reviewed numerous data sources to determine information relevant to determining the feasibility of dose reconstruction for the class of employees under evaluation. This included determining the availability of information on personal monitoring, area monitoring, industrial processes, and radiation source materials. The following subsections summarize the data sources identified and reviewed by NIOSH.

Table 4-1: INL Data Capture Visits				
Dates Of Visit (Including Travel)	Volume Reviewed	Documents Captured	Page Count	Brief Summary Of Data Capture Types
01/19/2015 - 01/22/2015	NA	143	789	Continuation of scanning of 10 boxes that were reviewed during site visit the week of January 5th.
01/05/2015 - 01/09/2015	93 Boxes and 1 DVD	552	20,601	Engineering Test Reactor (ETR) film badges including neutron, ETR primary coolant, Idaho Chemical Processing Plant (ICCP), Test Area North (TAN) decontamination logs, disposal of leaking radium sources, selected activity reports of the health physics and monitoring branches, Chemical Processing Plant (CPP) air samples and floor plan surveys, thyroid and urinalysis data for Ferguson Construction, CPP incident reports, excerpts from CPP health physics logs, 1956 radiation shipment survey samples, Central Facilities Area (CFA) daily health physics log sheets, safe work permits for hot cell entries, ETR contamination events, incident study of CPP, ETR safe work permits, Materials Testing Reactor (MTR) shipment records, MTR routine samples to CPP, MTR contamination survey data, CPP safe work permits, TAN radioactive shipments, waste management, annual report on reactor fuels, smear surveys, general decontamination procedures, MTR radioactive discharge records, waste disposal request, ICCP health physics monthly reports, and health and safety monthly report.
12/8/2014 - 12/12/2014	79 Boxes, 6 DVDs	426	33,599	Radioactive material shipment records, Central Facilities Area (CFA) health physics logs, urine sample results, Special Power Excursion Reactor Test (SPERT) health physics logs, Idaho Chemical Processing Plant (ICCP) safe work permits, radioactive and non-radioactive laundry shipments, Center for Advanced Modeling and Simulation (CAMS) filter counts, incident reports for reactor, thyroid counts, film reports, health physics survey sheets, fallout log sheets, daily station reports, SPERT film badge reports, safe work permits, Materials Testing Reactor (MTR) safe work permits, MTR radiation survey data, personnel monitoring practices, MTR gamma facility, SPERT health physics monthly reports, eye exams for neutron damage, Engineering Test Reactor (ETR) water samples, ETR smear surveys, Chemical Processing Plant (CPP) air samples, CPP and MTR health physics logbooks, burial ground photographs, radioactive shipment incidents, contamination incidents, and thyroid counts for 1958.
11/17/2014 - 11/21/2014	49 Boxes	282	9,677	Trip was in support of SEC-00219. Documents included reactor smear surveys, shipment records, safe work permits, monthly reports, waste reports, and health physics logbooks.
10/27/2014 - 10/31/2014	107 Boxes	265	34,156	Trip was in support of SEC-00219. Documents included safe work permits, health physics logbooks, and personnel exposure records. Documents are currently going classification review and will be released after they are cleared.
09/29/2014 - 10/01/2014	NA	106	7,792	Completed scanning documents from 15 boxes from the previous data capture to the site.

Table 4-1: INL Data Capture Visits				
Dates Of Visit (Including Travel)	Volume Reviewed	Documents Captured	Page Count	Brief Summary Of Data Capture Types
09/08/2014 - 09/11/2014	67 Boxes	314	2,804	Radiological incident reports, contamination control letters, criticality safety procedure, medical and urinalysis records, selected reports from possible internal intakes, neutron historical records, whole body count employee records and contamination control upgrade plants.
06/04/2012 - 06 /14/2012	165 Boxes of Records and one box of microfiche	1,176	81,027	Air sample data, incident reports, personnel dosimetry files, health physics procedures, radiation exposure reports, dosimetry data, monthly health physics reports, and air monitoring data.
05/07/2012 - 05/11/2012	71 Boxes	302	22,870	Neutron documents, visitor dosimetry reports, airborne release summaries, air sample data, environmental air monitoring data, personnel contamination, quarterly environmental reports, environmental monitoring program reports, positive whole body count data, contamination control, particle information, health physics logbook, dosimetry procedures for film dosimetry.
04/02/2012 - 04/06/2012	29 Boxes	200	26,489	A site tour was conducted. Also, 29 boxes were reviewed. The selected documents were scanned and are awaiting classification review.
TOTALS:	660 boxes, 7 DVDs, and 1 box of microfiche	3,766	239,804	N/A

4.1 Site Profile Technical Basis Documents (TBDs)

A Site Profile provides specific information concerning the documentation of historical practices at the specified site. Dose reconstructors can use the Site Profile to evaluate internal and external dosimetry data for monitored and unmonitored workers, and to supplement, or substitute for, individual monitoring data. A Site Profile consists of an Introduction and five Technical Basis Documents (TBDs) that provide process history information, information on personal and area monitoring, radiation source descriptions, and references to primary documents relevant to the radiological operations at the site. The Site Profile for a small site may consist of a single document. As part of NIOSH's evaluation detailed herein, it examined the following TBDs for insights into INL operations or related topics/operations at other sites:

- *Idaho National Laboratory and Argonne National Laboratory-West – Introduction*, ORAUT-TKBS-0007-1, Rev. 03; March 12, 2010; SRDB Ref ID: 79862
- *Idaho National Laboratory and Argonne National Laboratory-West – Site Description*, ORAUT-TKBS-0007-2, Rev. 04; August 2, 2010; SRDB Ref ID: 84106
- *Idaho National Laboratory and Argonne National Laboratory-West – Occupational Medical Dose*, ORAUT-TKBS-0007-3, Rev. 02; December 21, 2009; SRDB Ref ID: 77829
- *Idaho National Laboratory and Argonne National Laboratory-West – Occupational Environmental Dose*, ORAUT-TKBS-0007-4, Rev. 02; January 8, 2010; SRDB Ref ID: 78635
- *Idaho National Laboratory and Argonne National Laboratory-West – Occupational Internal Dose*, ORAUT-TKBS-0007-5, Rev. 03; March 2, 2010; SRDB Ref ID: 79571
- *Idaho National Laboratory and Argonne National Laboratory-West – Occupational External Dose*, ORAUT-TKBS-0007-6, Rev. 03; April 19, 2011; SRDB Ref ID: 94104

4.2 ORAU Technical Information Bulletins (OTIBs) and Procedures

An ORAU Technical Information Bulletin (OTIB) is a general working document that provides guidance for preparing dose reconstructions at particular sites or categories of sites. An ORAU Procedure provides specific requirements and guidance regarding EEOICPA project-level activities, including preparation of dose reconstructions at particular sites or categories of sites. NIOSH reviewed the following OTIBs and procedures as part of its evaluation:

- *OTIB: Internal Dosimetry Organ, External Dosimetry Organ, and IREP Model Selection by ICD-9 Code*, ORAUT-OTIB-0005 Rev 05; December 20, 2012; SRDB Ref ID: 121336
- *OTIB: Dose Reconstruction from Occupational Medical X-Ray Procedures*, ORAUT-OTIB-0006, Rev. 04; June 20, 2011; SRDB Ref ID: 98147
- *OTIB: Technical Information Bulletin: Tritium Calculated and Missed Dose Estimates*, ORAUT-OTIB-0011 Rev 00; June 29, 2004; SRDB Ref ID: 19430

- *OTIB: Assignment of Environmental Internal Doses for Employees Not Exposed to Airborne Radionuclides in the Workplace*, ORAUT-OTIB-0014 Rev 00; June 22, 2004; SRDB Ref ID: 19432
- *OTIB: Bulletin: Interpretation of Dosimetry Data for Assignment of Shallow Dose*, ORAUT-OTIB-0017 Rev 01; October 11, 2005; SRDB Ref ID: 19434
- *OTIB: Internal Dose Overestimates for Facilities with Air Sampling Programs*, ORAUT-OTIB-0018 Rev 01; August 9, 2005; SRDB Ref ID: 19436
- *OTIB: Technical Information Bulletin: Assignment of Missed Neutron Doses Based on Dosimeter Records*, ORAUT-OTIB-0023 Rev 01; May 14, 2008; SRDB Ref ID: 43937
- *OTIB: Application of Internal Doses Based on Claimant-Favorable Assumptions for Processing as Best Estimates*, ORAUT-OTIB-0033 Rev 00; April 20, 2005; SRDB Ref ID: 19457
- *OTIB: Estimating Doses for Plutonium Strongly Retained in the Lung*, ORAUT-OTIB-0049 Rev 01 PC-2; November 29, 2010; SRDB Ref ID: 90666
- *OTIB: Technical Information Bulletin: Fission and Activation Product Assignment for Internal Dose-Related Gross Beta and Gross Gamma Analyses*, ORAUT-OTIB-0054 Rev 02; March 6, 2014; SRDB Ref ID: 130852
- *OTIB: Technical Information Bulletin: Internal Dose Reconstruction*, ORAUT-OTIB-0060 Rev 00; February 6, 2007; SRDB Ref ID: 29984
- *OTIB: Guidance on Assigning Occupational X-Ray Dose under EEOICPA for X-Rays Administered Off Site*, ORAUT-OTIB-0079 Rev 00; January 3, 2011; SRDB Ref ID: 89563
- *OTIB: Technical Information Bulletin: Dose Reconstruction Method for Chronic Lymphocytic Leukemia*, ORAUT-OTIB-0082 Rev 00 PC-1; December 20, 2012; SRDB Ref ID: 121337
- *Procedure: Occupational On-Site Ambient Dose Reconstruction for DOE Sites*, ORAUT-PROC-0060 Rev 01; June 28, 2006; SRDB Ref ID: 29986
- *Procedure: Occupational Medical X-Ray Dose Reconstruction for DOE Sites, Rev 03*, ORAUT-PROC-0061 Rev 03; March 3, 2010; SRDB Ref ID: 79758

4.3 Facility Employees and Experts

To obtain additional information, NIOSH interviewed nine former INL employees:

NOTE: The interviews below are not finalized until they have been reviewed by the interviewees. That process is on-going at the time of the issuance of this evaluation report.

- Personal Communication, 2014a, *Personal Communication with former INL worker*; In-person interview at Idaho Falls, Idaho by NIOSH and SC&A; November 2014; SRDB Ref ID: [141472](#)
- Personal Communication, 2014b, *Personal Communication with former INL worker*; In-person interview, [10:00 A.M.](#) at Idaho Falls, Idaho by ORAU Team, ABRWH, SC&A, and NIOSH; November 17, 2014; SRDB Ref ID: [141476](#)
- Personal Communication, 2014c, *Personal Communication with former INL worker*; In-person interview, [13:45 P.M.](#) at Idaho Falls, Idaho by ORAU Team, ABRWH, SC&A, and NIOSH; November 17, 2014; SRDB Ref ID: [141473](#)
- Personal Communication, 2014d, *Personal Communication with former INL worker*; In-person interview at Idaho Falls, Idaho by ORAU Team, Board, SC&A, and NIOSH; November 18, 2014; SRDB Ref ID: [141475](#)
- Personal Communication, 2014e, *Personal Communication with former INL worker*; In-person interview, [13:15 P.M.](#) at Idaho Falls, Idaho by ORAU Team, Board, SC&A, and NIOSH; November 18, 2014; SRDB Ref ID: [141477](#)
- Personal Communication, 2014f, *Personal Communication with former INL worker*; In-person interview, [11:00 A.M.](#) at Idaho Falls, Idaho by SC&A and NIOSH; November 18, 2014; SRDB Ref ID: [141478](#)
- Personal Communication, 2014g, *Personal Communication with former INL worker*; In-person interview, [17:45 P.M.](#) at Idaho Falls, Idaho by ORAU Team, Board, SC&A, and NIOSH; November 18, 2014; SRDB Ref ID: [141480](#)
- Personal Communication, 2014h, *Personal Communication with former INL worker*; In-person interview at Idaho Falls, Idaho by ORAU Team, SC&A, and NIOSH; November 20, 2014; SRDB Ref ID: [141479](#)
- Personal Communication, 2014i, *Personal Communication with former INL worker*; In-person interview at Idaho Falls, Idaho by ORAU Team and NIOSH; December 11, 2014; SRDB Ref ID: [141471](#)

4.4 Previous Dose Reconstructions

NIOSH reviewed its NIOSH DCAS Claims Tracking System (referred to as NOCTS) to locate EEOICPA-related dose reconstructions that might provide information relevant to the petition evaluation. Table 4-2 summarizes the results of this review. (NOCTS data available as of February 2, 2015)

Table 4-2: No. of INL Claims Submitted Under the Dose Reconstruction Rule	
Description	Totals
Total number of claims submitted for dose reconstruction	1854
Total number of claims submitted for energy employees who worked during the period under evaluation (January 1, 1949 through December 31, 1974). Use the NIOSH-evaluated class timeframe here and below.	1074
Number of dose reconstructions completed for energy employees who worked during the period under evaluation (i.e., the number of such claims completed by NIOSH and submitted to the Department of Labor for final approval).	956
Number of claims for which internal dosimetry records were obtained for the identified years in the evaluated class definition	731
Number of claims for which external dosimetry records were obtained for the identified years in the evaluated class definition	711

NIOSH reviewed each claim to determine whether internal and/or external personal monitoring records could be obtained for the employee. The Computer Assisted Telephone Interviews (CATI) provided some information that is useful for dose reconstruction, including work locations, hours worked, incidents (e.g., fires, radioactive releases, and spills), and hazards encountered. Of the 1,074 claims submitted with employment during the period under evaluation, 731 (68%) have internal monitoring data available and 711 (66%) have external monitoring data available.

4.5 NIOSH Site Research Database

NIOSH also examined its Site Research Database (SRDB) to locate documents supporting the assessment of the evaluated class. There are currently 9,487 documents in this database identified as pertaining to Idaho National Laboratory. These documents were evaluated for their relevance to this petition. The documents include historical background on data types, monitoring, and program descriptions found (e.g., dust sampling, air monitoring, urinalysis data, radiological control program, medical monitoring, process materials, and process description).

4.6 Documentation and/or Affidavits Provided by Petitioners

In qualifying and evaluating the petition, NIOSH reviewed the following document submitted by the petitioner:

The petitioner supplied a signed affidavit on August 29, 2014 (Affidavit, 2014). The affidavit stated: *I affirm that to the best of my knowledge regarding the Idaho National Laboratory that there was no internal monitoring for Plutonium, Neptunium, or Fission Products during the employment years of 1947 to 1970.* [Note: The year 1947 is in error; the INL site began in 1949 and the petitioner-requested class specified 1949 as the starting year.]

5.0 Radiological Operations Relevant to the Class Evaluated by NIOSH

The following subsections summarize both radiological operations at Idaho National Laboratory from January 1949 to December 1970 and the information available to NIOSH to characterize particular processes and radioactive source materials. From available sources NIOSH has gathered process and source descriptions, information regarding the identity and quantities of each radionuclide of concern, and information describing processes through which radiation exposures may have occurred and the physical environment in which they may have occurred. The information included within this evaluation report is intended only to be a summary of the available information.

5.1 Idaho National Laboratory Plant and Process Descriptions

The Idaho National Laboratory was known by several names throughout its history [i.e., National Reactor Testing Station (1949–1973), Idaho National Engineering Laboratory (1974–1996), Idaho National Engineering and Environmental Laboratory (1997–2004), and Idaho National Laboratory (2005–Present)]. For the purposes of this evaluation report, this site will be referred to as the Idaho National Laboratory or INL (with the exception of source document titles) throughout the rest of this evaluation report.

Idaho National Laboratory is an 890-square-mile complex located in the high desert of eastern Idaho, west-northwest of the city of Idaho Falls (Figure 5-1). In 1949, the Atomic Energy Commission (AEC) established the National Reactor Testing Station on the site of a 1940s United States Navy bombing and artillery range. INL was the primary nuclear reactor development laboratory in the United States. Over 100 reactor concepts were conceived and tested there. Between 1953 and 1992,

the Idaho Chemical Processing Plant (CPP) at INL reprocessed spent nuclear fuel from naval propulsion, test, and research reactors to recover enriched uranium for reuse in nuclear fuel and nuclear weapons production. Other facilities at INL also conducted various nuclear weapons research and development activities.



Figure 5-1: INL Location in Idaho

There are six INL operating areas that will be addressed in this evaluation report. Figure 5-2 shows the layout of the INL facilities.

1. Test Reactor Area (TRA) – Section 5.1.1
2. Chemical Processing Plant (CPP) – Section 5.1.2
3. Test Area North (TAN) – Section 5.1.3
4. Misc. Reactor Areas (ARA, OMRE, SPERT) – Section 5.1.4
5. Central Facilities Area (CFA) – Section 5.1.5
6. Burial Ground – Section 5.1.6

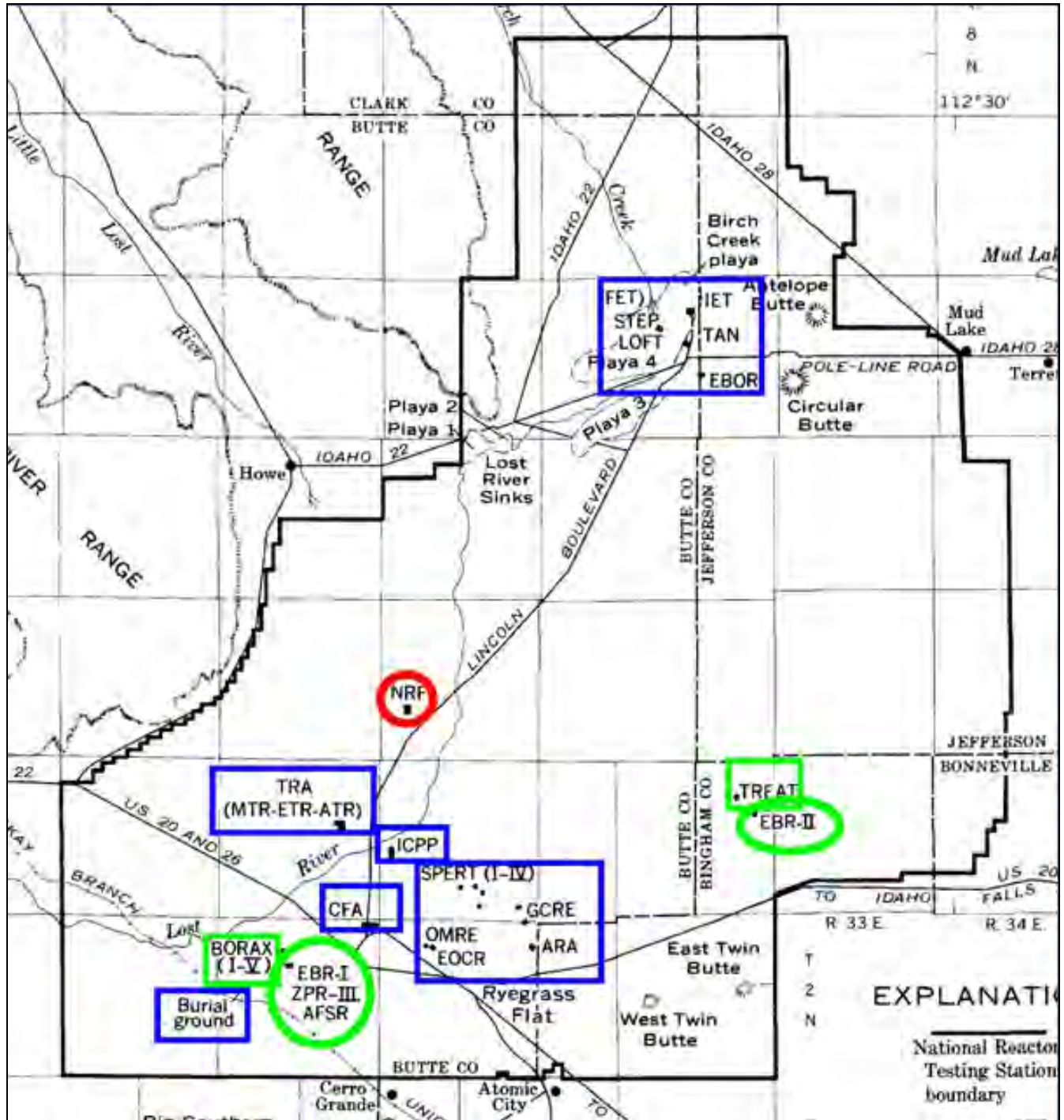
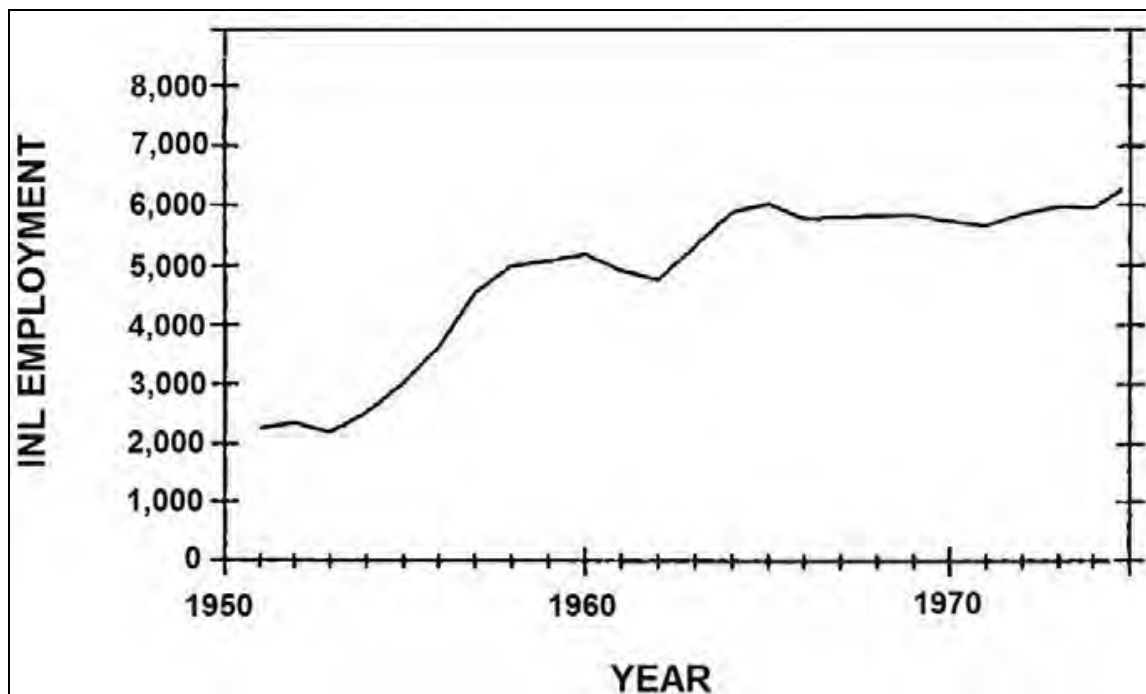

Figure 5-2: Layout of INL Facilities

In Figure 5-2, the blue areas are considered INL, the green areas are considered Argonne National Laboratory-West (ANL-W), and the red is the Naval Reactors Facility (NRF), which is not a covered facility under EEOICPA.

Figure 5-3 shows the employment levels at INL from 1951 through 1975. After reviewing the available INL documentation, NIOSH has concluded that definitive historical site population numbers are elusive. There is no consistent source of employment information and the various sources count employees differently. INL's own historical overview of site exposure history points out that there is little evidence of real effort to identify and preserve historic data. Those INL authors experienced considerable difficulty obtaining total counts before 1974, much less a breakdown by individual contractor (Exposure History, 1993). Most sources count only the AEC and contractor personnel administered by IDO; others may count non-IDO contract employees (e.g., ANL-W), and sometimes visitors are counted. These counts do not appear to include workers employed by minor subcontractors (e.g., construction workers), which only appear to be included when visitors are counted. Counting visitors can greatly expand the population count (e.g., for 1961, from 4,920 to 25,580). Thus, INL employment figures are best viewed as "ballpark" numbers that reflect AEC and primary contractor personnel.



Source: Exposure History, 1993

Figure 5-3: Idaho National Laboratory Employment, 1951-1975

5.1.1 Test Reactor Area (TRA)

ATTRIBUTION: Section 5.1.1 was completed by Mike Mahathy, Oak Ridge Associated Universities. All conclusions drawn from the data regarding the Test Reactor Area were peer-reviewed by the individuals listed on the cover page. The rationale for all conclusions in subsequent sections of this document devoted to the Test Reactor Area are explained in the associated text.

The Test Reactor Area (TRA) is approximately five miles north of the Central Facilities Area. Figure 5-4 shows the location of TRA relative to several other INL operating areas.

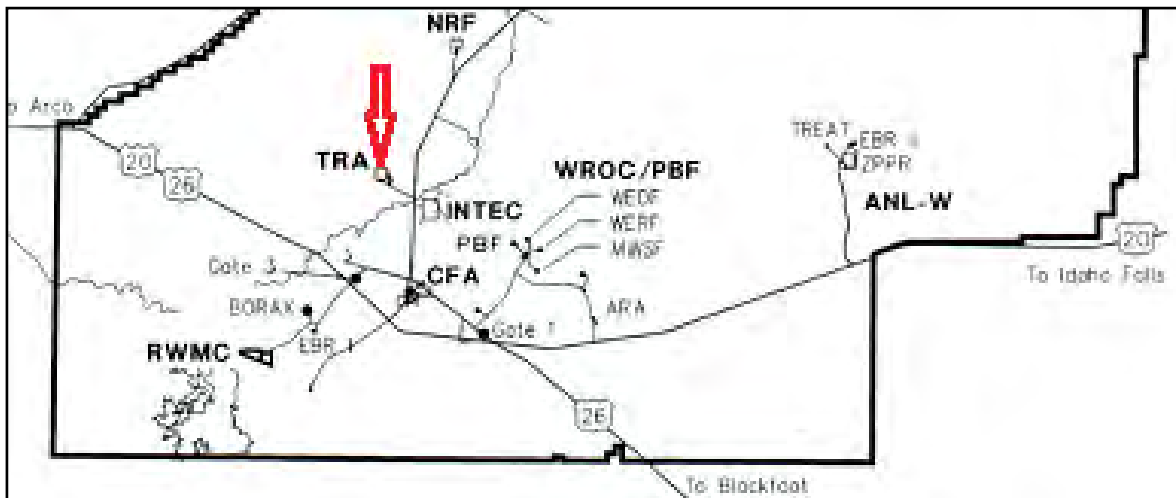

Figure 5-4: Map Location, TRA

Eight reactors were built and operated in the TRA (Stacy, 2000):

- High-flux Reactors Used for Materials Testing
 - Materials Test Reactor (MTR)
 - Engineering Test Reactor (ETR)
 - Advanced Test Reactor (ATR)

- Low-power Reactors Used for Reactivity Measurements
 - Reactivity Measurement Facility (RMF)
 - Advanced Reactivity Measurement Facility No. 1 (ARMF-1)
 - Advanced Reactivity Measurement Facility No. 2 (ARMF-2)
 - Engineering Test Reactor Critical (ETRC)
 - Advanced Test Reactor Critical (ATRC)

Over the course of MTR and ETR operations, more than 250 radionuclides were either irradiated or produced from irradiation. The following support and laboratory facilities were also located in the Test Reactor Area:

- TRA Hot Cells
- Gamma Facility
- Radiation Measurement Laboratory
- Radiochemistry Laboratories
- HB-4 Crystal Spectrometer
- Fast (Neutron) Chopper

All personnel who entered the TRA were required to wear dosimetry badges, and those who worked in or near radiological control areas were issued pocket ionization chambers as well. Personnel who worked in radiological control areas were on a routine bioassay program and received routine whole-body counts. Table 5-1 shows the TRA facilities and their years of first and last use. These facilities are discussed in the following subsections.

Table 5-1: INL Test Reactor Area (TRA) Reactors and Support Facilities

Facility Name	Building No.	First Used	Last Used	Facility Type
Materials Test Reactor (MTR)	TRA-603	1952	1970	Reactor
Engineering Test Reactor (ETR)	TRA-642	1957	1981	Reactor
Advanced Test Reactor (ATR)	TRA-670	1967	In use	Reactor
Reactivity Measurement Facility (RMF)	TRA-603	1954	1962	Reactor
Advanced Reactivity Measurement Facility No. I (ARMF-I)	TRA-660	1960	1974	Reactor
Advanced Reactivity Measurement Facility No. 2 (ARMF-II); renamed Coupled Fast Reactivity Measurement Facility (CFRMF)	TRA-660	1962	1991	Reactor
Engineering Test Reactor Critical Facility (ETRCF)	TRA-654	1957	1982	Reactor
Advanced Test Reactor Critical Facility (ATRC)	TRA-670	1964	In use	Reactor
Hot Cell Facility	TRA-632	1954	In use	Research
Gamma Facility	TRA-641	1955	ND	Research
Radiation Measurement Laboratory (RML)	TRA-604	1952	In use	Sampling/ Research
Radiochemistry Laboratories	TRA-604	1950	In use	Sampling/ Research
Alpha Laboratories	TRA-652	1961	1970	Sampling/ Research
HB-4 Crystal Spectrometer	TRA-603	1952	1970	Research
Fast (Neutron) Chopper	TRA-665	1952	1970	Research

ND = Date of last use not determined

Figure 5-5 shows an aerial view of the Test Reactor Area taken in 1956. The large building in the left foreground is the MTR building; the large building to the right in the background is the ETR Building. The attached wing at the bottom contains the Alpha Laboratories.



Figure 5-5: Test Reactor Area (TRA) Complex, 1956

5.1.1.1 Materials Test Reactor (MTR)

The MTR was the original reactor at the TRA and the second reactor to be operated at INL. This water-cooled, water-moderated reactor used enriched uranium fuel and used beryllium and graphite as a reflector. Fuel assemblies were plate-type and fabricated from aluminum (Stroschein, 1967). The MTR operated at a power level of 30 megawatts until September 1955, when output was increased to 40 megawatts. It supplied a high-neutron flux in support of a reactor development program that irradiated potential reactor fuels and structural materials (Stacy, 2000). Shielding was used to prevent personnel exposures from neutron and gamma radiation.

The MTR was designed to test concepts and designs for future reactors. The high density of epithermal neutrons in the MTR permitted the extension of the practical range of the crystal spectrometer to higher neutron energy ranges. The properties of fissionable isotopes in the lower-resonance energy regions could be investigated and their nuclear constants more accurately determined. The MTR provided the opportunity for reactions of higher order with the capture of two or more neutrons in succession by the same nucleus in significant quantities of rare isotopes, thereby permitting the study of their nuclear constants. Production of radioisotopes in amounts and of specific activities previously not readily available was done with the MTR. Tests of potential nuclear fuels

were conducted under simulated operating conditions of temperature, pressure, and environmental factors (Stroschein, 1967).

The design of the MTR provided researchers with several options for sample irradiation. Pneumatic ports on the reactor top enabled the insertion of capsules for irradiation into a graphite region around the core. A hydraulic rabbit system underneath the reactor enabled the insertion of specimens and their discharges to the canal during reactor operation. Horizontal and angular beam holes made it possible to perform cross-section measurements and other physics research experiments (Figure 5-6). A component, referred to as a discharge chute, was installed in the reactor vessel and used to discharge spent fuel assemblies, control rods, irradiated slugs, and components to the canal (Stroschein, 1967). The high-flux radiation fields available in the MTR made it possible to accelerate the screening of test materials. The MTR contributed to the design of various types of reactors, including pressurized-water, organic-moderated, liquid-metal-cooled, and others (Stacy, 2000, PDF p. 279).

In August 1958, the MTR became the first reactor to operate using Pu-239 as fuel with about 4 kg Pu-240 as a convertible poison (Keller, 1958a). The MTR was again fueled with Pu-239 with 5.6 kg Pu-240 in 1970 for limited experiments as part of the Hanford Phoenix Fuel Program (Hofmann, 1965; MTR, 1967; Davis, 1970). The plutonium cores demonstrated that a plutonium-fueled, water-moderated reactor could be controlled satisfactorily. The MTR logged more than 125,000 operating hours in more than 19,000 neutron irradiations. In August 1970, the MTR was again brought to power for a twenty-four hour run to irradiate one thousand biological samples for iodine analysis which was the last operation (Stacy, 2000).



Figure 5-6: Inserting a Sample Rabbit in a Beam Port

The MTR reactor building was built to enclose the reactor structure and canal. It also furnished space for experimental facilities on the main floor level and in the basement. The control room, operations personnel offices, and electrical equipment were housed on two balconies above the main floor. The building was designed to operate at a positive pressure of 1-1/2 in. of water to reduce entrance of dust into the building; but, due to building additions and increased use of ventilating air, atmospheric pressure prevailed by 1967 (Stroschein, 1967). Building air was drawn through filters into the reactor structure and was used to cool the graphite reflector. Building walls were comprised of pre-cast insulated concrete slabs bolted to concrete-encased structural columns. They were designed to be blown outward in the event of a high pressure surge in the building. The flat roof was constructed of pre-cast concrete panels laid on steel purlins covered with foam-glass insulating blocks and other roofing material. The main floor of the reactor building was reinforced concrete. The floor area immediately surrounding the reactor structure was three feet thick; the floor surrounding this area and extending to the building wall was one foot thick.

Figure 5-7 shows a vertical section diagram of the MTR reactor through the north-south centerline looking west.

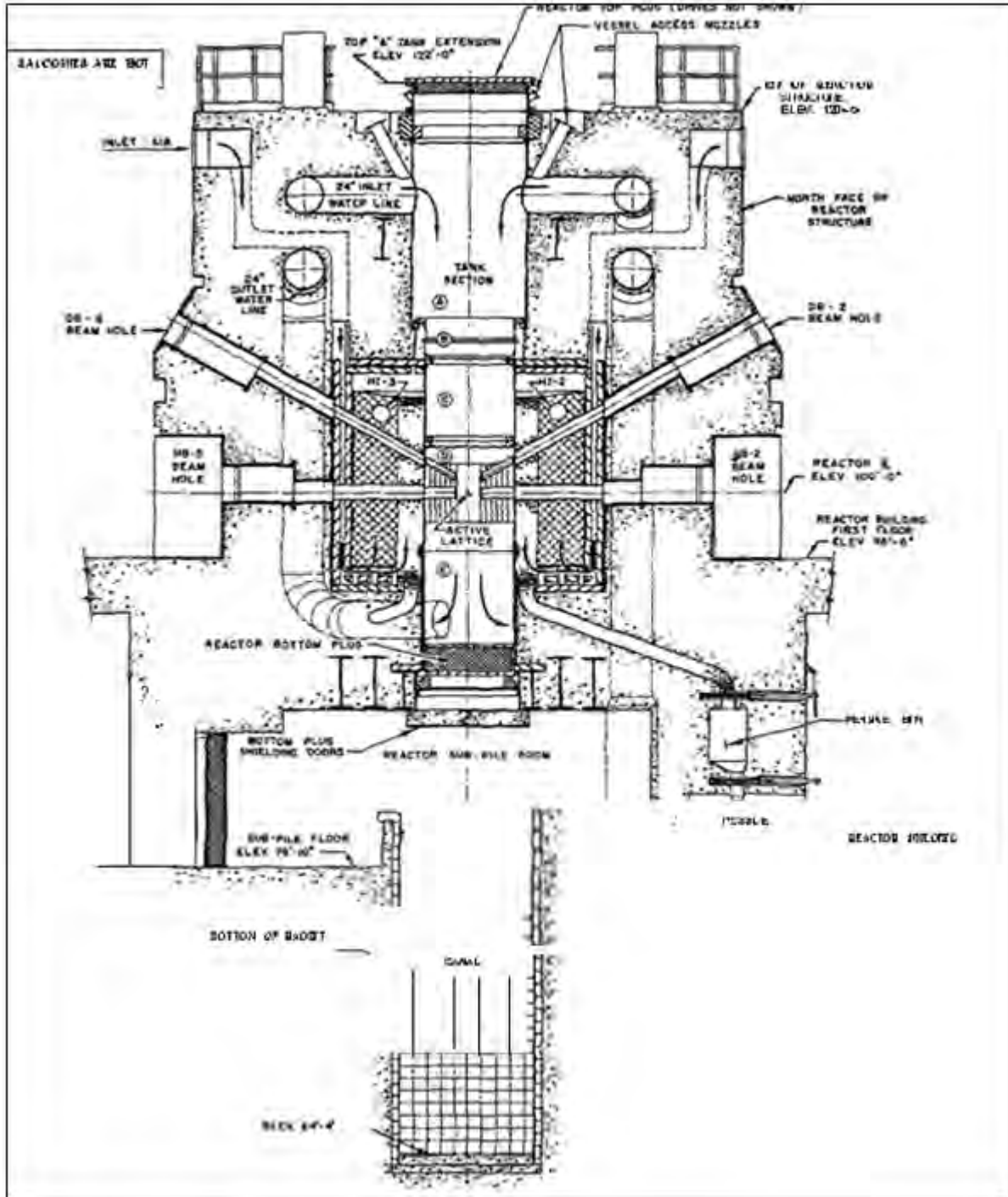

Figure 5-7: MTR Vertical Section Diagram (North-south Centerline Looking West)

A canal was designed and constructed as a shielding medium. The use of water in a canal arrangement allowed for direct visual contact of radioactive components, and facilitated the use of simple tools in the handling of those components. The canal contained equipment for handling the assemblies discharged from the reactor. The canal provided space for storage of spent fuel assemblies, irradiated materials, and internal reactor parts. The canal walls were originally covered with 8 in. by 16 in. white glazed structural tile four-inches thick. The bottom was lined with four inches of white concrete. A stainless steel liner was added after excessive leakage was experienced. A flow of 20 gallons per minute of de-mineralized water was maintained through the canal to avoid an excessive build-up of radioactivity and turbidity. With the original construction, water from the canal overflowed a weir in the east end of the canal and flowed through a discharge pipe to the canal sump. However, in time, an overflow pipe was installed west of the canal isolation gate. The use of the overflow weir was discontinued (Stroschein, 1967). Figure 5-8 shows the canal.



Figure 5-8: A Portion of the MTR Canal

There was considerable maintenance work performed on the canal during shutdowns. This work required constant monitoring by Health Physics. The spread of contamination was a constant hazard during canal work; Health Physics staff was trained to recognize conditions that could have possibly caused contamination and the steps to prevent it (Stroschein, 1967). Health Physics logbooks that are available to NIOSH demonstrate the oversight of canal operations.

5.1.1.2 Engineering Test Reactor (ETR)

The ETR was designed and constructed for performing engineering tests of fuel elements and nuclear plant components. It was placed into operation in 1957. At that time, the ETR was the largest and most advanced nuclear materials test reactor in the world. The ETR provided larger test spaces than the MTR and a more intense neutron flux. ETR fuel, coolant, and moderator materials were evaluated under environments similar to those of power reactors. Several experimental loop facilities were designed to test fuels for the Aircraft Nuclear Propulsion (ANP) project and the U.S. Navy's fuel development program.

The ETR reactor building was 136 feet long and 112 feet wide. It extended 58 feet above grade and 38 feet below grade to the basement floor. The high bay area above the first floor had a clear height of 47 feet to the bottom of the roof truss structure. The first floor was at the same floor elevation as the MTR main floor. A photo of the reactor housing shown from the first floor showing clean conditions is given in Figure 5-9.

The ETR canal extended westward from the reactor structure. The process-water-pipe tunnel extended eastward from the reactor structure under the first floor. The console floor was about 22 feet below the main floor and served a dual purpose as a shielding roof for experimental cubicles at basement level, and as a working level for experimental consoles and equipment. The walls of the pipe tunnel, the biological shield, and the canal walls extending from the first floor to the console floor divide the console area into halves connected only at the west end by a 9-foot 6-inch wide corridor. The basement floor was approximately 38 feet below the main floor resting on compacted fill (Stroschein, 1967).

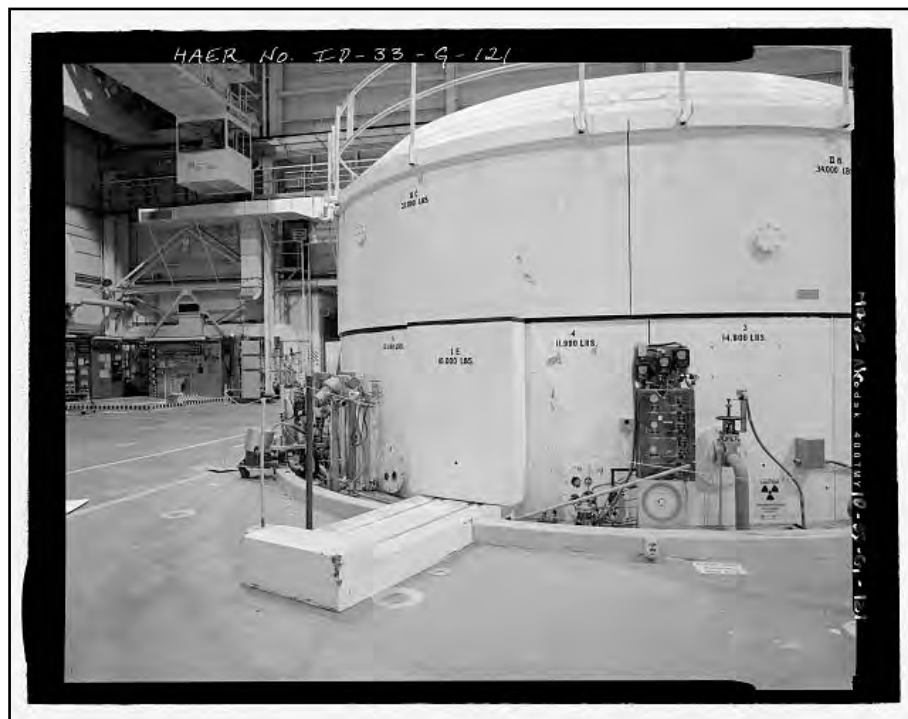

Figure 5-9: ETR Reactor

A working canal provided ample working room for removal of experiments from the reactor tank. Fuel elements and experimental sections were transferred from the reactor into the working canal through the discharge chute in the reactor vessel transition piece. That was accomplished by lowering the fuel element into a transfer tube located in the canal under the discharge chute. The transfer tube (which was hydraulically operated) was pivoted to permit an operator to secure the element from the canal by a hook tool. The operator then led the element to the storage racks. Fuel elements had a tendency to float when transferred through the water with any speed, which presented an additional radiation hazard. The canal working platform was permanently attached to the east end of the canal parapet allowing access to the working area of the canal immediately over the reactor transfer tube. The platform was constructed in two sections on either side of the canal with an open working area in between the sections. Each section was served with a stairway from the first floor. An underwater saw was located on the south wall of the working canal to cut off fuel element end-boxes and to cut in-pile piping into disposable lengths. A capsule reloading tray, flux wire storage grid, and an underwater periscope used for capsule inspection were located by the south canal wall (Stroschein, 1967).

The storage canal had storage space for irradiated fuel slugs, experimental equipment, fuel elements, and reactor core components. This storage was laid out by alphabetical grids. The north half of the storage canal was designated for storage of non-fissionable core components while fuel assemblies were stored in cadmium-lined storage grids. Spent fuel elements were stored in 36-hole, cadmium-lined storage grids to cool before being cut and shipped to either the Gamma Facility or the Chemical Processing Plant. The south half of the canal storage area was used for storing long in-pile loop experimental samples and other bulky items (Stroschein, 1967).

There was potential for external exposure to workers in the reactor area during shutdown, during changes of loop, and as experiment samples were taken.

Potential for internal exposure from airborne fission products was minimal during normal reactor operation. There was some potential for internal exposures during shutdown because airborne fission products were often released when the reactor top was removed. There was also some potential for internal exposure from activation products during maintenance work in the reactor subpile room and in the experiment cubicles.

5.1.1.3 Advanced Test Reactor (ATR)

The ATR is the newest materials testing reactor to be built in the Test Reactor Area, going into service in July 1967; it is still operational. Its design is based on ideas developed through use of the MTR and ETR. The ATR simulates the environment in a power reactor to study the effect of radiation on steel, zirconium, and other materials. The reactor produces an extremely high neutron flux that makes it ideal for materials testing. Target materials are exposed to the neutron flux to test their durability in an environment of high temperature, high pressure, and high gamma fields. Data that normally would require years to gather from ordinary reactors can be obtained in weeks or months from the ATR.

The ATR can operate up to a power level of 250 MW. Its unique four-lobed design can deliver a wide range of power levels to nine main test spaces or loops. Each loop has its own distinct environment apart from that of the main reactor core. Smaller test spaces around the loops enable additional tests. The ATR also produces radioisotopes for use in medicine, industry, and other research (Stacy, 2000, PDF p. 274).

The ATR is located in the northwest portion of the Test Reactor Area complex. Figure 5-10 shows a modern-day aerial photo of the ATR complex. The reactor building covers an area of approximately 200 feet by 200 feet, while the substructure extends approximately 60 feet below grade.



Figure 5-10: Advanced Test Reactor Complex (ATR in Center)

On the ground floor, the ATR reactor room is 88 feet by 100 feet and occupies the south central portion of the building (Figure 5-11).

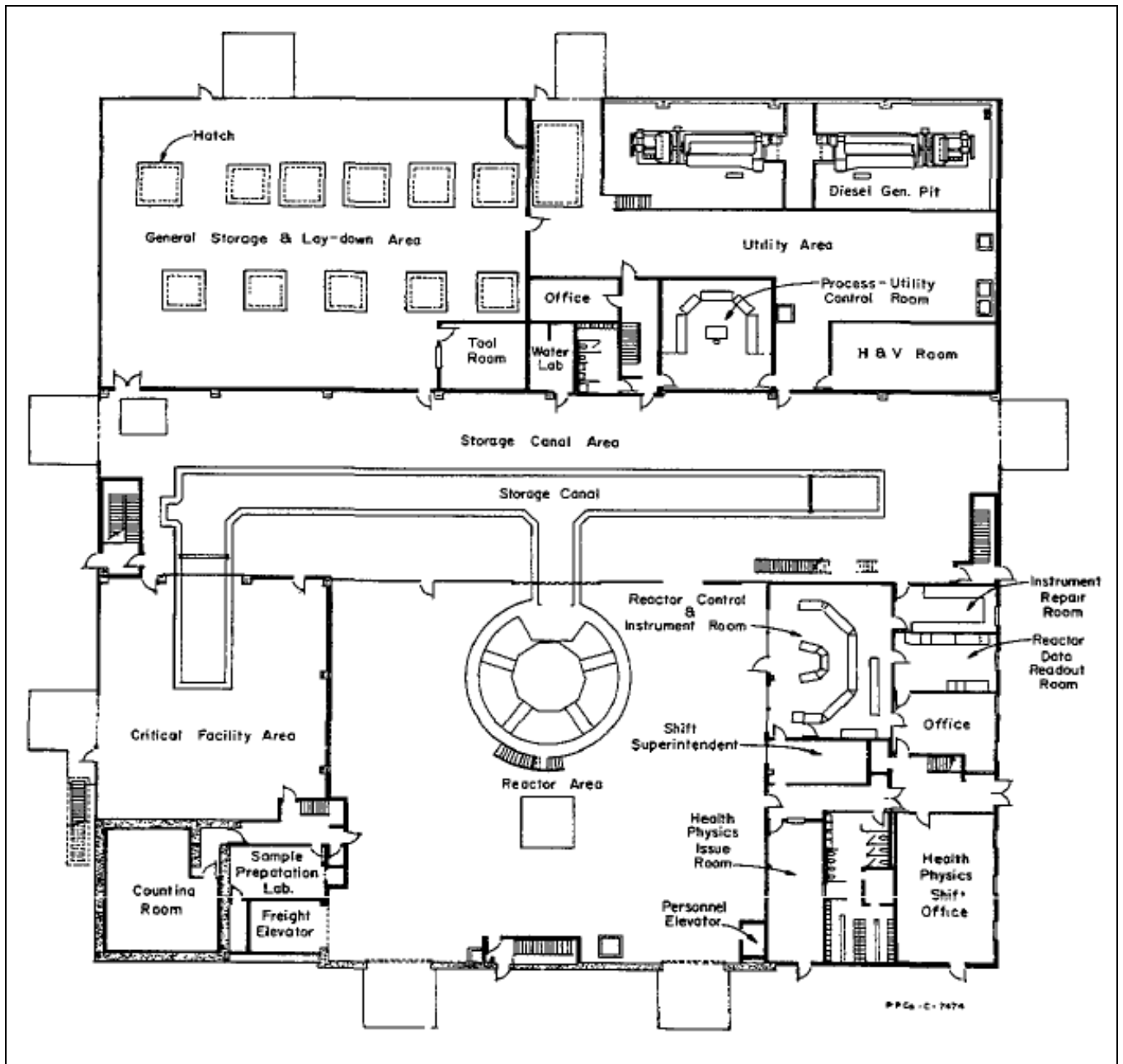

Figure 5-11: ATR Ground Floor

5.1.1.4 Reactivity Measurement Facility (RMF)

The Reactivity Measurement Facility (RMF) was a very-low-power reactor in the east end of the MTR canal that operated at a power level of 100 or 200 W. It was installed in August 1954 and placed in use by the end of 1954 (Notes, 2015). Water was used as the moderator, reflector, and shield. The RMF was designed to measure reactivity changes in materials irradiated in the MTR or ETR. The RMF was used to assay new and spent fuel elements and to assist in experiment scheduling by evaluating reactivity losses and flux depression caused by in-pile apparatus (Stacy, 2000, PDF p. 280). Figure 5-12 shows the RMF over the top of the MTR canal. It was replaced with the Advanced Reactivity Measurement Facility No. 1.

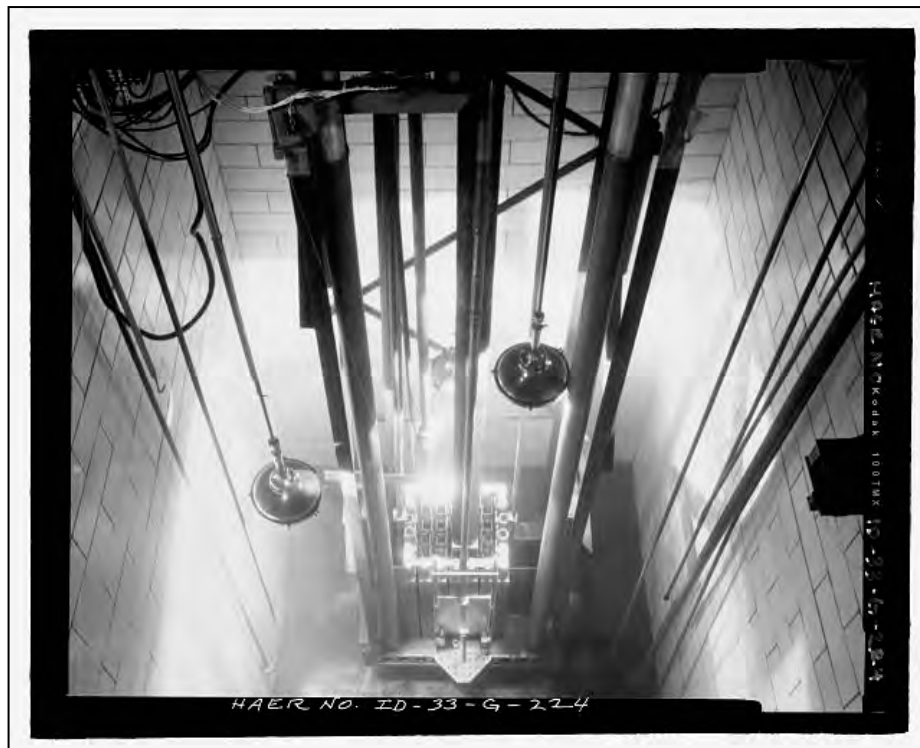

Figure 5-12: Radiation Measurement Facility

Specific RMF applications included precision measurements of reactivity that were employed when investigating: gross fission-product cross-section as a function of operating time in a high-flux reactor; fuel burn-up and burnable poison studies; and determination of pile cross-sections and resonance integrals of special materials (e.g., zirconium alloys, dysprosium, and hafnium). The RMF measured the rate of U-233 build-up in thorium after MTR irradiation. The high cross-section fission product Xe-135 was readily observed as it was formed by decay of I-135, and subsequently, as it disappeared by decay to Cs-135 (Phillips, 1962).

5.1.1.5 Advanced Reactivity Measurement Facility No. 1 (ARMF-I)

ARMF-I was a small pool reactor in Building TRA-660 located east of the MTR. It was used to determine the nuclear characteristics of reactor fuels and other materials for testing in the MTR. ARMF-I operated from October 1960 through 1974 (Stacy, 2000, PDF p. 274).

5.1.1.6 Advanced Reactivity Measurement Facility No. 2 (ARMF-II)

ARMF-II was a pool reactor in the opposite end of the tank occupied by ARMF-I. It was originally installed to complement the capability to measure nuclear characteristics. It was placed into operation in December 1962. ARMF-II had a readout system that recorded measurements on data cards, resulting in timelier data processing (Stacy, 2000, PDF p. 274). The ARMF-II reactor was modified in 1968 and renamed the Coupled Fast Reactivity Measurement Facility (CFRMF). The core was modified to produce a region of high-energy neutron flux to provide physics information about the behavior of fast (un-moderated) neutrons. Physicists studied differential cross-sections and tested calculation methods. The facility contributed to the development of fast-neutron reactors (Stacy 2000, PDF p. 275). This reactor was operated until 1991.

5.1.1.7 Engineering Test Reactor Critical Facility (ERTC)

The Engineering Test Reactor Critical Facility was a full-scale, low-power nuclear copy of the ETR. It performed functions similar to those of ARMF and the Advanced Test Reactor Critical Facility (ATRC) (discussed below). It was used to determine the nuclear characteristics of fuel and experiments planned for irradiation in ETR, and the power distribution effects for a given ETR fuel and experiment loading. ETRC enabled operators to predict the nuclear environment when completed experiments were removed or new experiments were added. The information was necessary to calculate the experiment irradiation and determine core life, control rod withdrawal sequences, reactivity worth, and core safety requirements. Mockups of fuel and experiment loadings in ETRC were manipulated until a desired power distribution throughout the core was attained, satisfying pertinent safety requirements. The ETRC was operated from 1957 through 1982 (Stacy, 2000, PDF p. 276). Figure 5-13 shows a photo of the ETRC.

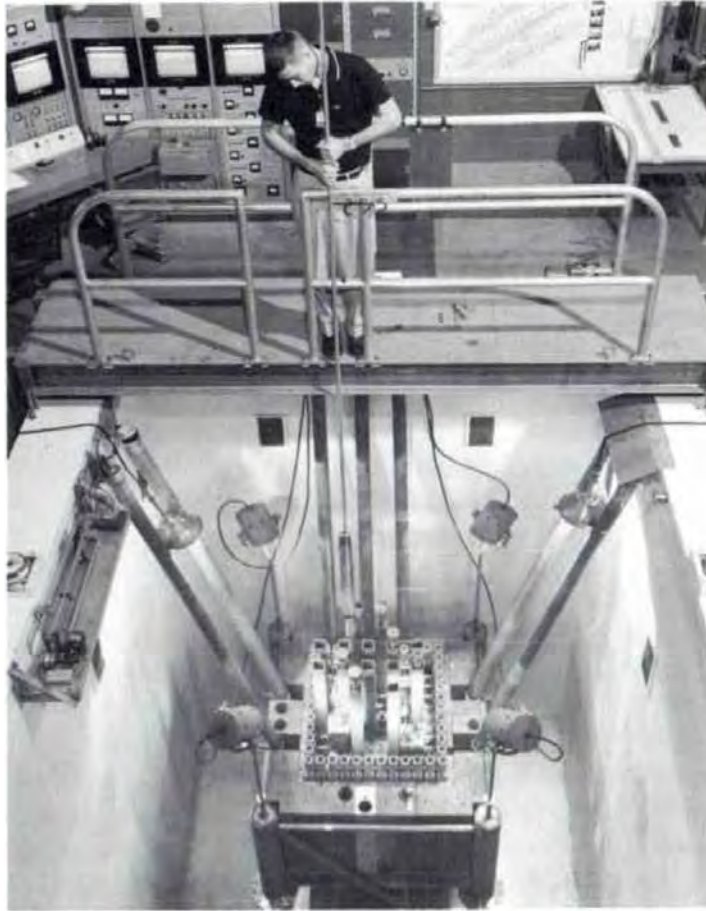

Figure 5-13: The Engineering Test Reactor Critical Facility (ETRC)

5.1.1.8 Advanced Test Reactor Critical Facility (ATRC)

The ATRC performs functions for the ATR similar to those performed by the ARMF reactors for the MTR. ATRC verified for reactor designers the effectiveness of control mechanisms and physicists' predictions of power distribution in the large core of the ATR. Low-power testing in the ATRC conserved time so that the large ATR could irradiate experiments at high power levels. The ATRC also verified the safety of a proposed experiment before it was placed in the ATR. The ATRC was placed into operation in 1964 and is still operational (Stacy, 2000, PDF p. 274).

5.1.1.9 Hot Cell Facility

The TRA's Hot Cell Facility is located in the southwest portion of the ETR building. The Hot Cell Facility was first used in 1954 (Stacy, 2000). The building is no longer used for radiological operations (DOE, 2009). The facility consisted of three separate cells with a common operating corridor. The hot cells were designed and built for the examination of materials exposed to neutron bombardment. Processes that were contained in the hot cells included gamma scanning, photography, and optical metallography used for handling, photographing, milling, measuring, and weighing radioactive samples (DOE, 2009; Stacy, 2000). Each hot cell contained equipment, including lathes, power saws, grinders, and welders. There were also stainless steel tables and other fixtures in the cells. The hot cells were also used to produce radioisotopes (DOE, 2009). The hot cells were constructed as follows.

- Cell #1 (Figure 5-14) was designed for working with high-dose-rate irradiated materials. The walls were constructed of nominally 4-ft.-thick high-density concrete, lined on the interior with 1/4-in. painted carbon steel plate to provide adequate workers shielding.
- Cell #2 (Figure 5-15) was used for working with lower-dose-rate materials. The walls of this cell were formed from ordinary concrete 2-ft-9-in. thick. Floor and lower walls were lined with 1/4-in. carbon steel plate. Cell #2 could be divided into two equal-sized subcells by means of a 6-in.-thick motor-driven steel door which could be slid horizontally on a floor track. Cell #2 and its surrounding work area are shown in an overhead photo in Figure 5-16.
- Hot Cell #3 was completed in 1960 to increase the capacity of the facility; it is located on the west end of TRA-632 building. Hot Cell #3 was also used for working high-dose-rate materials. The south and west walls were constructed of 5-ft-6-in.-thick ordinary concrete; the remaining walls were constructed of 4-ft-thick high-density concrete. The floor and lower walls (to 6 ft above the floor) are lined with 1/4-in. carbon steel plate. There were four viewing windows on the north wall and one viewing window on the east wall. This cell could also be divided into east and west subcells using a 6-in.-thick motor-driven steel door as at Cell #2 (DOE, 2009).

The layout of the cells along with offices and other areas is shown in Figure 5-17.



Figure 5-14: TRA Hot Cell #1



Figure 5-15: TRA Hot Cell #2

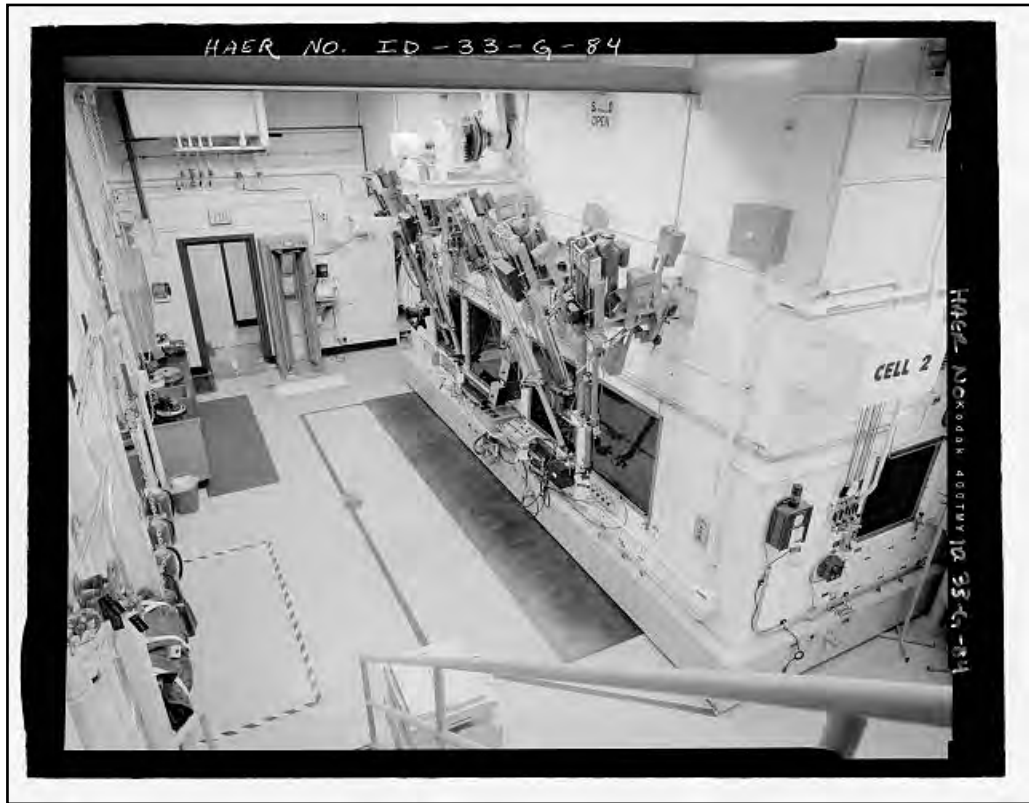

Figure 5-16: TRA Hot Cell #2

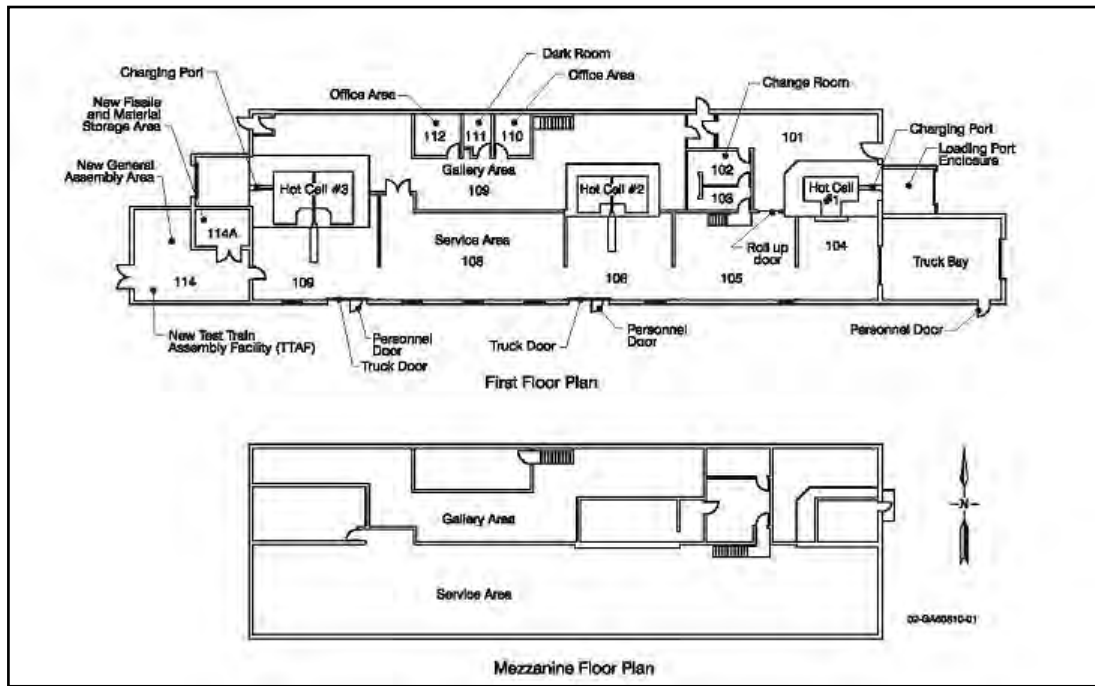

Figure 5-17: TRA Hot Cell Building, Internal Layout

5.1.1.10 TRA Gamma Facility

The TRA Gamma Facility was located to the south of the original TRA main security gatehouse. The facility consisted of a 16-foot-deep canal with cadmium buckets designed to hold spent MTR fuel elements. Experimental samples were inserted in sample tubes and then lowered into extremely high gamma fields. Sponsors provided a large variety of materials and samples for gamma irradiation, including food products and some natural substances such as gold, diamonds, and oil. Irradiated samples not radioactive were surveyed thoroughly for external contamination on removal (Stacy, 2000, PDF p. 126). The Gamma Facility was first operated in 1955; it is no longer operated; the date of last use is not determined.

5.1.1.11 Radiation Measurement Laboratory (RML)

The Radiation Measurement Laboratory, located in the MTR west wing and in use since 1952, was previously called the MTR Counting Room. The RML specializes in measuring quantity and quality of alpha, beta, gamma, and neutron radiation samples. A variety of counting equipment and spectrometers are available in the RML. Over the years, an endless variety of samples have been brought for analyses. Some of the detector shielding was made of pre-World War II battleship steel. The original equipment has been replaced with more modern equipment. R. L. Heath developed the Scintillation Spectroscopy Gamma-Ray Spectrum Catalogues using the capabilities of the RML (Conner, 1956; AEC, 1970).

5.1.1.12 Radiochemistry Laboratories

The Radiochemistry Laboratories, located in the MTR west wing, are used to support RML and independent research and development work. Investigators study methods for producing and purifying medical radioisotopes as well as the effects of radiation on hazardous waste. Originally, Laboratories 109 to 112 were used primarily for chemical analysis of reactor primary systems and loop experimental coolants. The predominant radioactivity has been from fission and activation products. Figure 5-18 shows a photo of Lab 110.

The south extension to the MTR Wing was the Alpha Laboratories, which were designed for the safe handling of actinides, including Pu-239, Am-241 and Cm-244, and other hazardous alpha-emitters, such as Th-232, U-233, and U-235 (Stacy, 2000). Figure 5-19 shows Alpha Lab 127. Figure 5-20 shows an INL scientist machining thorium in an enclosed glove box in one of the alpha labs in 1964. Non-alpha-emitters but with high gamma radiation, such as Pa-233, were sometimes handled in the Alpha Laboratories (see Figures 5-20 and 5-21).



Figure 5-18: Lab 110, MTR Laboratory Wing

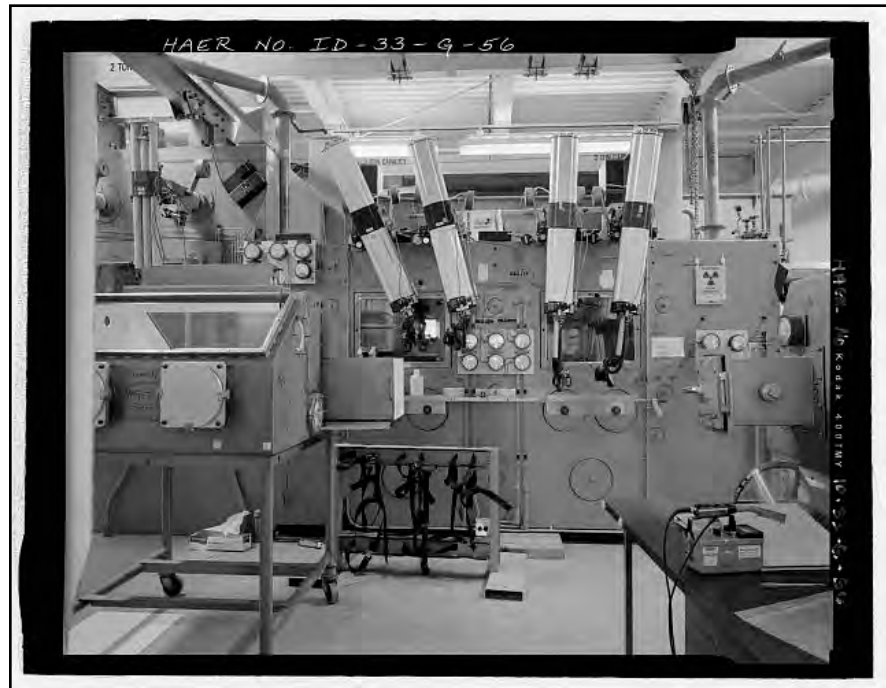

Figure 5-19: Alpha Lab 127, MTR Laboratory Wing



Figure 5-20: Scientist Machining Thorium, Alpha Lab, 1964

Radioisotopes were transferred to this area for analysis or chemical processing in sealed vessels. These vessels were packed in cans at the point of origin, which included off-site entities and INL entities, such as CPP. Cans were mostly opened in one of the fume hoods where the inner container was placed in a clean beaker, still unsealed. The beaker was inserted into an appropriate dry box where the container were unsealed, if necessary. There were two types of dry boxes: (1) one type handled small quantities of radioisotopes that were not emitting very much gamma radiation into the glove box; and (2) the other type was used to work with gamma-emitting radioisotopes in large quantities. That type of dry box was placed in the large cave facility that used mechanical manipulators for handling (Stroschein, 1967).

A stand-alone, highly-shielded hot cell structure was constructed in one of the Alpha Labs in 1961 for working with high-activity actinides, other alpha radionuclides, and high gamma-emitting radionuclides. This structure was referred to as the "Alpha Cave." For example, researchers separated Am-241 from plutonium in 1962 in the Alpha Cave. A special cask was fabricated to load and unload radioactive materials to and from the Alpha Cave (Mahathy, 2015). The alpha cave was operated by manipulators, viewports, and remote camera. INL scientists for the first time prepared a pure form of the highly-radioactive isotope protactinium-233 in the cave. Figure 5-21 shows part of that operation.



Figure 5-21: Preparation of Pure Pa-233, Alpha Cave

5.1.1.13 HB-4 Crystal Spectrometer

The MTR had several experimental holes placed directly adjacent to the active lattice serving as horizontal beam holes (Stroschein, 1967).

The crystal spectrometer occupied the cubicle at beam port HB-4. The spectrometer was used to produce a beam of monoenergetic neutrons with wave properties. The atoms in the crystal were arranged in an orderly array. When a neutron beam struck the crystal, the atoms of the crystal acted as scattering centers. The scattered waves interfered with one another by either reinforcing or cancelling each other according to their relative phases (Stroschein, 1967). These beams were used to measure relative fission product yields (Phillips, 1962).

5.1.1.14 Fast (Neutron) Chopper

In order to measure neutron cross-sections of irradiated radionuclides, the Fast Chopper Facility was constructed. It used the high-neutron flux available in the MTR for the determination of the cross-sections of numerous isotopes of elements. Using beam port HB-6, two shutters controlled the reactor beam, directing it through the MTR building to the Fast Chopper. The Fast Chopper building was heavily shielded, allowing personnel to work in the vicinity of the chopper for short periods of time during reactor operation (Stroschein, 1967). Use of the Fast Chopper was discontinued with the use of the MTR.

5.1.2 Chemical Processing Plant (CPP)

ATTRIBUTION: Section 5.1.2 was completed by Jason Davis, Oak Ridge Associated Universities. All conclusions drawn from the data regarding the Chemical Processing Plant were peer-reviewed by the individuals listed on the cover page. The rationale for all conclusions in subsequent sections of this document devoted to the Chemical Processing Plant are explained in the associated text.

Construction of the Fuel Reprocessing Complex at the Chemical Processing Plant started in 1950 with the Bechtel Corporation serving as construction contractor and American Cyanamid Company as operating contractor. After three years of construction activity and extensive testing, the plant was ready to handle its first load of irradiated fuel. Phillips Petroleum took over as operating contractor in 1953, shortly after fuel-reprocessing activities became routine.

The core of the original Fuel Reprocessing Complex consisted of seven structures, a pair of deep wells, and a power substation. The complex expanded and, at its peak, consisted of more than 100 facilities and support buildings located on approximately 200 acres. Table 5-2 lists the CPP facilities of concern that are described in the following subsections. Figure 5-22 shows a map of the CPP facilities.

Table 5-2: INL Chemical Processing Plant (CPP) Processing and Support Facilities			
Building Number	Facility Name	First Used	Last Used
CPP-601	Main Processing Building	1953	1992
CPP-602	Laboratory	1952	2009
CPP-603	Fuel Storage Building	1953	Present
CPP-604/605	Waste Disposal Building and Rare Gas Plant	1953	ND
CPP-620	Chemical Engineering Laboratory	1968	ND
CPP-627	Remote Analytical Facility and Multi-Curie Cell	1955	1997
CPP-630	Mass Spectrometry Facility	1956	2009
CPP-631	RaLa Off-Gas Filter Building	1957	1963
CPP-633	Waste Calcining Facility	1963	1981
CPP-637	Process Improvement Facility	1959	ND
CPP-640	Hot Pilot Plant/Headend Process Plant	1963	1981
CPP-709	Eastside Service Waste (ESSW) Monitoring Station	1952	1990
CPP-734	Westside Service Waste (WSSW) Monitoring Station	1960	1989
CPP-1781	High Level Liquid Waste Tank Farm	1951	Present
Multiple	Calcined Solids Storage Facilities (CSSF)	1959-1984 ^(a)	Present

ND = Date of last use not determined

(a) Calcined Solids Storage Facilities were built as needed and put into service as they were completed.

Following the facility descriptions there are process overviews of these operations of concern:

- Overview: Fuel Reprocessing Operations
- Overview: Isotope Recovery
- Overview: Waste Calcination

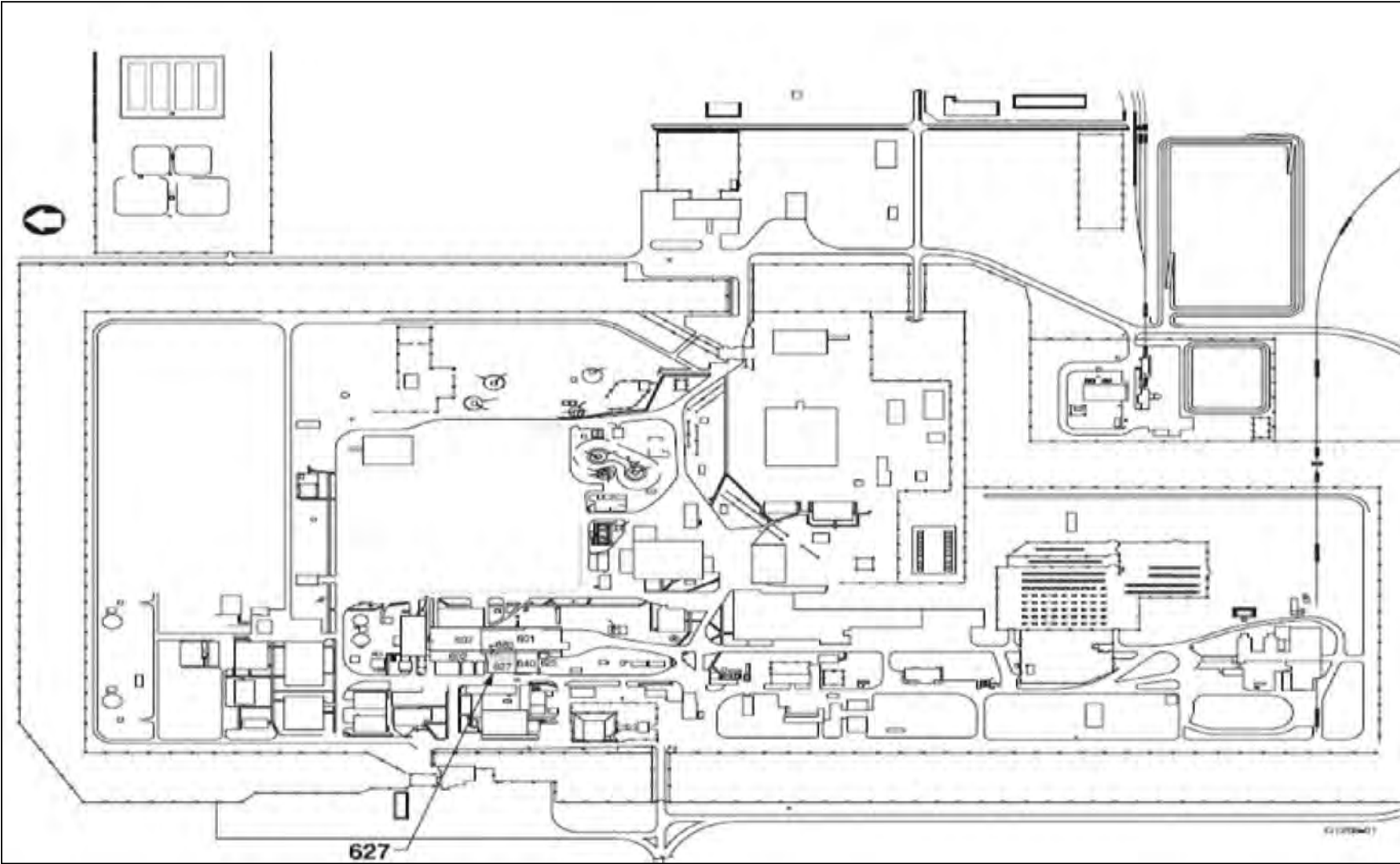

Figure 5-22: Map of CPP Facilities

5.1.2.1 CPP-601, Main Processing Building

The main processing building, CPP-601, which housed the bulk of the processing equipment and controls, was a simple-looking structure with extensive below-ground facilities (see Figures 5-23 and 5-24). It had two levels. The lower level had four stories and was constructed of steel-reinforced concrete. The upper, above-ground level was one story constructed of Transite and structural steel.



Figure 5-23: Locations of CPP-601, CPP-602, CPP-630, and CPP-640

The top story of the building was an un-partitioned space for storage, make-up of chemical solutions, and transfer of fuel elements to the processing equipment below; it was known as the Process Makeup (PM) Area. Below the Process Makeup Area, CPP-601 was divided into a number of corridors and 24 cells.

The 24 cells were arranged in two parallel rows with Operating, Service, and Access corridors extending down the middle. All the equipment for the actual processing of spent fuel elements was contained in these two rows of shielded cells, each uniquely identified by an alphabetic designator. (Rooms housing vacuum equipment, pumps, and tanks were also called cells, although they were usually not given alphabetic designations.) Concrete walls ranging from two- to five-feet thick provided shielding. At the Operating Corridor level, these thick walls were honeycombed with offset pipe sleeves for entrance and exit of utility, process, and instrumentation lines. Most of the equipment within the cells was constructed of stainless steel or other acid-resistant materials. Only one cell (L-Cell) was equipped with a viewing window; for the other cells, the equipment was not visible during operations.

- C-Cell is also located in the west bank of processing cells adjacent to A and B Cells. It is essentially identical to its neighbor, D-Cell, and often worked in tandem with it to dissolve aluminum-alloyed fuels. In 1953, the batch dissolvers in C-Cell and D-Cell processed the first batch of hot fuel introduced into CPP-601. Many more batches of aluminum-alloyed fuel followed this pioneering run (Stacy, 2006).
- D-Cell is a mirror image of C-Cell. Both were originally designed for batch dissolution of fuels with aluminum cladding and each held a complete system for this so-called “headend” process (for removing fuel cladding) (Stacy, 2006).
- E-Cell housed the primary equipment for the original batch zirconium dissolver, made of Monel to resist the corrosiveness of the hydrofluoric acid used to dissolve the zirconium. Another vessel in E-Cell, made of Carpenter-20 steel, was used for the early two-step sulfuric/nitric acid dissolution of fuels clad in stainless steel. The zirconium dissolution equipment was modified several times during its processing history; first, to accommodate semi-continuous processing, and later, to support co-processing with solutions from the aluminum “headend” process. Most of the fuels processed through the E-Cell dissolvers originated with the U.S. Navy, including cores from the Nautilus and Sea Wolf submarines (Stacy, 2006).
- F-Cell floors and walls were lined with stainless steel. After being dissolved in one of two vessels in E-Cell, Navy fuels were sent to geometrically-safe equipment in F-Cell for the first cycle of solvent extraction using tributyl phosphate (TBP). This extraction equipment was last used in 1965 and was largely replaced by a new technology, electrolytic dissolution, housed in CPP-640. After decontamination, F-Cell was modified to serve as a feed clarification system for graphite and aluminum dissolver products. Centrifuges installed in F-Cell at this time were instrumental in removing the solids from these solutions to facilitate uranium extraction (Stacy, 2006).
- G-Cell was one of the busiest cells in the entire plant. This cell housed two continuous dissolvers for aluminum-alloyed fuels plus the large scale first-cycle extraction columns that accepted solutions from many different dissolution systems in the plant. The dissolvers first operated in 1957 and were used again and again until 1986. The G-111 column, which completed the initial cycle of solvent extraction of uranium from a variety of dissolver products without fail for more than twenty years, has been called the “workhorse” of the plant. In addition to myriad runs with dissolved aluminum alloys, in 1969, G-111 would process the first dissolver product from co-processing of zirconium and aluminum. Years later, in 1987 and 1988, the last batch of fuel to be dissolved in CPP-601 would pass through. G-Cell also contained several holding tanks for high-level liquid wastes produced during first-cycle extraction. These raffinates were extremely contaminated both physically and radioactively and could be jetted directly to large 300,000 gallon cooled storage tanks in the CPP Tank Farm (Stacy, 2006).
- H-Cell is located next to G-Cell on the west side of CPP-601. These cells were identical in size and also worked in tandem to process aluminum-alloyed fuels and a first-cycle extraction system for all types of dissolver products from the plant. Generally, H-Cell equipment received the stream of uranium-bearing liquid isolated in G-Cell, processed and purified it further, and sent the resulting high-level liquid waste back to G-Cell for temporary holding. The columns, tanks, and evaporators that processed uranium-bearing solutions in H-Cell are geometrically-unsafe under

some circumstances so operators had to be very mindful of uranium concentrations as solutions were being processed there. Even with strict controls in place, two criticality incidents occurred in the cell during its processing history. The first, in 1961, was centered in an evaporator; the last, in 1978, was in a scrub column. Modifications to the processing equipment, particularly the evaporators, and tighter administrative controls on additions to the process stream, were designed to prevent these types of problems in the future (Stacy, 2006).

- NOTE: No cell within CPP-601 was designated as I-Cell because of the potential for confusion with the number one (1) (Stacy, 2006).
- J-Cell was always devoted to uranium salvage operations. However, it did go through three main changes in configuration during its processing history. Initially, the cell contained a double bank of tanks that continually created problems because they were of insufficient capacity for plant operations. This problem was addressed by installation of a system of fixed nuclear poisons that was intended to increase the capacity of the salvage system without creating criticality problems. These controls did not work as expected and criticality problems did arise. As a result, in its final configuration, the cell was restricted to processing of relatively low-level and low-quantity solutions from the plant's process equipment waste system (Stacy, 2006).
- K-Cell was devoted to recycling operations. Solvents, including both hexone and TBP, were sent to scrubbers and evaporators in K-Cell for decontamination and purification. Uranium separated during this process went back to one of the uranium salvage operations (C, J, and L-Cells) for further purification while the clean solvents were temporarily stored for use at a later time (Stacy, 2006).
- L-Cell arguably became the most complex cell in CPP-601, even though it started out empty and was intended as a spare for future processing activities. Although it started out without a mission, L-Cell did not remain idle for long. Changes began to appear in 1954: a shielded viewing window, remote handling manipulators, a periscope, and intercom system were installed that would allow an operator to see and hear the work going on behind six feet of concrete shielding (see Figure 5-25). A wide variety of equipment also began to appear inside the cell. The equipment included an elevator, two large centrifuges, a dissolver and its charging chute, an off-gas scrubber, and process tanks of many sizes. The set-up that emerged from these changes was designed to isolate an intensively radioactive and short-lived fission product, lanthanum-140 (radioactive daughter of barium-140), from fuel elements fresh from the MTR. By the time most MTR fuel elements reached the CPP processing cells (after at least 120 days of cooling), all of the lanthanum had decayed. However, the fuel brought to L-Cell was new enough that useable quantities of it were still present. When the first usable amounts of this isotope were isolated in L-Cell in 1957, it became known as the RaLa Cell, which was short for the radioactive lanthanum produced there and quickly shipped to Oak Ridge for research. The process continued until 1963. L-Cell remained idle for many years until 1984, when a new critically-safe uranium salvage system was installed to process solutions that were known or suspected to contain recoverable amounts of uranium (Stacy, 2006).

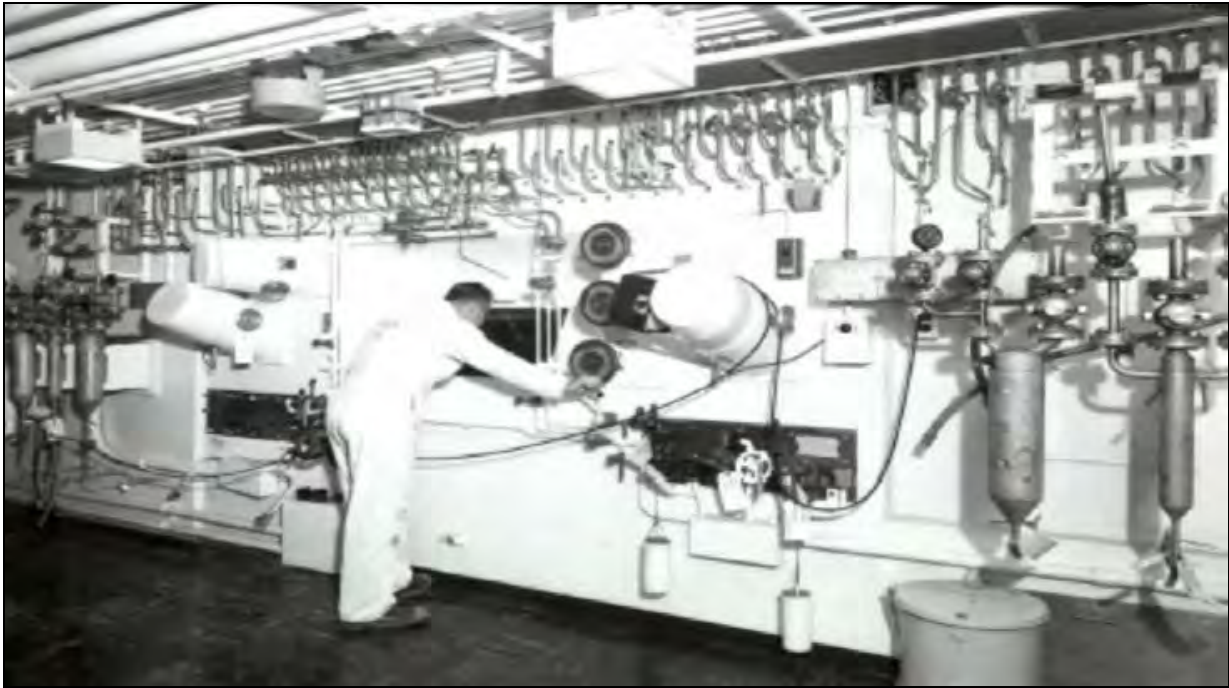

Figure 5-25: Operating Face of L-Cell

- M-Cell was also originally built as a spare in the eastern row of cells. The principal function of M-Cell was to provide temporary storage and sampling capability for concentrated uranium solutions flowing from the first-, second-, and third-cycle solvent extraction operations. Four tanks and a variety of pumps complete these tasks and supply the necessary measurements of accountability for the plant. Due to the potential need for maintenance, the pumps are shielded from the vessels by an internal concrete wall that is 1.5 feet thick by 15.5 feet tall (Stacy, 2006).
- N-Cell housed six critically-safe storage tanks that were used to temporarily store aqueous uranium solutions from first-cycle extraction that were awaiting processing through second and third cycles of the process. One tank was also used to store a specialized neptunium concentrate until enough had accumulated for a unique processing run. Although the tanks were critically safe by geometry, a criticality event in B-Cell in 1959 (also used to store intercycle solutions) made it clear that there was potential for inadvertent damage of concentrated uranium solution to the process equipment waste system and a corresponding vulnerability for criticality. To prevent this, CPP engineers adapted a standard device for criticality control, Raschig Rings. (Raschig Rings are pieces of tube (usually ceramic or metal, equal in length and diameter) used in large numbers as a packed bed within columns for distillations and other chemical engineering processes. They provide a large surface area for interaction between liquid and gas or vapor.) These rings were usually installed in the processing columns. Instead, in this case, they were installed on the floor of the N-Cell, where they could keep concentrations of uranium down to acceptable levels. Although the original glass Raschig Rings proved to be too delicate for direct maintenance, a stainless steel mesh installed over the top of them solved that problem and allowed the cell to operate for many years (Stacy, 2006).

- NOTE: To prevent confusion with the number zero (0), no operating cell within the original floor plant of CPP-601 was designated as O-Cell. Later however, a pump room located to the west-northwest of N-Cell began to carry the name. The pumps installed in O-Cell moved solutions between the first-, second-, and third-cycle extraction equipment (Stacy, 2006).
- P-Cell has always been used for solvent extraction of highly-enriched uranium and often worked in tandem with similar systems installed in Q and R/S Cells. It was well-suited as a home for the tall equipment that purified the uranium at this stage of the process; six columns used for extraction, stripping, and evaporation occupied more than half of the long narrow space. Most of the time, P-Cell equipment was used to process second-cycle solutions using hexone as an organic solvent. For a short time early in its history, it was employed for first-cycle extraction. In 1972, a special solution of concentrated neptunium and plutonium that had been collected from seven years of fuel-reprocessing activities was also processed through the extraction equipment in P-Cell. Then, after thorough decontamination, it was ready to once again handle concentrated uranium (Stacy, 2006).
- Q-Cell was designed to take second-cycle uranium solutions from P-Cell and process them through a third, and usually final, cycle of solvent extraction. Hexone was also used as a solvent in Q-Cell's tall columns that were used for extraction, scrubbing, stripping, and evaporation. Sometimes, however, Q-Cell was used to process solutions directly from first-cycle extraction (Stacy, 2006).
- R-Cell does not exist as a separate entity from S-Cell since there are no physical separations between them. Originally, R/S-Cell contained extraction equipment for a fourth and final cycle of solvent extraction and uranium purification. However, after continuous dissolvers were developed and put into routine use at the plant, uranium product from the third-cycle extraction equipment in Q-Cell rarely failed to meet specifications and R/S-Cell extraction columns soon became obsolete. Once cleared, the R/S-Cell space was used again though, particularly in the monitoring of other plant process streams. In 1979, a tank and a system were installed for measuring the density of concentrated uranium solutions. It was hoped that this density monitoring system would help with criticality problems in the uranium salvage system installed in J-Cell. Then, after the J-Cell uranium salvage system was replaced, the density monitoring tank in S-Cell was modified to be used as a decanter to isolate TBP and prevent it from entering the uranium salvage system installed in C and L-Cells (Stacy, 2006).
- S-Cell contains the bottom half of all of the equipment installed in R-Cell. The two cells are one in the same in terms of physical space. Thus, like R-Cell, S-Cell also went through three different iterations during its processing history. Originally, it held fourth-cycle extraction equipment. In 1979, a density monitoring tank was installed to help with criticality problems in J-Cell and, in 1986, a decanter was installed to remove organic solvent from the uranium process stream (Stacy, 2006).
- T-Cell was used, from the beginning, as a reservoir for cold hexone that was received from K-Cell or added fresh from the Process Makeup floor below. The solvent was stored in T-Cell tanks, ready to be pumped to P- or Q-Cell as needed for uranium extraction operations. Pumps and blowers facilitated this transfer (Stacy, 2006).

- U-Cell lies directly beneath T-Cell in the east cell bank. It is one of the two cells in CPP-601 (U- and Y-Cell) that were devoted to the collection of aqueous waste streams from the remainder of the plant. Originally, U-Cell collected raffinates from first- and second-cycle extraction operations, sampled them to verify that they were critically safe, processed them through evaporators to reduce their volumes, and then sent them off to the Tank Farm for long-term storage. However, the volume reduction achieved through waste calcining would soon make the evaporators unnecessary and they were abandoned in place. Additionally, safety upgrades during the 1980s led to a reconfiguration of U- and Y-Cells to combine all sources of second- and third-cycle wastes into a single stream that could be independently sampled for criticality at two different points (Stacy, 2006).
- V-Cell was held as a spare throughout the history of CPP-601 fuel reprocessing. No processing equipment was ever installed. Instead, it served as an office space for health physics personnel working in CPP-601 (Stacy, 2006).
- W-Cell contained tanks and equipment that captured small amounts of the organic solvent, hexone, that lingered in the raffinate streams from first-, second-, and third-cycle extraction. Eventually, lines were rerouted so that all hexone collection was combined in this cell (Stacy, 2006).
- X-Cell occupies the northeastern corner of CPP-601. Like V-Cell, X-Cell never held equipment for fuel processing. However, for a short time it was used as a laboratory for storage and analysis of highly radioactive samples, for the dilution of samples before transport to other laboratories, and for decontamination of the equipment used in sample preparation. These activities were carried out in six shielded areas constructed from lead-filled steel forms and lead bricks within the cell. A monorail and crane transported samples from one area to another or they were manually carried. From the beginning, this lab was plagued with contamination problems; construction of the Remote Analytical Facility (CPP-627) in 1957 made it obsolete. Pumps and blowers added later changed the focus of the cell to solvent recovery and storage (Stacy, 2006).
- Y-Cell was the second of two cells used to collect liquid raffinates from process streams throughout the entire fuel reprocessing plant. Initially, Y-Cell collected some second-cycle streams and all third-cycle streams, sampled them for criticality, and then sent them through evaporators to reduce their volume prior to long-term storage in the Tank Farm. However, eventually all second- and third-cycle wastes would flow through the equipment in Y-Cell for sampling and then transfer to the Tank Farm. The dissolvers were abandoned after being made obsolete by the waste calcining facility. The solvent recovery system was also removed when the liquid waste collection process was consolidated in W-Cell (Stacy, 2006).
- Z-Cell was the last stop for CPP-601's final product, concentrated liquified uranyl nitrate. For a time, the liquid was stored and packaged for shipment in L-10 bottles at a facility set up within Z-Cell. However, after 1969, the liquid was converted to a solid (uranium trioxide) that was easier to handle and ship. The denitrator used in this process, located in the CPP-602 Laboratory building next door, was developed using local expertise acquired during process development for the CPP's waste calciner (Stacy, 2006).

Table 5-3 provides process descriptions and source documents for the cells in CPP-601, the Main Processing Building.

Table 5-3: CPP-601, Main Processing Building Cells		
Cell	Process Description	Reference
A	EBR feed preparation	Irvine, 1954
B	EBR feed storage	
C	NP-MTR feed make-up	
D	NP-MTR feed make-up	
E	SIW feed preparation	Stacy, 2006
F	First-cycle extraction	
G	MTR feed preparation	
H	MTR first-cycle extraction	Irvine, 1954
J	Hot salvage	
K	Solvent recovery	Stacy, 2006
L	RaLa process cell	
M	Sampling	Irvine, 1954
N	NP-MTR feed storage	
O	Pumping	Stacy, 2006
P	First/second-cycle extraction	Irvine, 1954
Q	Second/third-cycle extraction	
R	Product transfer cell	
S	Third-cycle extraction	Stacy, 2006
T	Solvent pump room	Irvine, 1954
U	First-cycle aqueous raffinate	
V	Equipment decontamination	
W	First-cycle solvent raffinate	
X	Sample dilution	
Y	Second/third-cycle aqueous and solvent raffinate	
Z	Product storage	

Equipment in the cells could be reached and moved with large cranes through hatch openings in the ceilings, but plant workers could only enter through doors installed in the Access Corridor three floors below ground.

Each of the shielded cells housed equipment necessary for performing various steps in the reprocessing cycle. Most of the process equipment within the cells was controlled from an Operating Corridor (PO) that ran the length of the building between the two rows of cells in the first story below ground. A double row of instrument panels arranged back-to-back was installed in the center of this gallery. From here, operators could monitor the workings of the cells below and control the flow of solutions into and out of the processing cells. Diagrams and chemical flowsheets that illustrated all of the main processes conducted in the plant were posted there to guide the operators when necessary.

Service lines for water, steam, and condensate also entered the cells at the Operating Corridor level. Directly beneath the centralized Operating Corridor were the Service and Access Corridors (second and third stories, respectively). Sampling corridors ran along the outside of each cell row along with cell exhaust ventilation ducts and off-gas treatment systems.

The Sampling Corridors in CPP-601 ran along the outside of each bank of processing cells on the same level as the Operating Corridor (ground level). Because the dissolution and extraction processes relied on specific chemical inputs, sampling was an important part of process control for the plant, ensuring that the end product was as pure as possible and preventing formation of troublesome solids or chemical ions that might clog the equipment or otherwise cause a plant shutdown. Sampling was also very important for accurate accounting of the fissionable material present in the plant at any one time. Once drawn, the sample bottles were placed in lead carriers and manually transported to the Remote Analytical Facility, CPP-627, for analysis.

The Service Corridor (PT) that runs the length of CPP-601, directly beneath the Operating Corridor, is the first basement story of the structure. Shielding precautions were taken because nearly all of the pipes that carried "hot" radioactive solutions between processing cells were located here. Ventilation tunnels also ran the length of this level along the outside of the cell rows. Air from the processing cells and Sample Corridor was exhausted through these tunnels and then ultimately delivered to the main stack for discharge. The ventilation system provided twenty air changes per hour to the process cells, primarily to sweep out any potentially-explosive solvent vapors that might have accumulated there. Negative pressure, maintained in all of the processing areas, effectively ensured that radioactive contamination did not spread into the ventilation system. Vapors directly from the processing equipment, which could have contained radioactivity, were collected in special piping systems in the ventilation tunnels and then delivered to CPP-604 for filtration through off-gas systems.

The Access Corridor (PA), located in the third level below ground in CPP-601, contained the doorways that workers used to gain entry to the interiors of all of the processing cells. This corridor also served as a fresh-air intake for the plant. Fresh air was pulled into the processing cells through louvers in the doors. When these doors were opened for entry of decontamination, maintenance, and/or construction workers, the negative pressure maintained within was reduced. Temporary tents were often placed at the entrance to cells that were to be opened to help control airflow and reduce the spread of contamination outside the shielded cell walls. Labyrinth corridors were also constructed at the entrance to each cell and around some of the pumps and other equipment located outside of the cells to prevent any direct shine of radiation out into the Access Corridor.

5.1.2.2 CPP-602 Laboratory

The CPP-602 Laboratory was located north of and adjacent to the Fuel Process Building (CPP-601), with which it shares a common wall and utilities. The interior of the CPP-602 Laboratory was divided into offices, laboratories, and other areas with partitions made of steel, wood and gypsum board, or cinder block.

The exhaust air from occupied areas, hoods, glove boxes, and the hot cell was drawn by blowers through roughing and high-efficiency particulate air (HEPA) filters for venting. All air was exhausted through HEPA filter systems in CPP-602 Room 330, on the roof of the CPP-630, or vented via the

CPP-601 vent tunnel to the Atmospheric Protection System (APS) in CPP-649 via the CPP-601 east vent tunnel. The APS vents to the atmosphere via the Main Stack.

Most of the air in the basement was exhausted via the service corridor of CPP-601 or went to the east vent tunnel via the hot cell, glove boxes, and hoods of Laboratory 103A and the hood of Laboratory 121B. The northeast hood in Laboratory 103A, the hoods and glove boxes in Laboratory 103B, the hood and denitrator product repackaging glove box in Room 109, and the hoods and glove box in Room 325 on the second floor were exhausted through HEPA filters on the roof of CPP-630. All of the air on the first-floor laboratories, Laboratories 315 and 327 on the second floor, and the product handling Room 102 was exhausted through HEPA filter banks in Room 330 to the roof of the CPP-602 Laboratory (Grigg, 2008).

5.1.2.3 CPP-603, Fuel Storage Building

The safety and security concerns that dictated placement of the Fuel Storage Building, CPP-603, one-third mile away from the Main Processing Building and other analytical facilities probably also entered into the decision to install systems that made the building nearly self-contained within the remainder of CPP.

The building was designed to receive fuel elements in a main crane bay via a 15-ton crane. A long transfer canal paralleled the crane bay; branching off from there were two basins where the fuel was stored. The two basins provided storage for about 1,000 buckets that could hold as many as 4,000 separate fuel elements, depending on overall size and criticality considerations. At least 15 feet of water covered all radioactive materials that were handled outside of the lead casks used for transportation.

In 1957 and 1958, CPP-603 was expanded in response to planned shipments of fuel elements from the Savannah River Site. The new "Fuel Element Cutting Facility" added to CPP-603 at that time housed a large crane bay serviced by two cranes, a new storage basin, and a hot cell. Large fuel elements in casks weighing up to 75 tons were received in this facility via truck or rail and then unloaded into the transfer basin where they could be removed. Once the fuel elements were free of their shielded casks, operators used a 3,000-pound transfer crane, complete with a riding car, to place them in cadmium-poisoned storage racks which could then be moved into the new storage basin. Oversized pieces were delivered to the new hot cell where operators used hydraulically-operated saws and other equipment to mechanically alter their shapes and make them suitable for storage and reprocessing at CPP.

In 1974, as CPP began to experiment with, and ultimately begin production-level processing of, graphite-based fuel elements, facilities for dry storage were added to CPP-603. These additions were necessary because the graphite fuel elements reacted violently if exposed to water, and thus could not be stored in any of the existing underwater basins. Called the "Irradiated Fuels Storage Facility," this was the first dry-storage facility designed, built, and actively used in the U.S. Initially, the facility consisted of forty-seven underground vaults, each measuring sixty square feet, lined with stainless steel, and capped with removable heavy concrete covers. In 1975, another building was added to handle more shipments of graphite fuels.

5.1.2.4 CPP-604/605, Waste Disposal Building and Rare Gas Plant

Both liquid and gaseous wastes were processed in the Waste Disposal Building (CPP-604). Here, liquid wastes were evaporated in order to reduce their volume, then sent for storage in the tank farms. However, the gaseous wastes were processed in a portion of the building designated as the off-gas area (CPP-605). Here, isotopes of krypton and xenon were recovered at the CPP from off-gas produced in the aluminum-clad fuel dissolver (Irvine, 1954).

5.1.2.5 CPP-620, Chemical Engineering / High-Bay Laboratory

The High-Bay Laboratory was built in 1968 as a chemical engineering laboratory facility where versatile equipment was located. The facility was used primarily for non-radioactive testing of plant processes and for the development and improvement of new processes. However, some projects were carried out with un-irradiated uranium. The facility was designed to house tall equipment and to allow for embodied experimental equipment to be installed and removed in prefabricated modules.

The major equipment in CPP-620 consisted of the equipment housed in experimental modules and the chemical makeup equipment that was fixed in position. Each module was a structural-steel framework containing the equipment associated with the particular experiment. Vessels, pumps, stirrers, piping, and valving associated with chemical makeup were located in an area between the south office and the south wall of the building. Instrumentation, control panels, and electrical equipment panels associated with the various experimental modules were located on the Mezzanine level. The building also had three offices arranged down the center surrounded by the experimental areas. The exterior tops of the offices constituted a control area at the Mezzanine level which connected with the experimental modules by catwalks.

No fixed radiation instrumentation was installed in the High-Bay Laboratory. A portable Continuous Air Monitor (CAM) was located against the north wall of the west experimental area to provide radiation monitoring coverage during those infrequent times when radioactive materials were used. This monitor was equipped with a strip chart and meter to give both a visual and a permanent record of air activity. A bell alarmed to warn personnel when air activity reached a preset limit (CPP Safety Review, 1974).

5.1.2.6 CPP-627, Remote Analytical Facility

The Remote Analytical Facility (RAF), CPP-627, was home to a variety of customized dissolution processes, but it also filled an important analytical role for the plant. The building was constructed in 1955 to house analytical, experimental, and decontamination facilities. The analytical portion of the building, located on the ground floor within the northern third of the building, consisted of thirty-two shielded glove boxes, each measuring about one meter square, and arranged in a row much like the operating corridor in CPP-601 (see Figure 5-26). Viewing windows and manipulators in these boxes allowed for remote sample preparation and analysis.

The northern third of the building housed radiochemical analytical facilities. The RAF, consisting of two lines of shielded cells for remote sample preparation and analysis, was on the ground floor. The Old Shift Laboratory (OSL, Room 201) on the second floor provided bench and hood space for chemical analysis of nuclear reactor fuel samples of low-to-moderate activity. The OSL operated in

conjunction with the RAF to supply 24-hour analytical services in support of CPP-601 and calciner operations. Analytical services were provided round-the-clock to plant operations (INEEL, 2004). The middle third of the building was a high bay decontamination laboratory, providing space for water and chemical cleaning of contaminated equipment from all over the NRTS.



Figure 5-26: Shielded Glove Boxes in the Remote Analytical Facility

Like most of the facilities at CPP, CPP-627 was in constant evolution. In 1956, only six short months after the first hot samples were introduced for analysis, modifications were made in response to feedback from the scientists who had been using the new equipment. As a result of these analysts' concerns, remote mechanical arms and manipulators replaced the more clumsy remote switches and gears originally installed in the glove boxes.

The southern third of CPP-627 contained two experimental facilities, the Hot Chemistry Lab (HCL, Room 104) and Multi-Curie Cell (MCC, Rooms 104 and 106). Both were used for small-scale custom dissolution processes and other hot analytical work (INL, 2006). A large walk-in hood installed in the HCL was home to some of CPP's custom dissolution equipment and the remainder was installed in the MCC. This cell was shielded to the same degree as the main processing cells in CPP-601, enabling researchers to mock up near-production-level processes in their experiments. In 1972, a solution containing 5,412 grams of neptunium and 544 grams of plutonium was pumped from the CPP-601 processing equipment to a temporary packaging facility in the CPP-627 Multi-Curie Cell. There it was bottled, packaged, and shipped in specialized containers to the Savannah River Site for further purification and ultimate conversion to Pu-238.

All work in the MCC was conducted remotely with master-slave manipulators for light work, and a 2,000-pound hoist for removing cask lids and other heavy work. A 15-ton cask dolly delivered the casks of fuel to the cell through a massive, 18 in.-thick, lead-filled door that weighed 20 tons.

5.1.2.7 CPP-630, Mass Spectrometry Facility

CPP-630 was located adjacent to the east side of CPP-602, with which it shared a common wall. The internal laboratory walls were of steel construction and the floor was a base of poured concrete on earth, with no buried utilities. The Mass Spectrometry Facility was part of the Radioanalytical Chemistry Department, and the majority of the samples processed in this lab were final-product samples containing mostly uranium (CPP Progress Report, Sep1955). Laboratory air from the various laboratories, hoods, and glove boxes was exhausted through HEPA filters and blowers located on the roof of CPP-630.

5.1.2.8 CPP-631, RaLa Off-Gas Filter Building

The RaLa off-gas system was designed and installed to capture the gases generated during the operation of the RaLa process system in L-cell of CPP-601. The RaLa process posed two problems: (1) the activity hazard due to the liberation of radioiodine and radioxenon; and (2) the build-up of explosive hydrogen gas. The radioactivity of the liberated gases was too high to allow for venting to the atmosphere, and the concentration of hydrogen made mechanical compression and storage of the gases dangerous.

Originally, a caustic scrubber was installed in L-cell for processing these gases. However, there was no means of storing the gases for decay in the volume and composition encountered. A 10,000-cubic-foot tank was installed in July 1957 to hold the gases that made it through the scrubber. It was quickly noted, however, that radioiodine could escape from the system without passing through the scrubber. The solution to the problem was the installation of a separate RaLa off-gas handling system with the storage tank, blowers and jets for venting, and carbon beds for iodine removal (Smith, 1981).

The RaLa Off-Gas Filter Building, also known as the RaLa Off-Gas Cell, was an underground concrete structure constructed in the earthen berms outside the southeast corner of CPP-601. The building contained a centrifugal blower, carbon beds enclosed by lead shielding walls, filters, a hydrogen analyzer, and all of the utility connections, ventilation, heating, and instrumentation necessary for equipment operation. Piping between CPP-601 and CPP-631 ran through an underground concrete tunnel. This tunnel also served as a ventilation duct into the vent corridor of CPP-601, providing a slight negative pressure inside the Off-Gas Building (Moser, 1985).

5.1.2.9 CPP-633, Waste Calcining Facility

Construction on the Waste Calcining Facility (WCF) began in 1958 and was completed in 1961. The WCF building was built east of CPP-601 and south of the tank farm. The building contained everything required for the calcining process except for the tanks that stored fuel oil and the bins that would store the calcined product.

The sub-grade processing cells were arranged in two parallel banks with a shielded corridor between them. This corridor had operation control panels, monitors, and switches. The calciner vessel had

elaborate piping systems that fed it with heat, liquid waste, and hot fluidizing air, and carried away its byproducts. Off-gases went to the CPP stack; the calcine went to storage bins (INEEL, 1998).

The main floor level was built four feet above grade and contained five rooms. A Health and Safety Office included a small shielded cubicle for sampling the gases that were leaving the building. A Switch Gear Room contained the electrical power controls for the facility. A Locker Room for personnel contained bathrooms and hand and foot counters. The Decontamination Room contained tanks filled with the chemicals that made up the solutions added to the waste feed, or that flushed the operating cells after a campaign. A hopper containing the calciner start-up material also was located here, along with compressed air equipment, steam manifolds, and solution-transfer pumps. The fifth room was the Heating and Ventilating Room. Outside air entered the supply unit, was filtered, heated, washed, and reheated before it was sent to the rest of the main floor or to the operating areas below.

A special equipment room for handling NaK (sodium-potassium alloy) was located three and a half feet below the main floor and just above grade level. The location of this room prevented leakage into the other rooms or cells of the building because it was actually a separate building connected to the main level by a hallway, but sealed by two doors. The room contained the NaK furnace, tanks, fluidizing air blowers, pumps, indicators, and a helium manifold system. To accommodate the furnace, its ceiling was 30 feet high.

A Filter Removal Room was approximately at grade level, also. Off-gases from the calciner were passed through filters to remove fine radioactive and other particles. The filters were in three cells just below the Filter Removal Room and, when spent, had to be replaced with fresh filter units. Operators worked outside this room and managed the filter-replacement procedure remotely. They stood in the filter-removal corridor behind a shielded glass viewing window (40 inches thick) to operate the crane and other equipment. A 20-ton bridge crane lifted the four-foot thick concrete cell covers, helped place the spent filters in special shielded transport casks, and then placed the casks for pick-up by "straddle carriers." The carriers took them to a waste storage facility elsewhere at NRTS.

The operating corridor rested below grade and could be accessed via a stairway from the main floor. The main instrument panel was centered in this corridor, while service piping for the cells ran along the sides. Also located at this level was the Sample Room, from which operators could collect a sample of either the liquid waste or the calcine for transport to a hot cell or laboratory for analysis.

The access corridor provided access to the process cells and related equipment located directly below the operating corridor. On each side were the hot process cells. Technicians could access the calciner and other cells by going through a labyrinth of concrete shields. A Waste Hold Tank Cell was at the east end of the corridor. The tanks held the liquid waste solutions awaiting feed into the calciner. The solutions (including spent decontamination chemicals) rested here until the next campaign, when they became part of the feed into the calciner.

Next to this was the large Calciner Cell, which contained the calciner vessel itself, the NaK heat exchanger, the calciner cyclone, feed-metering pot, and other related equipment. Maintenance technicians entered this cell through a shielding labyrinth. Next to the Calciner Cell, the off-gas cell contained quenching tanks, pumps, venturi scrubbers, and other equipment related to the handling of the gases liberated by the calciner. Other cells included a hot sump tank cell (situated beneath the

access corridor floor), adsorber manifold cell, two adsorber cells for ruthenium-106, and a filter piping tunnel (INEEL, 1998).

For maintenance during shutdown periods, crews used remotely-controlled cleansing sprays to flush each operating cell. Equipment pertinent to the operation of each cell was located just outside the cell, typically encased in shielded lead or steel cubicles. Crews used ladders, platforms, and removable hatches to gain access to the equipment. Most equipment was made of stainless steel to resist the corrosive attacks of decontaminating solutions and the acids of the radioactive feed itself.

5.1.2.10 CPP-637, Process Improvement Facility / Low-Bay Laboratory

Process support and pilot plant studies were carried out in the labs of the Process Improvement Facility (PIF). Also known as the Low-Bay Laboratory, the PIF was a chemical engineering laboratory facility built in 1959 with functions very similar to those performed in CPP-620. Equipment was located in this facility primarily for non-radioactive testing of plant processes and for the development of new processes. As with the High-Bay Lab, some projects were carried out with un-irradiated uranium.

The north and south halves of the Low-Bay Laboratory were administratively divided into ten experimental spaces, each 8-ft. wide. In these spaces were placed experiment modules consisting of a structural-steel framework that housed the experimental equipment (CPP Safety Review, 1974).

5.1.2.11 CPP-640, Hot Pilot Plant/Headend Process Plant

CPP-640, originally known as the Hot Pilot Plant, was initially designed to test new equipment and chemical flowsheets in support of the fuel-processing operations in CPP-601. Built in 1961, the building was constructed as an empty shell with five shielded test cells, waste collection tanks in two vaults at the lowest level of the building, and an open crane loft with space for chemical makeup equipment and removal of cell roof hatches. A major modification in the late 1970s added the shielded Mechanical Handling Cave in the process makeup area of the structure for processing graphite fuels.

The facility was designed to allow for maximum flexibility of future test assemblies. Cells 3, 4, and 5 were equipped with two removable shielding walls to allow for possible large tests. Numerous pipe slots through the cell walls (shielded with lead bricks when not in use) and cast-in-place pipe penetrations provided access for instrumentation, control piping, and wiring. A heavy-duty cart capable of transporting heavy shielded fuel casks served Cells 1 and 2. Fuel charging ports were available at the top of the other three cells. Until early in the 1970s, a variety of experiments were conducted in the facilities of CPP-640; two of these processes, involving electrolytic dissolution of stainless steel-clad fuels and combustion of those clad in graphite, were particularly successful and soon took over (known as the "headend" process). After 1973, the structure began to be known as the Headend Processing Plant, dedicated first to electrolytic dissolution, and then sharing space with the graphite combustion process. Eventually (after the time period under evaluation in this report), Cell 5 of CPP-640 would be devoted exclusively to the electrolytic dissolution process.

5.1.2.12 CPP-709, Eastside Service Waste (ESSW) Monitoring Station

The ESSW Monitoring Station was constructed (1951-52) about 75 feet east of CPP-601 to house the ESSW monitoring equipment. Waste water from floor drains, steam condensate lines, equipment cooling jackets, and the process equipment waste evaporator was routed through the basin of this building and pumped to an injection well (CPP Plan, 1997).

5.1.2.13 CPP-734, Westside Service Waste (WSSW) Monitoring Station

The WSSW Monitoring Station was constructed (1950-60) about 150 feet southwest of CPP-601 to house the WSSW monitoring equipment. The normally-uncontaminated wastewater from steam condensate and equipment-cooling lines was routed to the basin of this building for monitoring and then flowed by gravity to an injection well. Upon detection of radiological contamination in the waste flow through CPP-734, an alarm signaled CPP plant operators to immediately stop or divert the contaminated waste water flow (CPP Plan, 1997).

5.1.2.14 High Level Liquid Waste Tank Farm

The HLLW Tank Farm has been in service (receiving liquid waste until it can be solidified) since 1954. The Tank Farm consists of eleven 1,135,624-liter (300,000-gallon) tanks, four 113,562-liter (30,000-gallon) tanks, four 68,137-liter (18,000-gallon) tanks, and associated equipment for waste transfer, monitoring, and control. One of the 1,135,624-liter tanks is designated as a spare and is always maintained empty in the event of an emergency. The 1,135,624-liter tanks are constructed of stainless steel and housed in underground concrete vaults. The concrete vaults sit on bedrock about 13.7 m (45 ft) below grade with the top of the vaults about 3.0 m (10 ft) below grade. This distance includes approximately 15.5 cm (0.6 ft) of soil over a synthetic membrane. The 113,562-liter tanks are constructed of stainless steel, set on concrete pads, and covered with about 3.0 m (10 ft) of soil. The 68,220-liter tanks are also constructed of stainless steel and are housed inside stainless-steel-lined concrete vaults located in the bottom of the Waste Treatment Building, CPP-604.

The majority of liquid waste stored in the Tank Farm was generated during the first-, second-, and third-cycle extraction processes. These wastes include high-level wastes that are composed of first- and second-cycle raffinates and intermediate-level wastes that are composed of third-cycle raffinates blended with concentrated bottoms from the Process Equipment Waste (PEW) Evaporator. Additional wastes stored in the Tank Farm include fluoride- and cadmium-bearing wastes from the fluorinel process, decontamination wastes containing fluoride from waste calcining, process salvage streams from J-Cell after extraction, and occasional transfers from WL-104 and WL-105, which are part of west side service waste disposal system.

Liquid wastes are transferred to the Tank Farm from various CPP plant areas through underground stainless steel lines. These buried lines and associated equipment constitute both a system for the transfer of high-level, liquid radioactive waste and one for the transfer of less-radioactive intermediate-level, liquid waste. All the transfer lines are piped and valved separately throughout the Tank Farm area so the integrity of the various waste types is maintained.

Most of the nonradioactive, liquid discharge originates from the CPP utilities areas in CPP-606, CPP-644, and the coal fired steam-generating facility. Cooling water for the secondary heat transfer system for the CPP liquid waste Tank Farm is routed directly to service waste without monitoring for radioactivity because the primary systems are monitored. Potentially radioactive, liquid effluents at the CPP are associated with heating- or cooling-water streams from various processes throughout the plant.

5.1.2.15 Calcined Solids Storage Facilities (CSSF)

Initially, the radioactive liquid waste from the HLLW Tank Farm was sent as feed to the Waste Calcining Facility and after the WCF was shut down, to the New Waste Calcining Facility (NWCF). The product of the calcining facilities takes the form of fission-product salts that are then transported by air to the CSSFs for storage.

There are seven CSSFs. CSSFs 1–6 provide containment for the radioactive calcined solids. The CSSFs are separate (separated by distance), self-contained facilities and there are no interconnections between them, except for the storage bin vent off-gas systems. CSSF 7 was completed, but never placed into service since CSSF 6 was never filled to capacity. CSSFs 1–6 were sequentially built between 1959 and 1984 and placed in service as they were completed. The storage bins of CSSFs 1–5 are effectively filled to their usable operating capacity. The CSSF 6 storage bins are filled to approximately 50% of capacity. CSSFs 1–3 store calcine produced by the WCF. CSSFs 4 and 5 are filled with calcined material produced by the NWCF.

5.1.2.16 Auxiliary CPP Facilities (Non-Radiological)

To support operations, there were several non-radiological support buildings in the CPP complex. North of the Laboratory building was the Service Building (CPP-606), which supplied the heat, water, air, and emergency power to both CPP-601 and CPP-602. To maintain security, the Main Guard House (CPP-609) was erected at the perimeter fence directly west of the Laboratory building. North of the Spent Fuel Storage building stands the North Guard House (CPP-610). Completing the list of buildings in this area are a number of buildings for storage of non-radioactive parts and materials (CPP-607, -608, -615, -616, -617, and -710), electrical transformer buildings (CPP-704, -705, -706, -707, and -718), pump houses (CPP-611 servicing Well Number 1, and CPP-612 servicing Well Number 2). Also present at various times were several temporary structures of frame construction with tar paper coverings for service use (CPP-618, -622, -623, -624, -625, and -626).

5.1.2.17 Overview: Fuel Reprocessing Operations

The CPP fuel-reprocessing operation basically followed five main steps:

1. The first step involved the transfer of actual spent fuel elements to the plant. These highly-radioactive elements were brought to the CPP in lead shipping casks transported via truck or railcar. They were received by a large crane in the fuel storage building, CPP-603, where they were stored for days, months, or even years until enough fuel of a particular type had accumulated to make a processing run economical. No fresh fuel was accepted at CPP-603; all had a minimum of ninety days cooling. Prior to arriving at the CPP, even ninety-day-old fuel had to be stored in

CPP-603 for at least thirty additional days in order to meet the minimum 120-days cooling time before being submitted for reprocessing.

2. Once the fuel assemblies stored in CPP-603 had cooled sufficiently, and a large-enough quantity of a specific fuel type had accumulated, specific amounts could be placed into a shielded cask and loaded onto a specialized Gerlinger straddle truck for transfer to the fuel processing area of the plant. Typically this transfer involved a trip of approximately one-third of a mile down Maple Street from the Fuel Storage Building, CPP-603, to the Main Processing Building, CPP-601. Fuels clad in graphite and stainless steel, and processed after 1961, were also transported down Maple Street, but their final destination was the Hot Pilot Plant/Headend Process Plant, CPP-640, constructed adjacent to the main processing building. After 1986, some fuels alloyed with zirconium were stored and initially processed in a new facility, the Fluorinel Dissolution Facility (CPP-666). Chargers, the specialized transfer casks used at CPP, were capable of discharging fuel directly to a dissolver, to a shielded chute leading into a dissolver, or to a remote cave or cell, from which the dissolver could be loaded remotely with manipulators.
3. Once in the dissolver vessel, the fuel was combined with various acid-based chemical reagents that would ultimately transform it into liquid. This aqueous mixture was transferred by steam-jet suction to a series of other vessels for separation of the fuel constituents.
4. Separation took at least two cycles, during which the uranium was extracted from the acids, structural alloys, and fission products, through the use of organic solvents.
5. The uranium solution (uranyl nitrate) was separated from the solvents, which were often purified and recycled for new processing runs.

As in any processing plant, sample analyses form the basis for control of the CPP process; thus, samples were taken of each of the process streams at varying intervals (CPP Contract, 1955). The radioactivity of the various sampled solutions complicated the sampling procedure. All process solutions samples had to be removed from the process without exposing personnel. Fission products in the sample solution made contamination of the sampling equipment and sampling area a problem during plant operation. Designers of the remote sampler and the sample transfer shield considered these problems and tried to minimize them as much as possible.

The remote sampler draws the sample from the process stream inside of the cell and discharges it into a small glass bottle. A sample line and a sample return line penetrate the cell wall connecting the sampler with the vessel to be sampled. In some places, a small vessel called a sample pot is used specifically for sampling. In many other cases, the sample is taken directly from the vessel. An air jet provides the force required to move the sample stream through the sampling lines.

The sample and jet are located inside a four-inch-thick lead and steel shield that runs the length of the sampling corridor. A four-inch-thick lead glass window penetrates the shield at each sample station so that the operator can observe the sampling operation. Architecturally, a bulge in the sampling corridor dedicated to sampling was called a "sample blister." Each sample blister was equipped with a remote handling device, a light, and a shielded area ("sample pig garage") where the sample could be transferred into a transport shield ("sample pig") (Stroschein, 1967). A sample blister might

contain multiple sample stations for redundancy in the case of equipment problems and/or contamination issues.

Denitration Process

For many years, the highly-concentrated uranium solution was bottled and then shipped as liquid uranyl nitrate solution to Oak Ridge to be further refined and manufactured into reactor fuel. To maintain a safe geometry, the stainless steel product bottles were contained in bird-cage-type containers.

Because CPP liquid-shipping containers did not meet all requirements of the safety regulations for off-site shipments, as set forth in AEC Manual Chapter 0529, alternative methods of packaging and shipping were investigated. Results of the study indicated that conversion of the liquid product to a solid UO_3 product by fluidized bed denitration, and shipment of the UO_3 in standard Y-12 Model-FD shipping containers would satisfy the requirements of the AEC Manual.

All product shipped after 1969 was converted to solid oxide using the following process before leaving CPP:

The uranyl nitrate solution contained in one bank of storage cylinders in Z cell - about 140 liters at approximately 350 grams uranium per liter - was processed as a batch. The solution was piped at a rate of about 10 L/h to the process room, where an air-atomizing nozzle sprayed the solution into the heated fluidized bed. The product denitration process was located in a room built next to the original product room in part of an area that in previous years was occupied by a storeroom. The processing room was 13 by 18 by 14 feet tall, and had an operating pit, 8 by 6 by 3 feet deep to supply the necessary headroom. The room housed all of the necessary control panels and most of the major pieces of equipment for the process. The feed line came from Z-cell storage tanks, and the off-gas line returned to Z-cell VOG piping after being filtered. The filtering section of the denitrator vessel contained three sintered metal filters for removal of oxide dust from the off gases. Each filter had a double-filtering wall in a concentric cylindrical shape, and a mean pore diameter of 15 microns. The sole purpose of the operating pit was to provide operating room below a glove box used in product packaging.

Sampling and packaging of the granular product was performed in a glove box where each 60-kilogram batch of oxide produced from denitrating a batch of feed from one Z-cell bank is divided among five or six plastic bags. Only one bag of product was normally in the glove box at a time. The glove box used for packaging product and taking samples was constructed of stainless steel sheet and Plexiglas, and was approximately 26 inches high, 48 inches wide, and 28 inches deep. It contained three glove ports, a sphincter, a bag-out port, a door, and a twin-shell blender. It was connected to the hood-exhaust system and kept under a slight vacuum. The glove box off-gas line had a high-efficiency filter to keep any oxide dust from entering the hood exhaust system (Bjorklund, 1970).

Waste Storage

Every kilogram of purified uranium produced at the CPP created on average over one hundred gallons of acidic liquid radioactive waste that had to be safely stored. These raffinates were maintained in an acidic solution and stored in a series of stainless steel tanks constructed at the Tank Farm. Initially, only two 300,000 gallon tanks were located there, but eventually, nine more of these large vessels were constructed along with the four smaller 30,000 gallon tanks. The large tanks stood 21 feet tall at the eaves, 50 feet in diameter, were made of stainless steel, and were enclosed in concrete-lined vaults. More than half of them were equipped with cooling coils necessary to safely store intensely radioactive solutions.

5.1.2.18 Overview: Isotope Recovery

While the radioactive isotopes that contaminate spent reactor fuel tend to be a radiological nuisance, they can be a source of valuable radioactive by-products. At CPP, several were isolated during the fuel-reprocessing operation and shipped to other laboratories for use in research and weapons production.

RaLa Process

Lanthanum-140 is produced when barium-140 undergoes radioactive decay. Recovery of La-140 was a complicated process completed in a specialized processing cell, L-Cell, in CPP-601. Beginning in July 1954, a shielded viewing window, remote-handling manipulators, a periscope, and intercom system were installed in the vacant L-Cell that would allow an operator to see and hear the work going on behind six feet of concrete shielding. A wide variety of equipment also began to appear inside the cell. Equipment added to the cell included an elevator, two large centrifuges, a dissolver and its charging chute, an off-gas scrubber, and process tanks of many sizes (Stacy, 2006).

Construction was essentially complete by November 1, 1955, allowing Phillips Petroleum Company to initiate start-up of the extraction program. Calibration of instruments and equipment continued until April 1956. Tests using un-irradiated material were conducted between April 25 and November 23, 1956. Test batches of irradiated material were processed between November 24, 1956 and June 30, 1957, at which time the process development was considered complete (Legler, 1957)

The complexity of this project was due in large part to the extremely high amount of radioactivity present in the fuel elements. The short-lived barium isotopes were present in irradiated fuel removed from the Materials Test Reactor (MTR), but they decayed rapidly after being removed from the reactor core. After about forty days, these isotopes were gone. To isolate these short-lived products, fuel elements were processed immediately after being removed from the MTR.

These intensely-radioactive fuel elements were placed in a hot sodium hydroxide solution that dissolved the aluminum cladding, leaving the barium and other fission products as solids. This combination, or slurry of solids and liquids (somewhat akin to a mixture of mud and water) was sent to one of two centrifuges where the whirling motion drove the barium with other solids to the wall of the bowl and the clear liquid, with its dissolved metal, to the center where it could be skimmed off. Successive dissolution with other reagents, centrifuging and skimming left barium nitrate only on the wall of the centrifuge bowl. It was then dissolved in water so that it could be moved to a product cup

by skimming. Here it was evaporated to dryness. The cup was placed in a shielded shipping container with lead thick enough to shield against the tens of thousands of curies of radioactive material from the tiny source (a gram or so). This product was shipped to other AEC labs for specialized uses requiring high radioactivity and rapid decay. The RaLa process campaign ran from 1957 to 1963, during which over a million curies of Ba-140 were recovered.

Neptunium and Plutonium

For most of CPP's processing history, the small amounts of neptunium and plutonium present in plant dissolver products were sent, with other fission products as waste, to the Tank Farm. From 1965 to 1972, the first-cycle extraction raffinate streams that contained these isotopes were resubmitted to the first-cycle extraction equipment along with chromic and nitric acids, which reoxidized the neptunium so that extraction could eventually take place. For seven years, these neptunium/plutonium-bearing solutions were stored in tanks in CPP-601 (N-Cell), awaiting a final processing run. In 1972, an increased demand for neptunium, combined with an immediate need for more storage space in N-Cell, drove a three-week campaign to separate the neptunium and plutonium from the remaining fission products through a further extraction cycle. The product solution that resulted, containing 5,412 grams of neptunium and 544 grams of plutonium, was pumped from the CPP-601 processing equipment to a temporary packaging facility in the CPP-627 Multi-Curie Cell. There it was bottled, packaged, and shipped in specialized containers to the Savannah River Site for further purification and ultimate conversion to Pu-238.

Rare Gases

Krypton and xenon are both produced in significant quantities during uranium fission in a nuclear reactor. Because of their inert, gaseous nature, both are of possible value to scientific research. To recover and purify these gases, a Rare Gas Plant was installed at CPP in 1958. The plant was designed to recover several thousand curies per day of krypton, and a significant volume of xenon, from off-gas evolving from the acid dissolution of spent fuel elements. The original process used charcoal absorbers (operating at liquid nitrogen temperatures) for removing radioactive krypton from the dissolver off-gas. When the absorbent was saturated, it was heated to drive off the rare gases which were then collected in a cold trap. However, the product from this early process was impure, and the cooling requirements of the process required more nitrogen than the existing liquid nitrogen plant could produce on a continuous basis. After it became desirable to operate the fuel dissolvers on a continuous basis, a cryogenic distillation process was installed to reduce the liquid nitrogen requirements and to produce pure products (Offutt, 1969).

5.1.2.19 Overview: Waste Calcination

The WCF began operations on May 18, 1961 with two years of "cold" operations using simulated waste. Cold start-up consisted of 10 runs: the first run used water as feed to check out equipment and operational problems; the other runs used simulated $\text{Al}(\text{NO}_3)_3$ -nitric acid waste to check out equipment, operational, and calcination flowsheet problems (Newby, 2000). Such runs illuminated numerous deficiencies in the equipment or the process, all of which were overcome or accounted for in various modifications and adjustments. In addition, the cold runs provided analysts an opportunity to determine what safety precautions were needed to operate the facility. The two years of

experimental runs prepared the plant for its first hot run, which began on December 23, 1963 (INEEL, 1998).

Originally conceived by scientists at Argonne National Laboratory, fluidized-bed calcination was developed to convert radioactive waste solutions to solids (INEEL, 1998). In the calcination process, liquid radioactive wastes are evaporated and the dissolved metals and fission products are converted to salts and oxides. The key step in the calcination process is evaporation and solidification of the liquid radioactive wastes in a heated bed of fluidized particles. Feed is atomized by air and sprayed into a heated bed of spherical particles. Dissolved metals and fission products oxidize to solids as they coat the surfaces of bed particles. Combustion and solid products build up in layers on the bed particles while the gaseous products are swept from the vessel with the fluidizing gases. Most solids remaining in the gas after leaving the primary cyclone are removed in the gas-scrubbing system.

Before being released to the atmosphere, this stream is decontaminated in a series of devices including a cyclone, spray quench tower, scrubber, associated separators, and silica gel absorbers. After filtering, the decontaminated off-gas is transferred to the 76.2-m (250-ft) high CPP stack. The spray quench tower removes particulates from the off-gas; additional particulate is removed through the nitric-acid scrubbing system. Liquid drops from the scrubber are removed to the de-entrainment separator and mist eliminator and then drained to the scrub tank and recycled as calciner feed by transferring it to the waste holding tanks.

Conversion of HLLW to a solid reduces the volume of waste by a ratio of about 7-to-1 and provides a less-corrosive waste form. The calcined solids are in the form of particles 0.2 to 0.6 mm in diameter and made up of aluminum and zirconium oxides. Other metallic oxides and fission product oxides are withdrawn continuously from the bottom of the calciner and are air-conveyed (pneumatically) to underground storage bins. The calciner product removed from the bed and the fines removed from the off-gas in the cyclone are combined and pneumatically-transferred to the Calcined Solids Storage Facilities (CSSF).

Nine calcination campaigns were completed at the WCF, beginning in December 1963 and ending in 1981 when the WCF was replaced by the NWCF. After each campaign, the crews set about decontaminating the cells so that equipment could be inspected and serviced. Automated sprays and steam jets flushed out the cells first, then the technicians - suited-up and masked - raised the hatches and descended into the cells to finish the job, replace worn parts, and make repairs. As the facility aged, post-campaign reports grew less and less enthusiastic about how easy or safe the hands-on maintenance was getting to be. Ruthenium, for example, began to plate out on the interior of the off-gas process vessels. It resisted the internal sprays and exposed workers to hazard as they tried to remove it manually.

Up until 1973, the same crew operated the Fuel Processing Complex and the WCF. Each facility alternated being "on" and "off," which gave adequate time for proper maintenance of the standby facility. By 1973, demand was so great that the two facilities had to operate simultaneously. Design studies also began that year for a new, bigger waste calcining facility.

5.1.3 Test Area North (TAN)

ATTRIBUTION: Section 5.1.3 was completed by Brian Gleckler, Dade Moeller, Inc. All conclusions drawn from the data regarding Test Area North were peer-reviewed by the individuals listed on the cover page. The rationale for all conclusions in subsequent sections of this document devoted to Test Area North are explained in the associated text.

As indicated earlier in Figure 5-2, Test Area North is located in a remote northern portion of the INL Site (approximately 30 miles northeast of the CFA). In 1951, General Electric (GE) was awarded United States Air Force and Atomic Energy Commission contracts to perform the direct cycle work for the Aircraft Nuclear Propulsion (ANP) Program (Stacy, 1995; Thornton, Feb1962). Ground was broken to construct TAN in February 1953, and by Christmas 1955 serious operations were underway at TAN (Stacy, 1995). The TAN facilities were collectively referred to as the Idaho Test Station under the GE contracts. On March 28, 1961, the ANP Program was terminated (Thornton, Feb1962). The ANP Program activities at the TAN were replaced by Safety Test Engineering Program (STEP). STEP received AEC approval on December 28, 1961. On February 6, 1962, the program was assigned to the prime contractor for the INL Site, Philips Petroleum Company. The overall objectives of STEP were: to conduct full scale tests on reactor systems to determine what actually happens to fission products released during a reactor accident; to demonstrate reactor safety; to develop realistic analytical methods useful for future reactor designs; and to use basic information already developed in the Nuclear Safety Program (INL, 1963).

The major facilities at TAN included:

- Technical Support Facilities (TSF)
- Initial Engine Test (IET) Facility (renamed the Initial Engineering Test Facility during the STEP era)
- Flight Engine Test (FET) Facility (renamed the Loss-Of-Fluid Test (LOFT) Facility during the STEP era)
- Low Power Test Facility (LPTF) Area

The physical locations of each of these facilities are depicted in Figure 5-27. The TAN contained approximately 57 buildings during the period for the SEC petition (INL, 2009). Table 5-4 lists the notable radiological structures at the TAN.

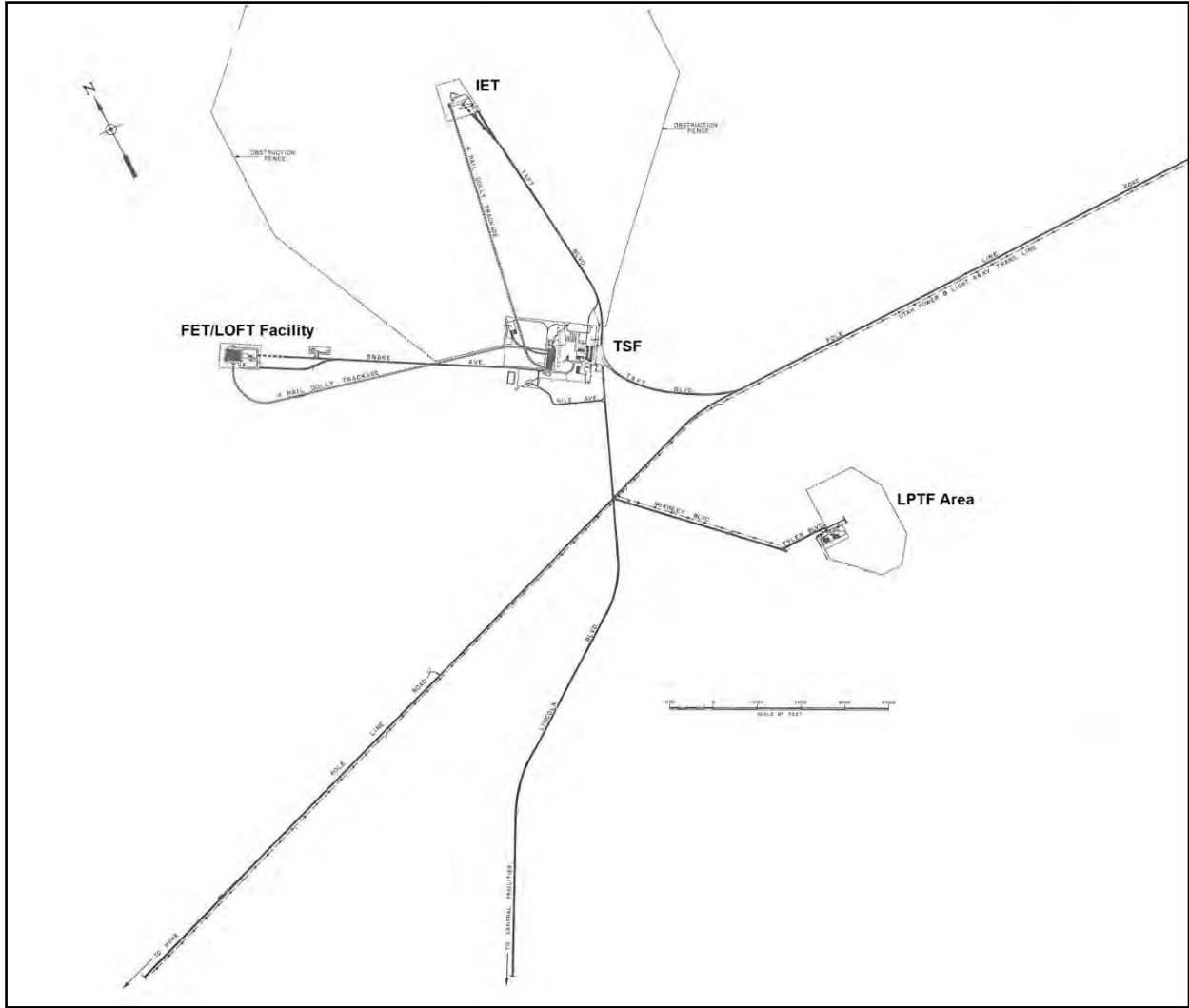

Figure 5-27: Map of Test Area North (TAN)

Table 5-4: Notable Radiological Structures at the TAN				
Facility Name	Building No.	First Used	Last Used	Facility Type
TSF Area				
A&M Building	TAN-607	1955	beyond EP	Assembly, maintenance, and laboratory facility
Hot Cell Annex (HCA)	TAN-633	1955	beyond EP	Hot cells and laboratory
Hot Liquid Waste Treatment Plant	TAN-616	1955	beyond EP	Waste treatment facility
Actuator Building and later TAN Fuel Handling Facility	TAN-615	1956	beyond EP	Actuator testing facility and later a reactor fuel handling facility
Dolly Storage Building	TAN-647	1960	beyond EP	Radioactive materials storage facility
Parts Storage Building	TAN-648	1960	beyond EP	Radioactive materials storage facility
Health Physics Building	TAN-606	ND	beyond EP	Laboratory and radioactive source storage
AEC Health Physics Building	TAN-671	ND	ND	Laboratory and radioactive source storage
TSF Gatehouse	TAN-601	1956	beyond EP	Dosimeter exchange location
IET Facility				
Control and Equipment Building	TAN-620	1955	1966	Reactor control building
Test Cell Building	TAN-624	1955	ND	Movable weather protection building for experiments
Coupling Station ^b	NA	1955	ND	Coupling station for exhaust from nuclear powered jet engines
Change Room	TAN-656	1960	ND	Room for donning and doffing protective clothing
IET Guardhouse	TAN-621	1955	beyond EP	Dosimeter exchange location
IET Exhaust Stack	TAN-712	1955	ND	150 ft exhaust stack for reactor experiments
FET/LOFT Facility				
Test Building (a.k.a. Hangar Building)	TAN-629	1959	beyond EP	Storage facility
LOFT Reactor	TAN-650	beyond EP	ND	Reactor
Control & Equipment Building	TAN-630	beyond EP	ND	Reactor control building
LPTF Area				
LPTF Control & Equipment Building	TAN-641	1958	early 1970s	Reactor control building
LPTF Assembly & Test Building	TAN-640	1958	early 1970s	Reactor test facility
STPF Control & Equipment Building and later EBOR Facility	TAN-645	1960	1966	Reactor control building
STPF Pool Facility Building and later EBOR Facility	TAN-646	1961	1966	Reactor test facility

ND = Date of use not determined

NA = Not available

beyond EP = beyond evaluation period

5.1.3.1 Technical Support Facilities (TSF)

The TSF was originally built to provide technical and administrative support for the ANP Program. The TSF was later adapted to support other programs and projects, such as STEP. The TSF consisted of two areas: the eastern portion was the Assembly and Maintenance (A&M) Area; the western portion was the Administrative Area (INEEL, 2005). The TSF was comprised of a wide variety of structures that were used for radiological and non-radiological purposes, such as: warehouses, administrative buildings, guardhouses, change houses, buildings for utilities, waste handling and disposal facilities, maintenance shops, assembly areas, hot cells, steam plant, jet engine test building, and a large reactor assembly and maintenance building (AEC, 1954-1986; AEC, 1954-1960; Stroschein, 1967; INEEL, 2005). All of the radiological areas were within the A&M Area at the TSF. The significant radiological areas in the A&M Area included the A&M Building, Hot Cell Annex, Hot Liquid Waste Treatment Plant, Actuator Building, and the Radioactive Parts Security Storage Area. A map of the TSF is provided in Figure 5-28.

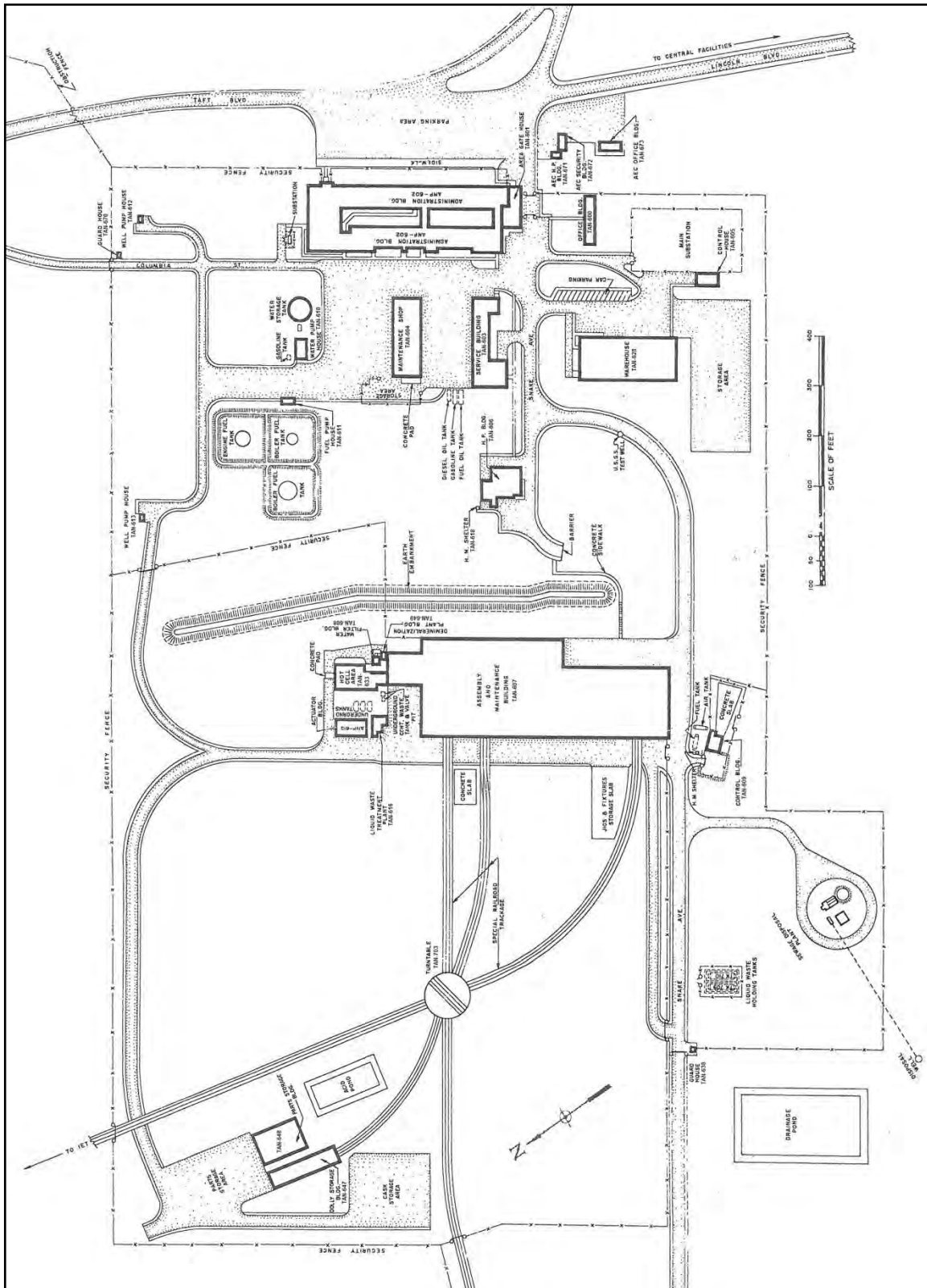

Figure 5-28: Map of the Technical Support Facilities (TSF)

A&M Building (TAN-607)

The A&M Building was approximately a 200 foot by 500 foot, two-story, reinforced concrete building that was constructed in 1954 (Picker, 2001; INEEL, 2005; LOC, 1957-2014). The major parts of the building included the Hot Shop, Warm Shop, Special Equipment Services (SES) Room, Radioactive Materials Laboratory, Storage Pool, Decontamination Room, High Bay Assembly Shop, Metallurgical Laboratory, radiochemistry laboratories, craft shops, and administrative areas (Freeman, 1964; INEEL, 2005; EG&G, 1977). Figure 5-29 presents the floor plan for the A&M Building.

The A&M Building's Hot Shop was the world's largest hot shop, measuring 51-foot-wide, 165-foot-long, and 55-foot-high. Its outer concrete walls were seven-foot-thick with six-foot-thick viewing windows. The Hot Shop was the hub of the A&M Building and was designed to provide a remote maintenance and disassembly area where several manipulators operate together in conjunction with turntables, fixtures, and standard and special tools on the largest and smallest radioactive industrial components. The Hot Shop was also equipped with a 100-ton bridge crane and an Overhead Manipulator (O-Man). Heavy equipment could be brought to this area on rails leading from the outdoor turntable (Freeman, 1964).

The Warm Shop was located adjacent to the Hot Shop, and was a high-ceiling area where test assemblies with minor activity or contamination could be stored and worked on. The Warm Shop facilitated rapid handling of slightly-radioactive (or warm) components. Personnel, wearing protective clothing and working under controlled environmental conditions, were able to perform the same functions of handling, observation, and analysis as performed by the remote facilities in the Hot Shop. As with the Hot Shop, heavy equipment could be brought to this area on rails leading from the outdoor turntable (Freeman, 1964).

Located at the back of the Hot Shop was the SES Room, which was a continuation of the upper level of the Hot Shop. The SES Room could be closed off from the Hot Shop by means of sliding shielding doors. With relative ease, equipment could be decontaminated and repaired in the SES room while other operations were being carried out in the Hot Shop. A control station with a mineral-oil-filled, shielded viewing window serves to control the equipment being serviced in the SES room (Freeman, 1964).

The Radioactive Materials Laboratory (RML), which adjoins the east end of the Hot Shop, is a remote-handling area 10-foot-wide by 35-foot-long used for study, observation, and analysis of fuel elements and smaller radioactive objects. Access from the Hot Shop was gained through the plug door. Delicate, accurate handling and analyzing equipment is employed in the RML. The area is serviced by master-slave manipulators at each viewing window and by two bridge-mounted manipulators that cover the entire cubicle. Special equipment in the RML included: a remotely operated four-kilogram balance having an accuracy of ± 10 milligrams; two Kollmorgen periscopes equipped with cameras; a Bausch and Lomb remote microscope; a GEL periscope; an Elox electron drill; and miscellaneous remotely operated tools, jigs, and fixtures for analyzing and handling the various specialized components (Freeman, 1964).

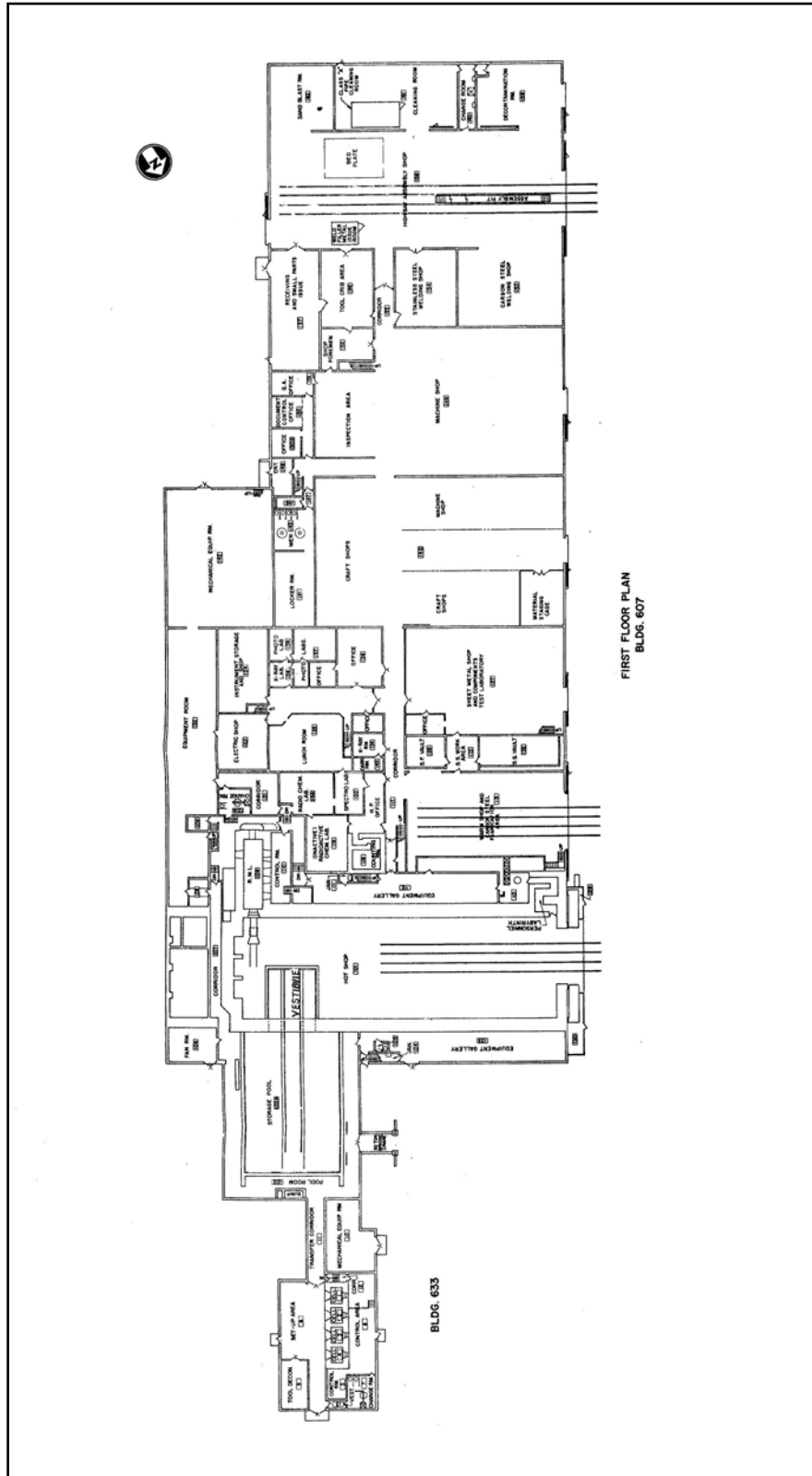

Figure 5-29: Floor Plan of the A&M Building (TAN-607)

Also adjoining the Hot Shop is a 24-foot-deep storage pool. It is connected to the Hot Shop by an extension that passes under a shielding wall. An underwater dolly and track system provides transportation to the main pool (Freeman, 1964).

The Decontamination Room was used for decontaminating parts and equipment, and was located at the south end of the A&M Building adjacent to the High Bay Assembly Shop. Its walls were made of poured, reinforced (ordinary) concrete that were about 1.5-foot-thick. The room was about 39-foot-high and about 32-foot-wide, and was equipped with a 10-ton bridge crane. Acid and neutralizer pits contained fluids used in cleaning operations. Radioactively-contaminated liquid wastes entered an underground drain that went to the Hot Liquid Waste Treatment Plant (TAN-616) (INEEL, 2005).

The High Bay Assembly Shop was maintained in a radiologically-clean condition so that normal unobstructed assembly work could be conducted. This shop was serviced by the four-rail track system and two separate overhead bridge cranes. Initial assembly of major test components took place in the High Bay Cold Assembly Shop, which was also equipped to do large and small machining, welding, and special inspections (Freeman, 1964).

The A&M facility was also equipped with a variety of specialized laboratories. The Chemical Lab (second floor) was equipped to analyze samples, certify materials, and study such problems as turbidity, which occasionally appeared in viewing glass fluid. It had a balance room and an emergency shower. The Metallurgical Lab (next to the Chemical Lab, second floor) had a mobile X-ray unit for inspecting welds (first floor), a plating room, a darkroom for developing X-ray film, a tensile testing machine, and radiograph-making equipment for producing weld reports. The Photographic Lab (first floor) handled standard black/white film and motion pictures. A Radiographic Materials Lab included an Elox block cutter with a remotely-operated balance, a periscope/camera outfit for making remote images, sample cutters, and mounting equipment. This lab was ventilated for negative air pressure and air-filtered with disposable filters (INEEL, 2005).

Hot Cell Annex (TAN-633)

The Hot Cell Annex (HCA) adjoins the A&M Building's storage pool opposite of the Hot Shop, and is used for the preparation and analysis of radioactive metallurgical specimens (Freeman, 1964). These specimens are removed from test assemblies in the A&M Building's Hot Shop or are brought from other parts of the INL Site in casks (Freeman, 1964). The specimens are moved by remote control in a straight line from the pool building, down the corridor, and into the HCA. They traveled on a 5-ton monorail as far as the designated hot cell. After the hot cell analysis had been completed, the item was returned to its transport cask and sent back into the monorail corridor. Here the cask could return toward the pool for storage or out a west-side exit to a waiting transport truck. Alternatively, the cask could move northward and out the north door of the building. There a concrete pad, sheltered by a gabled canopy with a corrugated tin roof, allowed for a transport truck to pick up the cask (INEEL, 2005).

The HCA consists of four shielded hot cells with interconnecting sliding drawers for the transfer of samples (Freeman, 1964). The hot cells have mineral oil-filled lead glass windows. Each hot cell was equipped with a unique selection of work tables, manipulators, and other equipment. All hot cells had air exhausts, floor drains, and a small "lost tool opening" on the east side (INEEL, 2005).

Work spaces within the HCA included a change room, a set-up area, and tool decontamination area. After the ANP program had been canceled, the room in the northwest corner was converted to a photographic darkroom (INEEL, 2005). The mechanical equipment room (Room 10) was in the southwest corner. Figure 5-30 provides the floor plan for the HCA.

Hot Liquid Waste Treatment Plant (TAN-616)

As indicated in Figure 5-28, the TAN-616 was near the north end of the A&M Building. The strategy for dealing with radionuclide-contaminated liquids that accumulated due to ANP Program and STEP operations, decontamination activities, accidents, and other processes was to isolate, treat, and concentrate them in a storage tank. To that end, a complex system of waste drains, pumps, holding tanks, and piping connected the A&M Building labs, hot shops, hot cells, and decontamination shop to the TAN-616 plant. Waste drains came from the IET Facility, the Actuator Building (TAN-615), and the Water Filtration Building (TAN-649) (INEEL, 2005).

The system involved various treatments for the waste (acid and caustic) and an evaporator to drive off water. Initially, the system had three holding tanks (V-1, V-2, and V-3), but another (V-9) was added later. The first three tanks were buried underground on the west side of the plant building. These held wastes being delivered for treatment and concentration (INEEL, 2005)

The large evaporator vessel was the central feature of the concentration process. Beginning in 1958, sludge from the bottom of the vessel was periodically removed to tanks located southwest of the A&M Building in a field on the south side of Snake Avenue. After years of operation, the vessel cracked from stress corrosion. The contents leaked onto the floor of the pit. The vessel was removed and repaired, but eventually cracked once more. Again, leaks ended up on the floor of the pit. The facility was shut down in 1970, but waste in the process system at the time remained where it was. A new system, called the PM-2A, was installed, but operating difficulties shut it down in 1975. Again, untreated waste remained in process lines (INEEL, 2005)

Actuator Building (TAN-615)

As indicated in Figure 5-28, the Actuator Building was just outside the north end of the Hot Liquid Waste Treatment Plant. GE designed the Actuator Building in November 1956 and built it soon after (INEEL, 2005). For the ANP Program, the Actuator Building served as the location for testing prototype actuator mechanisms, the motors, instruments, electromagnets, and other devices that moved control rods in and out of the HTRE reactors (INEEL, 2005). The TAN-615 was later renamed the TAN Fuel Handling Facility, but the date when that transition occurred is unknown (Waste Management, 1974, PDF p. 373). In March 1963, the TAN-615 was handed over to the Phillips Petroleum Company (Phillips), which had the STEP contract. Upon turnover, Phillips performed a thorough inspection and found the entire building to be highly contaminated with alpha radioactivity (TAN HP Report, Dec 1963, PDF pp. 45-49). The alpha radioactivity was later determined to be from uranium (Dierks, 1963).

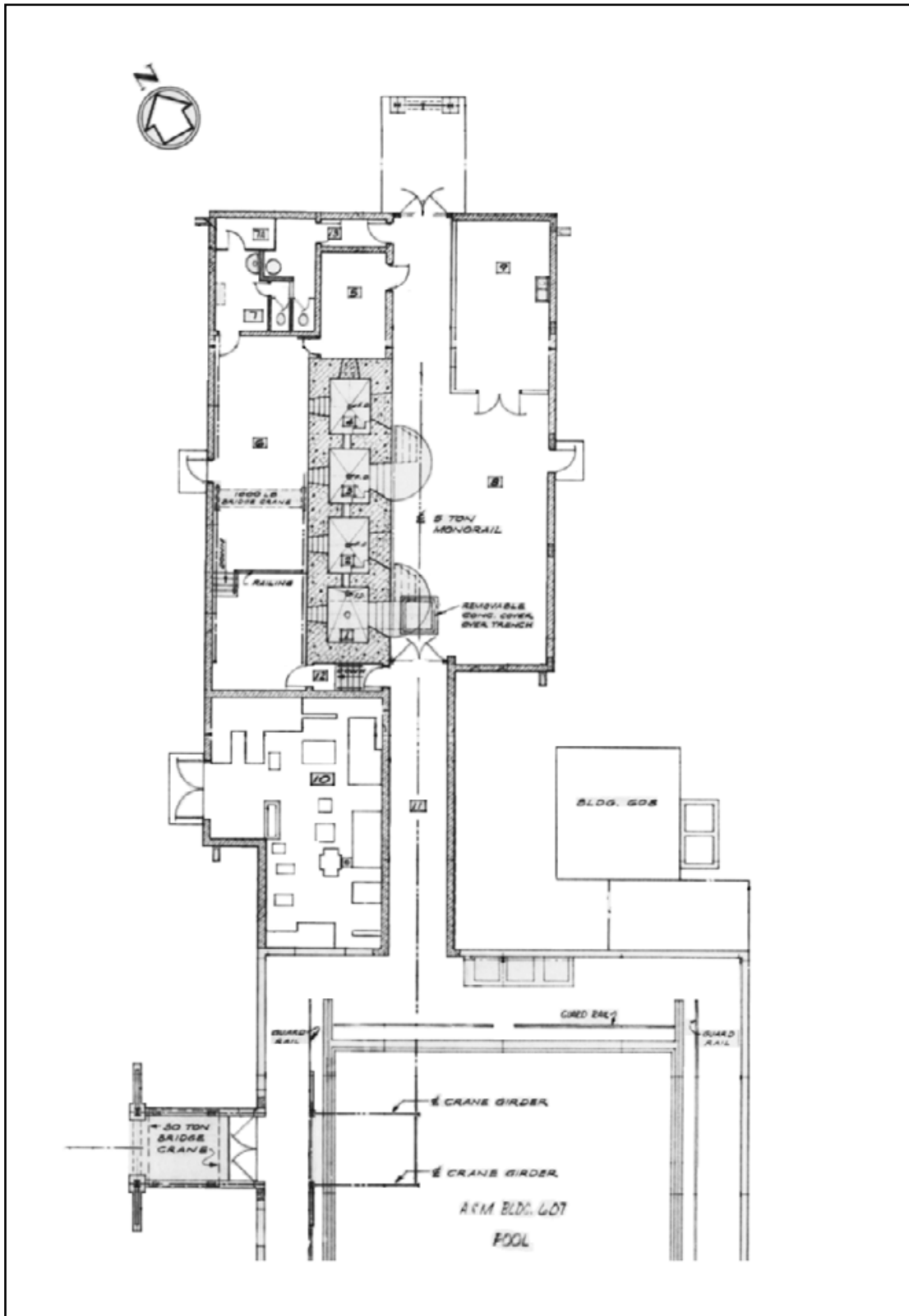

Figure 5-30: Floor Plan of Hot Cell Annex (TAN-633)

Radioactive Parts Security Storage Area (TAN-647 and TAN-648)

Storage buildings (TAN-647 and TAN-648) and the adjacent storage pads are known as the Radioactive Parts Service and Storage Area (RPSSA). These buildings are in the northwest portion of the TSF area. The area has residual contamination from earlier projects, including the HTRE-2 and HTRE-3 reactors. The buildings and contaminated areas are marked with perimeter fencing and warning signs. The gates and buildings are locked when access is not required (ORAUT-TKBS-0007-2).

Access to the RPSSA was available either by road or by rail, depending on the item being stored (INEEL, 2005). Dollies went via rail on a new set of tracks leading from the turntable directly into TAN-647, named the Dolly Storage Building. Access by road was from an existing road leading to the north end of the A&M Building. Items could be stored inside TAN-648, named the Parts Storage Building, or set outdoors. An area southwest of TAN-647 was designated for transport cask liners. (INEEL, 2005).

5.1.3.2 IET Facility

The IET Facility was located approximately one mile north of the TSF. When this facility was built for the ANP Program, it was named the Initial Engine Test (IET) Facility, but was later renamed Initial Engineering Test (IET) Facility during the STEP era (Ref: PTR-589 – Not Yet In SRDB). Figure 5-31 provides an aerial photograph of the IET Facility. Figure 5-32 provides a map of the IET Facility.

The IET Facility was built as a shielded test facility to prove that heat from a nuclear energy source could run a turbojet engine for the ANP Program (Stacy, 2000). The IET Facility included shielded underground control and equipment rooms, jet engine fuel storage, water-cooling facilities, and an effluent exhaust gas system. The facility was unique among other reactor installations in that the radiation shielding enclosed the personnel rather than the reactor, which made the facility very flexible for adapting to testing and operating power plants of varying size. The power plant could be viewed directly from the control room through either of two periscope eye-pieces. Personnel could be dropped off or picked up within 100 feet of the power plant by a shielded locomotive. The locomotive was equipped with a shielded retractable hatchway in the floor of the cab that would mate with a hatch that was between the two center rails. Personnel could then travel to and from the control room via an underground tunnel (General Electric, 1953).

Three U-235-fueled nuclear reactor assemblies, called Heat Transfer Reactor Experiments (HTREs), were operated at the IET Facility during the ANP Program era (DOE, 1991; Thornton, Jun1962). The three HTRE assemblies were designated HTRE-1, HTRE-2, and HTRE-3 (Thornton, Jun1962). The HTRE assemblies were mounted on a four-track railroad dolly (DOE, 1991). Each test for the HTRE assemblies was designated with an Initial Engine Test (IET) number, and some of the IETs would have multiple runs (DOE, 1991). After an IET run, the shielded locomotive hauled the HTRE assemblies back to the TSF Hot Shop in the TAN-607 building, where specialists were ready to examine, refuel, maintain, and repair the reactor and engine (INEEL, 2005). The HRTE-1 reactor went critical for the first time on November 4, 1955, for tests prior to connection with the turbojet engines (Stacy, 1995; Thornton, Feb1962). On December 30, 1955, the HRTE-1 reactor went critical for the first time with the turbojet engines connected to it (Stacy, 1995). Tests involving the HTRE-1,

HTRE-2, and HTRE-3 reactor assemblies went on until the ANP Program was cancelled in March 1961 (DOE, 1991).

On December 28, 1961, the AEC initiated another nuclear safety program that used the IET Facility; that program was called the Safety Test Engineering Program (STEP) (INL, 1963). The portion of the STEP that used the IET Facility was the reactor test series called Systems for Nuclear Auxiliary Power (SNAP) Transients (SNAPTRAN) Program. During the SNAPTRAN Program, the Initial Engine Test (IET) Facility was renamed Initial Engineering Test (IET) Facility (INL, 1963; Ref: PTR-589 – Not Yet In SRDB).

The SNAPTRAN Program was designed to provide nuclear safety information applicable to SNAP 10A/2 reactor systems (AEC, Apr1967). The SNAP 10A/2 reactors were zirconium-hydride-uranium (ZrH_x-U) fueled, sodium-potassium alloy (NaK) cooled, and beryllium-reflected (Bentzen, 1963). The program consisted of the SNAPTRAN-1, -3, and -2 test series, which were conducted in that order. Each of these tests investigated the transient behavior of the SNAP 10A/2 fuel under large-transient, power-excursion conditions (AEC, Apr1967). The SNAPTRAN reactors were mounted on a four-rail flatcar so that the reactors could be returned to the TAN Hot Shop in the TAN-607 building for inspection and investigation (DOE, 1991). The SNAPTRAN-1 tests investigated the nondestructive transient reactor response to large-reactivity additions. This series of tests was conducted under conditions approaching, but not resulting in, fuel damage (AEC, Apr1967). The SNAPTRAN-3 destructive test investigated the transient reactor behavior and the radiological consequences of reactor destruction under conditions simulating accidental water immersion (AEC, Apr1967). The SNAPTRAN-3 test was conducted at 11:44 a.m. on April 1, 1964, with extensive radiological and meteorological support, surveillance, and controls (DOE, 1991). The SNAPTRAN-2 portion of the program investigated the dynamic behavior of the zirconium-hydride-uranium fuel under the influence of reactivity additions large enough to produce destruction of the core (AEC, Apr1967). The SNAPTRAN-2 test was conducted at 9:51 a.m. on January 11, 1966 with extensive radiological and meteorological support, surveillance, and controls (DOE, 1991).



Figure 5-31: Aerial Photograph of the IET Facility (facing east)

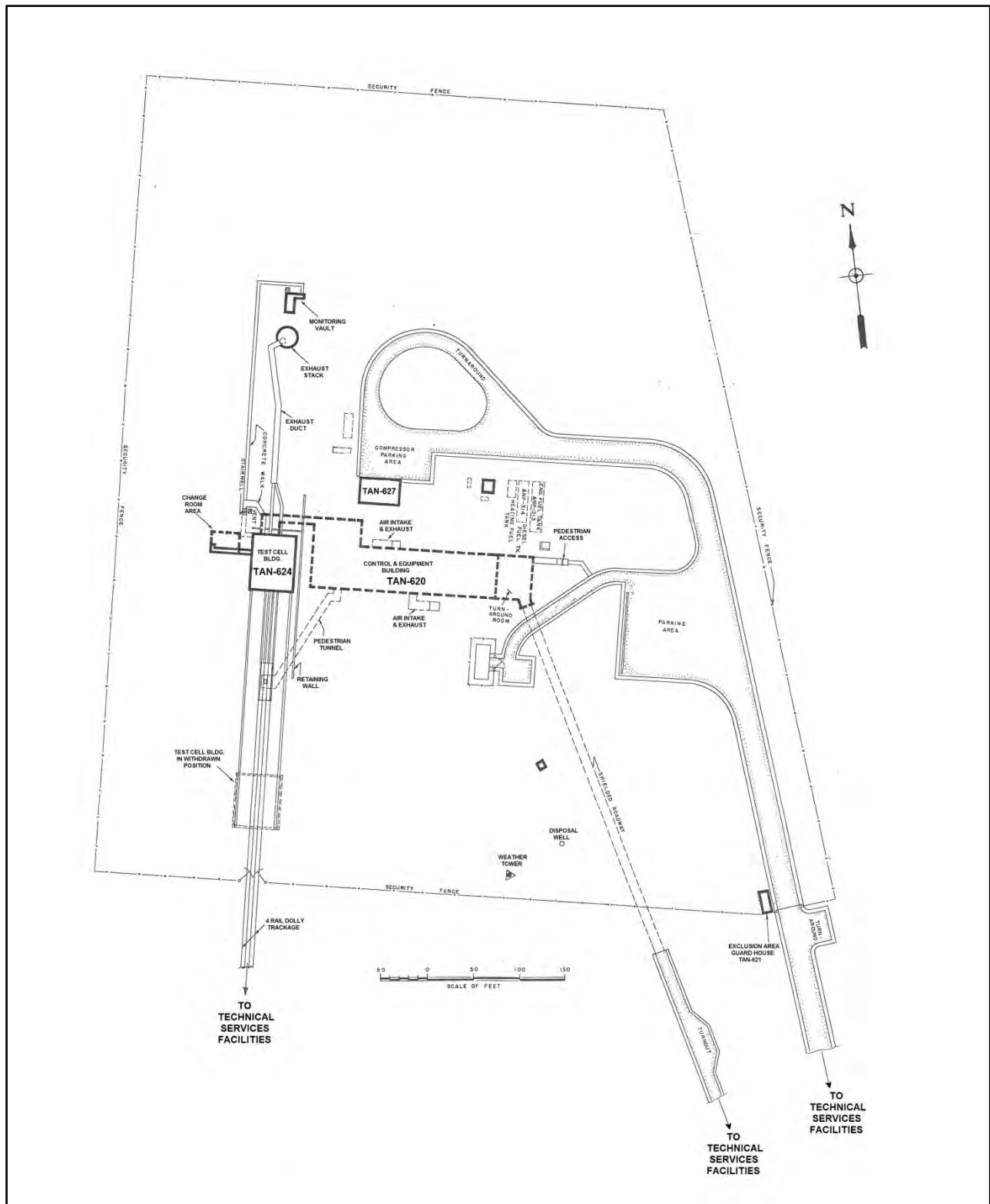

Figure 5-32: Map of the IET Facility

5.1.3.3 Flight Engine Test (FET)/Loss-Of-Fluid Test (LOFT) Facility

The FET/LOFT Facility was located approximately 1.15 miles west-northwest of the TSF. A map of the FET/LOFT Facility is provided in Figure 5-33.

The FET Facility was originally constructed to serve as an aircraft hangar facility for a huge nuclear powered airplane, as part of the ANP Program (Stroschein, 1967). The primary structure in the FET Facility was the aircraft hangar, the TAN-629 building. The TAN-629 building is a large structure that measures 240 feet by 320 feet, and has a maximum height of 99 feet. Because a nuclear-powered airplane was never built before the cancellation of the ANP Program, the FET Facility was never used for its designed purpose. After the ANP Program, the TAN-629 building was used as a “clean” storage area, and health physics work in that area normally consisted of surveying materials going in and out of the building for possible contamination (Stroschein, 1967).

For a relatively brief period (approximately 1962–1964), the FET/LOFT Facility was referred to as the STEP Area. During that period, little radiological work was performed at this area, and that work was likely limited to the storage of materials in TAN-629.

In 1964, construction began on the LOFT reactor (INEEL, 2005). Sometime after that, the FET Facility was renamed the LOFT Facility. The LOFT reactor at the TAN-650 building was a centerpiece in the safety testing program for commercial power reactors. The reactor was a scale model of a commercial pressurized water reactor (PWR) that was built to explore the effects of Loss-of-Coolant Accidents (LOCAs). Thirty-eight nuclear power tests were eventually conducted at the LOFT Facility with various accident scenarios, including the accident at Three Mile Island (TMI). Among other goals, the program investigated the capability of emergency core cooling systems to prevent core damage during a LOCA. Experiments at LOFT simulated small-, medium-, and large-break LOCAs, sometimes complicated with other events such as loss of off-site power. However, the first nuclear test at the LOFT reactor did not take place until December 10, 1978, which is outside the period under evaluation for this SEC report (INEEL, 2005).

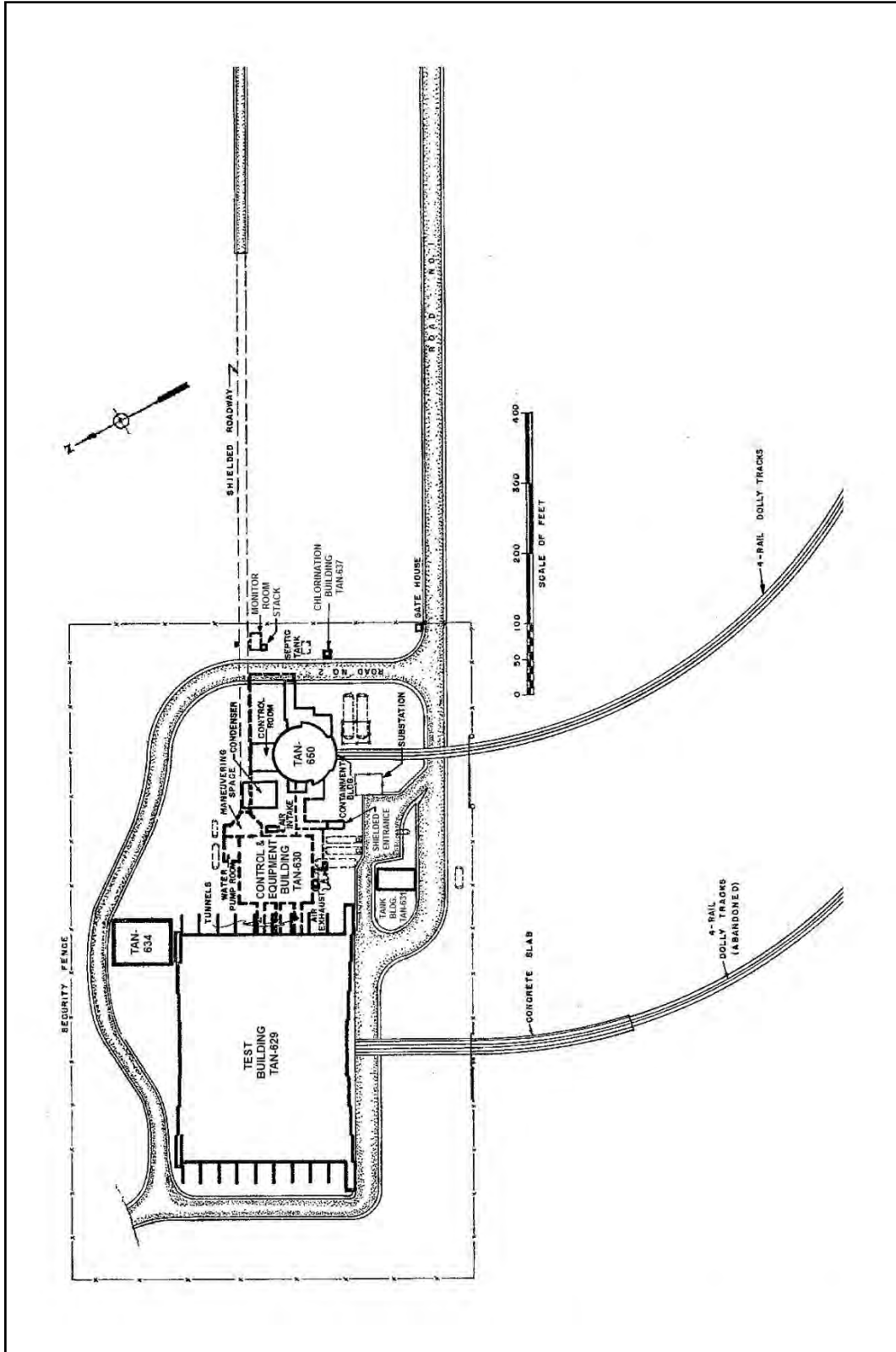

Figure 5-33: Map of the FET/LOFT Facility

5.1.3.4 Low Power Test Facility (LPTF) Area

The LPTF Area, which included the LPTF and the Shield Test Pool Facility (STPF), was approximately 1.25 mi south-southeast of the TSF. A map of the LPTF Area is provided in Figure 5-34. A photograph of the LPTF Area is provided in Figure 5-35. The first facility at LPTF Area was the LPTF in 1958. The Shield Test Pool Facility (STPF) in the west side of the LPTF Area was built as part of the ANP Shielding Experimentation Program; in 1963, the pool facility was later modified for the Experimental Beryllium Oxide Reactor (EBOR). Note the photo in Figure 5-35 is dated later than the map in Figure 5-34; the far left of the photo shows the additions to the STPF that were added for EBOR.

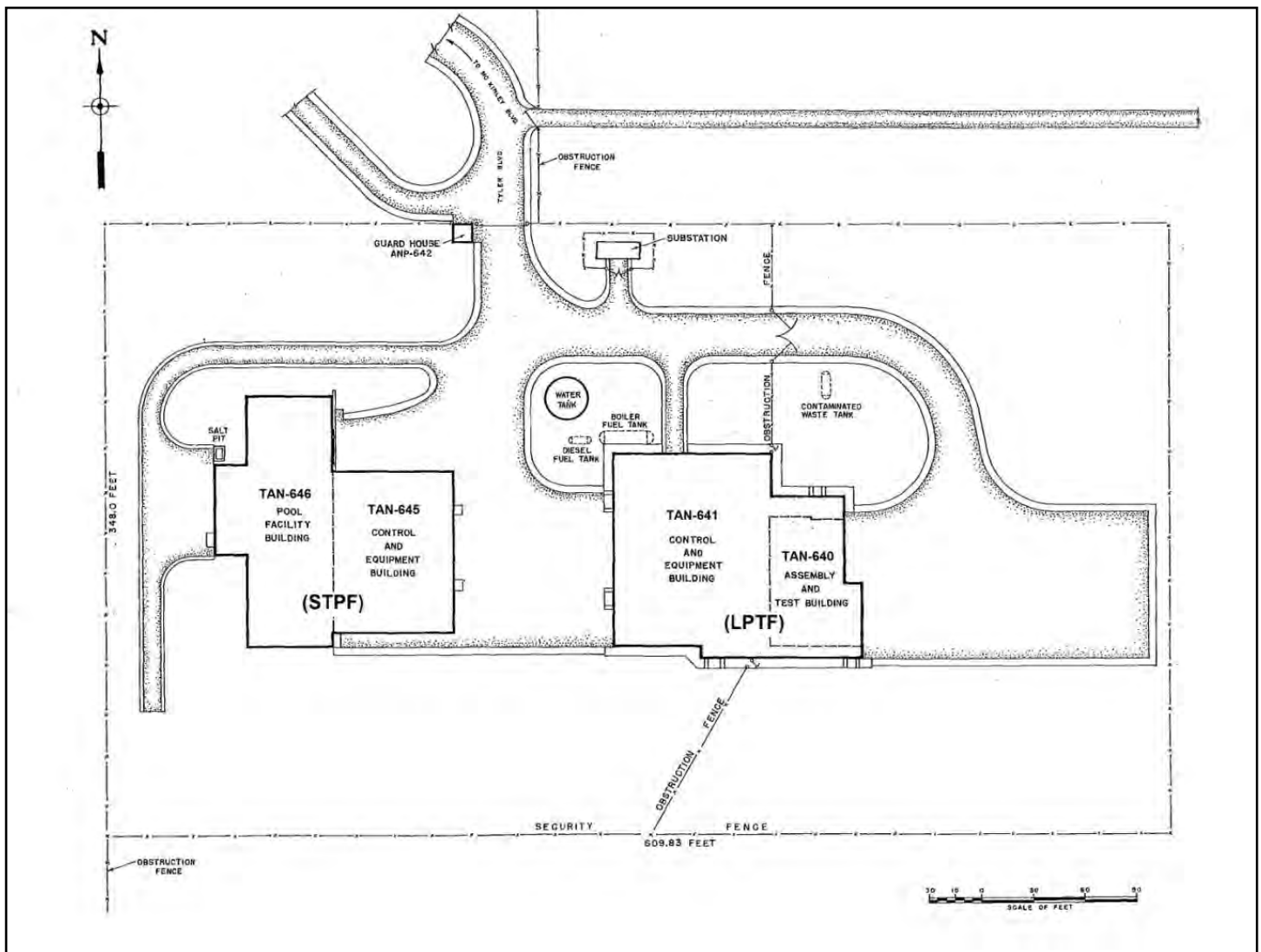

Figure 5-34: Map of the LPTF Area



Figure 5-35: Photograph of the LPTF Area (looking northwest)

Low Power Test Facility (LPTF)

The LPTF was used to conduct several low-power (less than 100-W) reactor research programs during the period 1958–1973. The LPTF contained two shielded cells with three independent control rooms and necessary support facilities. The north cell was called the Critical Experiment (CE) cell (Room 101); the south cell was the Initial Criticality (IC) cell (Room 101). The test cells are made of poured concrete construction with a 4-foot-thick wall between them. The walls between the cells and the control room are 5-feet thick and 30 feet high. The outside wall of the IC cell is 2-feet thick, and the outside wall of the CE cell is 3-feet thick and 30 feet high (Kunze, 1970; ORAUT-TKBS-0007-2). The construction of the facility was such that more than one reactor program could be running at the LPTF at the same time. Heavy experiment pieces could be moved in or out of each cell through large roll-up doors on the east side of the LPTF (ORAUT-TKBS-0007-2).

The seven nuclear reactors that operated at the LPTF are listed in Table 5-5 below, all of which were uranium-fueled reactors (Stacy, 2000; Becar, 1961; INEEL, 2005).

Semiscale also operated at the LPTF between 1970 and 1971 (INEEL, 2005). Semiscale was a non-nuclear apparatus that simulated the heat of a nuclear reactor to study thermal-hydraulic phenomena during postulated loss-of-fluid accidents.

Table 5-5: Nuclear Reactors that Operated at the LPTF			
Nuclear Reactor Name	Abbreviation or Acronym	First Used	Last Used
Cavity Reactor Critical Experiment	CRCE	05/17/67	early-1970s
Critical Experiment Tank	CET	1958	1961
Fast Spectrum Refractory Metals Reactor	710 Reactor	Mar 1962	1968
High Temperature Marine Propulsion Reactor	630-A Reactor	1962	1964
Hot Critical Experiment	HOTCE	1958	1961
Spherical Cavity Reactor Critical Experiment	SCRCE	Nov 1972	1973
Thermal Reactor Idaho Test Station	THRITS	1964	1964

Source: Stacy, 2000; INEEL, 2005

Shield Test Pool Facility (STPF)/Experimental Beryllium Oxide Reactor (EBOR)

The STPF was initially built to perform shielding experiments in support of the ANP Program (INEEL, 2005). The STPF was designed to do radiation-scattering tests in water utilizing the Susie Reactor as its radiation source (INEEL, 2005). The Susie Reactor was a low-power swimming pool reactor that had a fuel loading of approximately 4 kg of aluminum-clad U-235 (General Electric, 1961; INEEL, 2005). STPF had two pools to allow testing to proceed in one while mock-up work could be done in the other.

After the ANP Program was cancelled in 1961, the Susie Reactor was utilized for other projects at the INL site (INEEL, 2005). However, by the end of 1962, the Susie Reactor was no longer in use. In June 1963, construction began to adapt the STPF for the EBOR, which involved removing the Susie Reactor and draining the STPF pools (INEEL, 2005). In December 1966, the EBOR project was cancelled before the reactor could ever be loaded with nuclear fuel.

5.1.4 Misc. Reactor Areas (ARA, OMRE, SPERT)

ATTRIBUTION: Section 5.1.4 was completed by Mitch Findley, MJW Corporation. All conclusions drawn from the data regarding the Misc. Reactor Areas were peer-reviewed by the individuals listed on the cover page. The rationale for all conclusions in subsequent sections of this document devoted to the Misc. Reactor Areas are explained in the associated text.

5.1.4.1 Auxiliary Reactor Area (ARA)

The ARA was initially known as the Army Reactor Experiment Area (AREA), then the Army Reactor Areas (Redesignation, 1963) before becoming known as the Auxiliary Reactor Area. In February 1954, the Army was assigned the task of “developing nuclear power plants to supply heat and electricity at remote and relatively inaccessible military installations.” In 1955, the Department of Defense notified the AEC of the need for a nuclear power plant with the following initial criteria: constructed of air-transportable components, and capable of supplying about 200 kilowatts of electricity and 400 kilowatts of heat. These plants would be used at military sites to supply power for radar equipment, and heat for offices, barracks, and other buildings. A military-oriented program began in 1957 at INL to design and test a mobile power reactor that was easily transported and operated with minimal maintenance and technical support (Stacy, 2000). ARA was located on 20 acres with four separate operational areas: ARA-I, ARA-II, ARA-III, and ARA-IV.

Construction on ARA-I began in 1957. ARA-I was built to support the Stationary Low Power Reactor (SL-1) which was located in ARA-II. ARA-I was strictly a support facility which included two hot cells (Building 626) (see Figure 5-36) and a maintenance/metallurgical shop (Building 627) (AEC, 1954-1986). ARA-I was initially used in direct support of the Army reactors for examining fuel elements and preparing irradiated specimens for evaluation. Beginning in January 1966, ARA-I was used for a variety of technical support services for INL’s developmental research programs. Examples include the Test Reactor Area neutron cross-section program and separation of some high-activity radionuclides. In 1968, the ARA hot cell was extensively modified for work separating Pa-233, a high-specific-activity alpha-emitter (Progress Report, 1968). Modifications included upgrades to the ventilation system and addition of isolation boxes for the Pa-233. The facility was used intermittently for storage and other miscellaneous reasons until the mid-1980s.

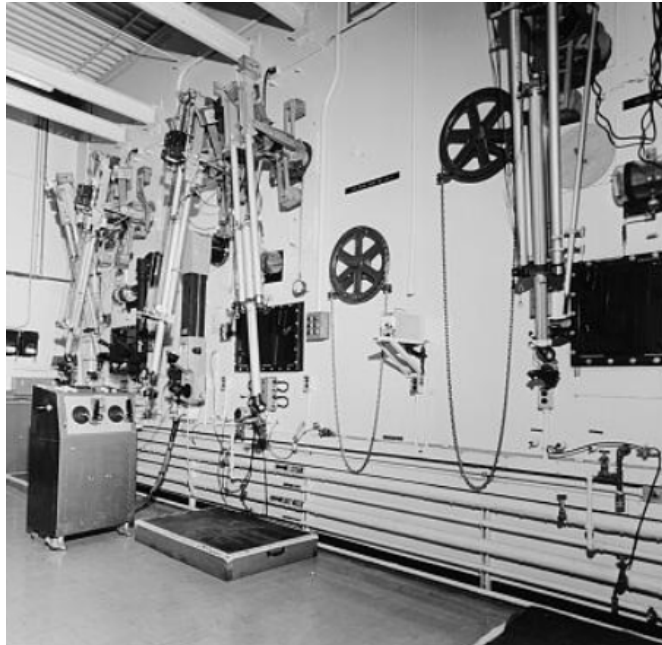

Figure 5-36: ARA-I Hot Cell Wall with Viewing Windows and Remote-Handling Manipulators

Construction on ARA-II began in 1957. SL-1 was initially named the Argonne Low Power Reactor (ALPR) and was to be the prototype low-power boiling water reactor that was to be a “package” power plant at small remote locations, such as the Distance Early Warning (DEW) installations. The reactor design was to allow for three years of operation between fuel loadings. ALPR achieved criticality at 10:30 pm on August 11, 1958 but was formally dedicated on December 2, 1958, at which time it was re-designated SL-1 (see Figure 5-37). After operating intermittently for approximately two years, on January 3, 1961 an accident (the first fatal nuclear accident in the U.S.) destroyed the SL-1 reactor (SL-1 Report, 1961; SL-1 Records, 2009; SL-1 Chronology, 1961). At that time, ARA-1 served as the staging area for the emergency response and subsequent decontamination efforts. In 1961 and 1962, a massive dismantling, disposal, and clean-up of the SL-1 site occurred. The reactor building was removed and the support facilities and office buildings were decontaminated. A dedicated burial ground was created not far from the reactor facility to minimize external radiation exposure as well as contamination-control issues that would have resulted from transporting the materials to the INL Burial Ground located approximately 16 miles away (RWMC History, 1985).

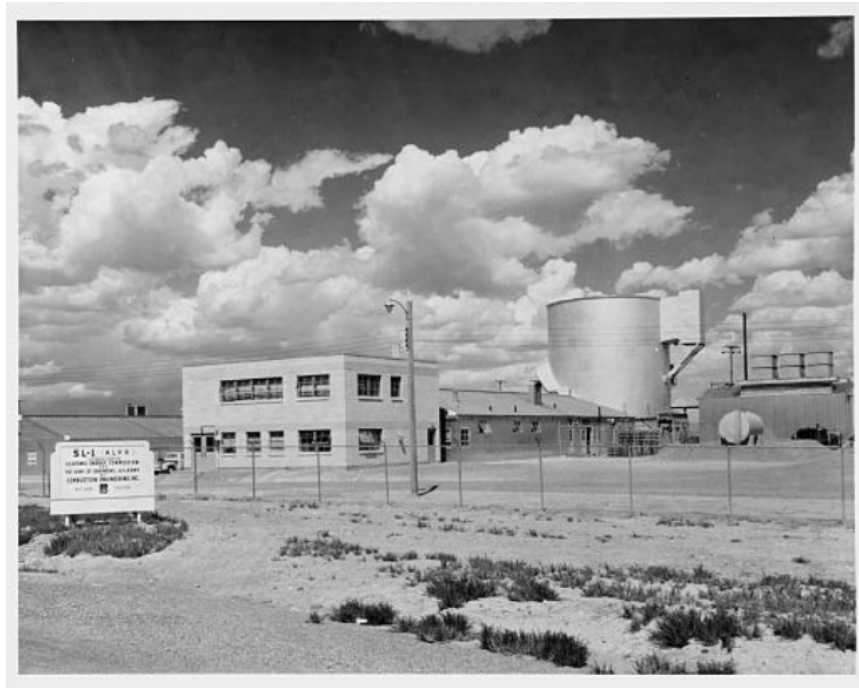

Figure 5-37: SL-1 in 1960 (Prior to 1961 Accident)

ARA-III was completed in 1959 and was the location of the Army's Gas Cooled Reactor Experiment (GCRE) (GCRE Progress Report, 1959). The GCRE was a water-moderated, nitrogen-cooled low-power reactor that generated heat but no electricity. It was the first phase in developing a truly mobile nuclear power plant and achieved criticality on February 23, 1960. After accomplishing its "proof of principle" phase of a mobile nuclear reactor, it was placed in standby mode on April 6, 1961 (Stacy, 2000).

ARA-IV housed the Mobile Low Power Reactor No. 1 (ML-1) shown in Figure 5-38. ML-1 followed the GCRE's "proof of principle" by developing an entire plant that could be transported by cargo planes or tractor trailers. ML-1 was remotely operated from a control room located approximately 500 feet from the reactor in order to avoid extensive shielding. The 500-foot distance to the control room represented the personnel exclusion zone during reactor operation. The reactor achieved criticality on March 30, 1961 but was only operational less than 1000 hours until it was shut down in 1964 (GCRE Final Report, 1964).

By late 1965, the Army phased out ML-1 and the entire Army Reactor Project at INL due to questions of cost effectiveness, lack of need, and increasing resource needs for the Vietnam War. In mid-1967, a small pulsed reactor named FRAN, which was capable of supply bursts of high intensity fast-neutron and gamma radiation was transferred to INL from the Nevada Test Site. FRAN was sited at the former ML-1 reactor building and was employed for a short time to test the performance of new detection equipment being developed for reactor-control purposes (Long, 1969). FRAN achieved criticality on August 28, 1968. The reactor was moved to the Lawrence Radiation Laboratory in Livermore, California in June 1970.

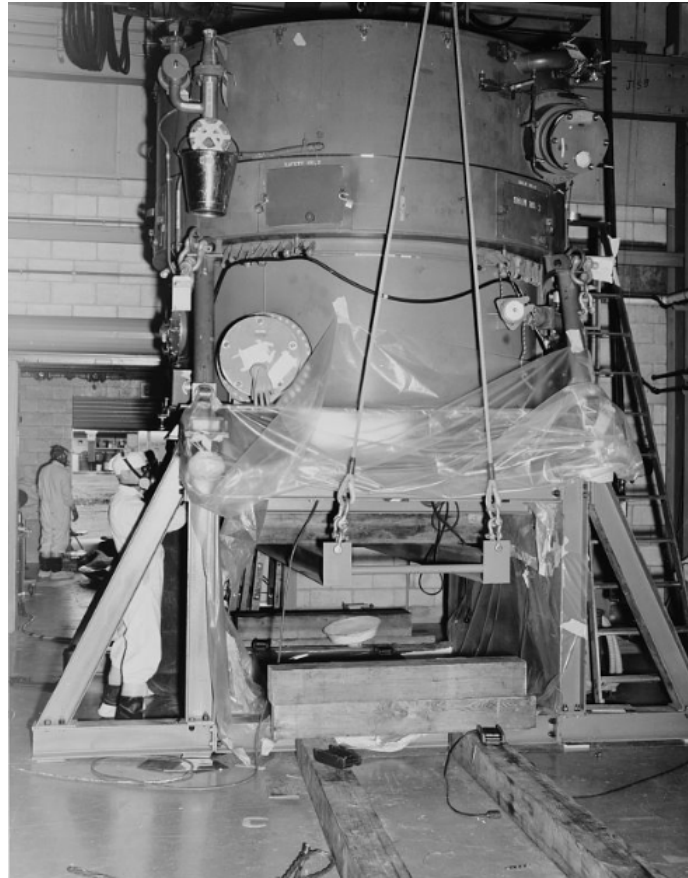

Figure 5-38: ML-1 After Being Moved to ARA-III

5.1.4.2 Organic Moderated Reactor Experiment (OMRE)

A reactor concept conceived and partially-financed by Atomics International, the Organic Moderated Reactor Experiment (OMRE) was constructed and operated for several years to demonstrate the technical and economic feasibility of using a liquid hydrocarbon, typically a polyphenyl, as both coolant and moderator. The primary purpose of the reactor was to study the radiation and thermal stability of the organic materials employed, and the associated physical property changes under actual reactor operating conditions (OMRE, 1957). The concept of an organically-moderated reactor was conceived during the wartime Manhattan Project, but due to the lack of an immediate need for power reactors and the general unavailability of enriched uranium, serious consideration did not occur until about 1953.

The AEC had, since approximately 1953, continuously funded (albeit at a modest level) an organic reactor development program. Due to the technical uncertainties associated with the use of an organic material as a reactor coolant, a very large fraction of the development effort was devoted to the determination of coolant properties and stability data. The design and construction of OMRE began in mid-1955 because of the recognized need for the test of an organic fluid under actual reactor operating conditions. The facility was sited just east of the Central Facilities Area. The OMRE facility included no provisions for the generation of electrical power and the heat produced was dissipated to the atmosphere using air-cooled heat exchangers. During the period from 1955 to 1958, testing on circulating organic fluids was performed with the most extensive reactor loop experiments occurring at the Materials Testing Reactor. Experiments that did not involve reactor loops were primarily focused on the measurement of heat transfer and the hydrodynamic characteristics of organic coolants. This work was done both at Atomics International and Aerojet-General.

The first OMRE criticality occurred on September 17, 1957. The reactor operated almost continuously until 1959, except for a period of several months near the end of 1958, when a new core was installed. Considerable information was obtained from OMRE on organic coolant stability and heat transfer conditions in the core. The operation of the reactor demonstrated the expected low organic radiation decomposition rates, low induced radioactivity, low corrosion rates, and the technical feasibility of designing and operating organic-cooled reactor plants. In all respects, the plant behaved as anticipated without occurrence of any unforeseen problems (AEC Annual Report, 1960).

On November 16, 1960, an experiment was conducted to determine the feasibility of open-air burning of contaminated solvents that had accumulated at the OMRE facility. Approximately 400 gallons of liquid composed of diesel oil, xylene, methyl-chloroform, and a small amount of water were placed in an open vessel and ignited.

OMRE was phased out in April 1, 1963 after accomplishing its intended purpose. Due to the minimal cost allowed for the construction of OMRE, the Experimental Organic Cooled Reactor (EOCR) was designed to extend and advance the OMRE studies (EOCR, 1959); however, the project was halted near the end of construction in December 1962 when the AEC determined that an organic-cooled reactor was not a significant improvement over other types of nuclear power reactors. The EOCR was sited near OMRE. One successful result of OMRE program was the municipal power reactor at Piqua, Ohio that operated from 1963 to 1966 (AEC, Jan-Dec1967).

5.1.4.3 Special Power Excursion Reactor Tests (SPERT)

Since 1955, the vast majority of the AEC's program for investigating the safety of water-cooled reactors has been centered at INL, when the Phillips Petroleum Company began reactor safety studies in the SPERT-1 reactor. Operating responsibility for the safety program was transferred to Idaho Nuclear Corporation in 1969 and reassigned to the Aerojet Nuclear Company in July 1970. These reactors were designed to operate at very high peak power for short periods of time. The SPERT tests contributed to the development and better understanding of engineering reactor safety control systems (NRTS Facilities, 1973).

Early research centered on understanding the behavior and consequences of the reactivity (runaway power) accidents (SPERT-I, 1961). Four SPERT reactors were constructed and tested in an effort to understand the mechanisms that resist power increases and terminate runaway power conditions. These reactors were designed and operated beyond their normal safety limits to study a wide range of variables, such as core configuration, coolant flow and reflection, moderation, void, and temperature coefficients. Through 1962, most SPERT tests were performed with reactor cores of plate-type fuels, in which the highly-enriched uranium was alloyed and clad with aluminum or stainless steel in thin plates. A test of rod-type, slightly-enriched uranium that is more like the fuel found in the nuclear power industry was carried out in SPERT I in 1961 (SPERT-I, -II, and -III, 1957). By mid-1964, the SPERT project had shifted almost entirely to rod-type fuels. The SPERT reactor experiments fell into four major classifications:

1. Static experiments to determine core characteristics, such as void and temperature coefficients
2. Step tests in which the system is suddenly made supercritical
3. Ramp tests in which power is increased at a constant rate
4. Stability tests that may involve either spontaneous or externally-induced oscillations

These tests were performed under various conditions of temperature, pressure, and coolant flow on cores of differing designs (SPERT Program, 1957). All operations were conducted from a central control building located approximately one-half mile from each reactor (see Figure 5-39) (AEC, 1954-1986). The vast majority of the SPERT tests were conducted well below the threshold of core damage. Fuel damage was sustained in only a few tests.

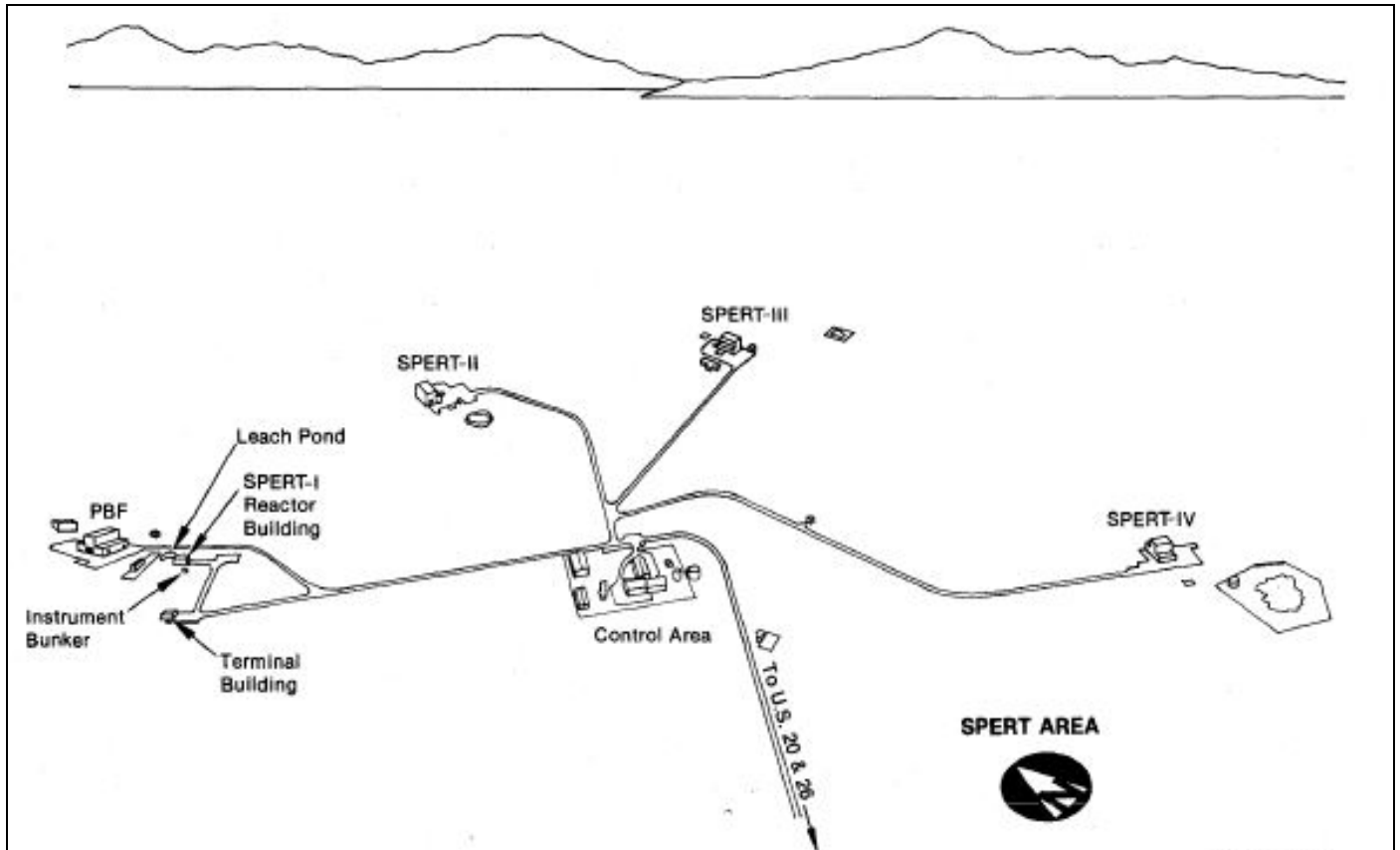

Figure 5-39: SPERT Area

SPERT-I start-up was on June 11, 1955 with operations completed in 1964. It was a simple open-tank (4-foot diameter/14 feet deep), light-water moderated and reflected reactor located in a pit below grade. A bridge across the shield tank supported the drive mechanisms for the five cadmium control rods, instrumentation systems, and a closed-circuit television that allowed control room operators to view the reactor in operation. The SPERT-I tests were characterized by sudden power spikes arrested by shutdown or the self-limiting tendencies of the reactor itself. No provisions for heat removal or coolant circulation through the core were included. In the roughly ten years of operations, approximately 1300 kinetic tests were performed with six different reactor cores. After 1962, the primary emphasis was placed on extending the exploratory transient series of tests into a series of destructive transient tests. In 1954, a 2.6 millisecond excursion at the Boiling Water Reactor Experiment, BORAX-I, produced an explosion that completely destroyed the reactor. Thus, there was considerable interest in studying the period region up to 2.6 milliseconds, which at that time was relatively unexplored (SPERT Program, 1957). The reason for this change in testing at SPERT-I was that other SPERT reactors (i.e., SPERT-IV) became operational. Prior to that time, care had been taken not to do serious damage to SPERT-I. Significant events at SPERT-I included:

- A deliberate 2,300-megawatt power burst on November 5, 1962 that destroyed the highly-enriched uranium metal plate core and distorted the reactor vessel. This destructive test provided valuable data for simplification of safety design features. SPERT-I was rebuilt and used low-enriched uranium rod fuel afterward.

- A deliberate 17,400-megawatt power burst on November 12, 1963 using a low-enrichment (4% U-235) core of uranium oxide pins that successfully withstood the test without causing expulsion of water from the tank or damage to the reactor.
- A deliberate 35,000-megawatt power burst on April 14, 1964 (4% U-235 core) to demonstrate the damage-resistant capabilities of uranium oxide fuel pins, and that the failure of just a few pins would reduce the expected energy release, thereby protecting the rest of the core (NRTS Facilities, 1973).

The November 12, 1963 and April 14, 1964 tests were major safety milestones in the nuclear power industry that employs low-enrichment uranium oxide fuel in light-water-cooled reactors. Figure 5-40 shows a photo of the SPERT-I facility; note the instrument bunker under the soil berm on the side of the reactor building.



Figure 5-40: The SPERT-I Facility

SPERT-II start-up was on March 11, 1960 with operations completed in 1964. Unlike SPERT-I, it consisted of a closed, pressured water reactor with a coolant flow system designed for operation with either light or heavy water. It also had a much larger tank (10 feet diameter/24.5 feet deep). SPERT-II was not designed to operate at high temperatures and pressures; 375 psi and 400° F were upper limits. Flow rates up to 20,000 gallons per minute were achievable with SPERT-II. Coolant flow could be directed either upward or downward through the reactor core at velocities up to 25 feet per second to establish desired initial conditions prior to transient testing of the reactor (SPERT-I, -II, and -III, 1957).

SPERT-III start-up was December 19, 1958 with operations completed in 1968. The reactor was originally planned as the third in the series of SPERT reactors but was the second to be constructed. It was considered to be the most versatile facility yet developed for studying the inherent safety characteristics of nuclear reactors because it was designed for high pressures and temperatures. It provided the widest practical range of control over temperature, pressure, and coolant flow. Pressures from atmospheric to 2,500 psi, water temperatures from 68° to 670°F, and coolant flow rates ranging from zero to 20,000 gpm with heat-removal capacities up to 60,000 kilowatts for durations of 30 minutes were attainable with SPERT-III (SPERT-III, 1961).

SPERT-IV start-up was July 24, 1962 with operations completed in 1970. Unlike the other SPERT reactors, it was a twin-pool facility (open-tank) for detailed studies of reactor stability as affected by varying conditions, including forced coolant flow, variable height of water above the core, hydrostatic head, and other hydrodynamic effects. Most specifically, SPERT-IV made detailed studies of phenomena of instability first observed in the 1,300 excursions conducted at SPERT-I. The small size of the SPERT-I tank necessitated construction of the larger SPERT-IV facility in order to pursue further investigations of instability phenomena. Of particular interest was continuing the investigation of power instability under certain conditions during which there was boiling water in the core (SPERT-IV, 1962).

SPERT-IV was modified with a Capsule Driver Core to allow fuel samples to be inserted into a test hole in the center of the reactor core. The modified core accommodated various experimental capsules that contained fuels for transient response testing. The Capsule Driver Core operated on a transient basis with transient bursts lasting on the order of milliseconds. It did not accumulate large inventories of long-lived fission products. The total energy released per test was usually less than 300 megawatts. The Capsule Driver Core operated for several years in SPERT-V to gain information on fuel destructive mechanisms pending completion of the Power Burst Facility (SPERT Tests, 1965). Construction of the Power Burst Facility was to extend the reactor safety studies at SPERT-I; start-up was not until September 1972, which is outside the period under evaluation in this report.

5.1.5 Central Facilities Area (CFA)

ATTRIBUTION: Section 5.1.5 was completed by Mitch Findley, MJW Corporation. All conclusions drawn from the data regarding the Central Facilities Area were peer-reviewed by the individuals listed on the cover page. The rationale for all conclusions in subsequent sections of this document that are devoted to the Central Facilities Area are explained in the associated text.

Beginning in 1950, the Naval Base used during World War II as a site for testing guns reconditioned at the Naval Ordnance Plant in Pocatello, Idaho was converted to the Central Facilities Area (CFA). The old housing units were converted into offices that were used by the AEC and various AEC contractors. CFA served as the primary service and support center for INL programs (Stacy, 2000). While there were many centralized functions at CFA, there were few buildings and areas within CFA with any radioactive material hazards associated with them. Figure 5-41 shows the CFA in 1961 with buildings of interest designated.

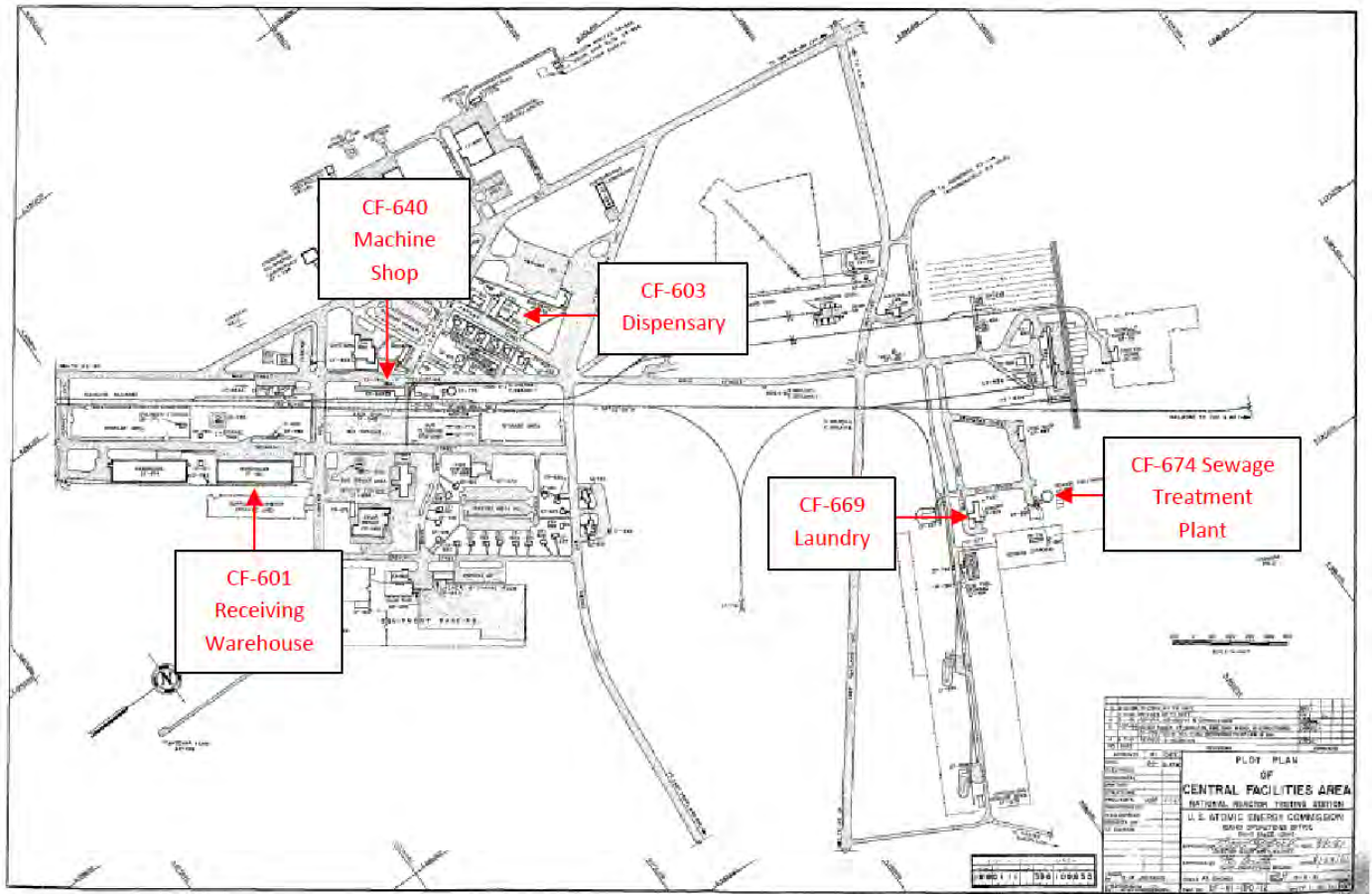

Figure 5-41: Map of the Central Facilities Area in 1961 with Buildings of Interest

The following CFA buildings had hazards associated with them:

- CF-610 and CF-616: Headquarters of the Idaho Nuclear Corporation's Health and Safety Branch Manager, Industrial Safety Director, their staffs, and the CFA Health Physics Group, which was responsible for the CFA and certain associated areas. The radiation exposure records for all employees and visitors were maintained in this building.
- CF-616: Headquarters of the INL respiratory protection and equipment program.
- CF-669: The Central Facilities Laundry (constructed in 1950) laundered contaminated clothing or protective clothing that was used in radioactive areas. Laundry services included washing, drying, pressing, folding, and repairing of protective clothing. Because of the risk of possible contamination, no other items were washed at this laundry; non-contaminated clothing was sent to a commercial laundry. Clothing being sent to the CFA Laundry was segregated as to type (shoe covers, coveralls, gloves, etc.) and contamination level. After it was laundered and dried, the clothing was monitored for contamination on special tables. Each general type of clothing had its own permissible contamination limits. Any item that exceeded the recommended permissible limits was rewashed. After a defined decay period, Anti-C clothing that could not be decontaminated below those levels was bagged, labeled, and returned to the plant for disposal or

use as determined by area health physicists. The laundry had a radiation detector above the receiving room door and a continuous air monitor (CAM) in the working area. The CFA laundry was also used as an Anti-C change room and personnel decontamination facility for CFA personnel.

- CF-674: The Sewage Treatment Plant, located near the laundry, processed any radioactive material placed in a drain at CFA. Most of the radioactive waste came from the Laundry (CF-669), although small amounts entered from CF-656 and CF-690. A hazardous area was created at the drying pond into which sewage was dumped. The dried sludge or sewage was removed periodically and shipped to the Burial Ground as a routine radioactive shipment.
- CF-640 and CF-665: The Machine Shop and the Maintenance Shop may have had radioactive material in them from time-to-time. Radioactive material that the plant shops could not handle was worked on in the more fully-equipped CFA Machine Shop. Usually this material was of a low radiation and contamination level. The Maintenance Shop personnel would sometimes work on vehicles and equipment that were used to haul radioactive material. Such vehicles were surveyed prior to shop maintenance work and, when necessary, sent to CPP for decontamination.
- CF-674A: The Chemical Engineering Laboratory was located at the south end of the CF-674 Warehouse. Experiments involving radioactive tracers were prepared here; the resulting data was used for processing design at CPP.
- CF-601: The CF Warehouse was the receiving center for radioactive shipments received via commercial carriers during regular working days. These shipments were monitored by CF Health Physics and the proper papers were completed and routed to the proper recipients (Savignac, 1961).

The following buildings usually did not have hazards associated with them but are presented and described because of their importance to CF health physicists.

- Powder Bunkers: The powder bunkers were used as a temporary storage area for small lots of radioactive material sent to INL for burial.
- Gantry – Rail Yard Area: All incoming or outgoing radioactive rail shipments, including piggyback trailer trucks, were routed through this area (see Figure 5-42).



Figure 5-42: ETR Reactor Vessel Arriving at CFA Gantry Crane in 1956

- CF-603: The CF Dispensary provided major medical services. The dispensary was completely staffed and equipped to offer NRTS contractors services ranging from physical examinations to evaluation and treatment of occupational injuries or minor non-occupational illnesses. The CFA dispensary also served as a bioassay sample collection station. In addition, a thyroid counter was located there.
- CF-690: AEC Health and Safety Technical Services included the External Dosimetry Branch, Analytical Chemistry Branch, Health Physics Branch, Instrumentation Branch, and Waste Management Branch. The Radiological and Environmental Sciences Laboratory provided radiobioassay and dosimetry services to INL until 1988.

Associated Areas of CFA responsibility included:

- Burial Ground: Operational and health physics responsibility
- ARA Hot Cells: Health physics responsibility after 1965
- Site Vehicle Survey: Radiological survey of approximately 900 vehicles plus NRTS buses at set frequencies or as needed

5.1.6 Burial Ground

ATTRIBUTION: Section 5.1.6 was completed by Mitch Findley, MJW Corporation. All conclusions drawn from the data regarding the Burial Ground were peer-reviewed by the individuals listed on the cover page. The rationale for all conclusions in subsequent sections of this document that are devoted to the Burial Ground are explained in the associated text.

The AEC recognized the need to have a local disposal ground for the solid radioactive waste generated during INL operations. In 1949-50, the U.S. Geological Survey (USGS) conducted extensive environmental monitoring in search of an appropriate burial site. In 1951, the site was selected due to the geology and hydrology characteristics of the land (see Figure 5-43). In May 1952, the first 13 acres were fenced in for shallow disposal of solid low-level waste. On July 3, 1952, the first trench was opened for the disposal of mixed-fission product (MFP) waste (see Figure 5-44) (RWMC History, 1979). Operation of the Burial Ground (also known as the Subsurface Disposal Area) was the responsibility of the Site Survey Branch of the AEC with waste disposal under the supervision of a health physicist of the Site Survey Branch.



Figure 5-43: Road to the Burial Ground in 1961

Between 1952 and 1957, Trenches 1-10 were excavated. Metal tags on the fence enclosure marked trench locations. From the inception of the Burial Ground, it was policy to have a health physicist present to dump waste (RWMC History, 1985).

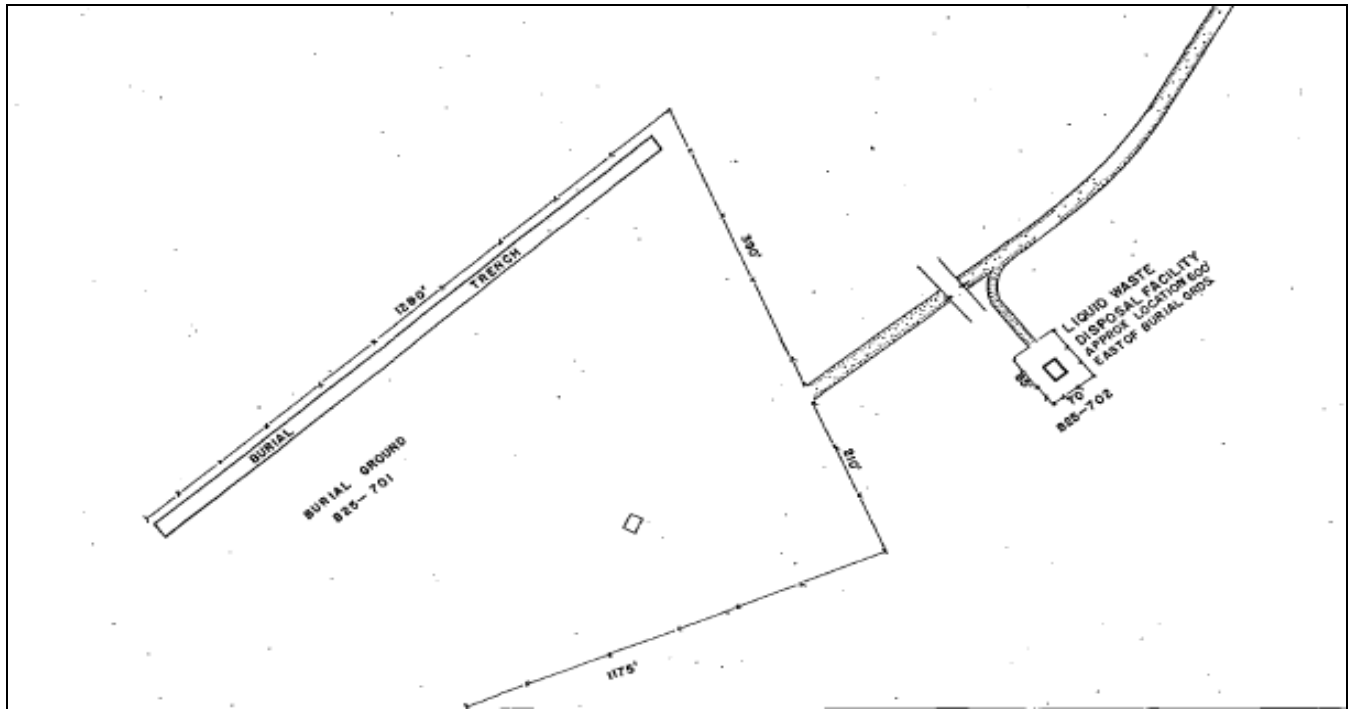

Figure 5-44: Burial Ground, circa 1955

On April 22, 1954, the Burial Ground received the first shipment of transuranic (TRU) waste from Rocky Flats. These shipments were to last until 1971, with Rocky Flats being the dominant contributor of TRU waste. Between April 1954 and November 1957, Rocky Flats TRU-contaminated waste was mixed with INL MPF-contaminated waste in Trenches 1 through 10. Rocky Flats waste arrived in the CFA by railcar where it was transferred to a flatbed truck and taken to the Burial Ground. The 55-gallon drums of Rocky Flats TRU waste were hand-stacked until 1963. Heavy items were emplaced with cranes. Normal operating practice was to include classified waste containers with other waste containers in the same trailer load. Shipments did not contain papers describing physical form and radionuclide content until 1964. Rocky Flats provided a memo at end of each year with a summary of the total radionuclide content and volume shipped to INL (RWMC History, 1979).

In 1957, the Burial Ground was expanded from its initial 13 acres to 88 acres. At that time, a routine twice-weekly pick-up of site-generated waste was initiated. The year 1957 also marked the excavation of the first burial pits for the receipt of bulky items from Rocky Flats as well as the transition of burial of Rocky Flats waste drums from trenches to pits (see Figure 5-45) (Remediation, 2006).



Figure 5-45: Emplacement of Rocky Flats Drums in a Burial Ground Pit in 1958

In May 1960, the AEC designated the INL Burial Ground, and one at ORNL, as interim burial grounds for waste from other AEC sites as well as non-AEC waste generators. As a result of the AEC's decision, large quantities of beta-gamma-contaminated waste were received from private industry, universities, the U.S. Armed Forces, and AEC contractors. INL and ORNL established formal policies and procedures for dealing with improper or problem shipments. On May 21, 1961, a separate burial ground opened near SL-1. The burial ground included one trench and two pits for contaminated materials from the January 3, 1961 SL-1 accident so that waste would not have to be transported over 16 miles away to the Burial Ground (RWMC History, 1985).

On October 1, 1962, the responsibility for managing and operating the Burial Ground was transferred from the Site Survey Branch of the AEC to Phillips Petroleum Company, which had been acting as AEC's agent in operating the Burial Ground (RWMC History, 1985). In June 1963, the AEC announced its decision to withdraw its services as an interim burial ground for radioactive waste effective August 12, 1963. The decision was made because other suitable burial sites had been established by private industry. Rocky Flats waste was still received at INL because privately-operated burial grounds were not allowed to receive classified or sensitive waste. In November 1963, a decision was made to no longer stack Rocky Flats waste, but rather, to dump the drums into the burial pits to reduce labor costs and minimize personnel external exposures (see Figure 5-46). This practice lasted until late 1969 (RWMC History, 1979).



Figure 5-46: Mass Dumping of Rocky Flats TRU Drums in 1969

Beginning in April 1964, waste shipments from Rocky Flats were declassified and no classified materials were to be included in future shipments to the INL Burial Ground. Also, around that time, the first shipments of waste from the Coors Porcelain Company (via Rocky Flats) began arriving at INL. These shipments consisted of thirty 55-gallon drums of low-level contaminated waste from the Pluto Program that were generated between 1964 and 1970 (RFP Waste, 2005).

In January 1969, after two days of rainfall and thawing ground, water runoff filled Pit 10 and much of Trenches 48 and 49 (see Figure 5-47). Snowdrifts blocked the existing drainage that was installed after the 1962 “Chinook” flood. The runoff topped old dikes and flowed through the Burial Ground causing heaving of buried waste. Later, the dikes would be raised and the exterior drainage ditches enlarged so heavy equipment could clear snowdrifts. A major fire at Rocky Flats in Building 776 on May 11, 1969 was the initiating event for major changes to come for the Burial Ground. The two-year clean-up from the fire dramatically increased waste shipments to INL and caused Idaho Senator Frank Church to request four federal agencies, including the Bureau of Radiological Health, to conduct a joint review of the Burial Ground. As a result, the AEC recommended suspension of the burial of intermediate-level waste from Rocky Flats during the winter. It was also noted that experience at other facilities suggested that segregation of plutonium-contaminated waste was advisable (RWMC History, 1985).



Figure 5-47: January 1969 Flooding of Burial Ground

In late 1969, there was a retrieval effort in Pit 1 for some experimental equipment that was believed to have been inadvertently buried. It marked the first time in the history of the Burial Ground that waste was deliberately exhumed; it foreshadowed future remediation work that is now the primary focus of work currently performed at the facility (RWMC History, 1985).

During 1970, several actions resulted in discontinuing burial of plutonium-contaminated waste at INL. In January, a directive from the AEC-ID Manager stopped burial of Rocky Flats waste at the Burial Ground during winter and spring, and required that Rocky Flats waste be stacked above ground. On March 20, 1970, the AEC issued Immediate Action Directive No. 0511-21 requiring segregation of all waste contaminated with long-lived TRU waste > 10 nCi/g. In October 1970, the construction of Transuranic Storage Area-1 (TSA, aka Idaho Transuranic Storage Area) was completed and the first waste was stored on TSA-1 on November 9, 1970. In 1971, the first buildings were installed at the Burial Ground, consisting of a trailer for Burial Ground operations and Health Physics, and a TSA clothing-change trailer. The installation of these trailers is outside the period under evaluation for this evaluation for this report (Remediation, 2006).

Figure 5-48 shows a schematic of a Transuranic Storage Area. Figure 5-49 shows a current map of the Burial Ground and other facilities associated with the Radioactive Waste Management Complex.

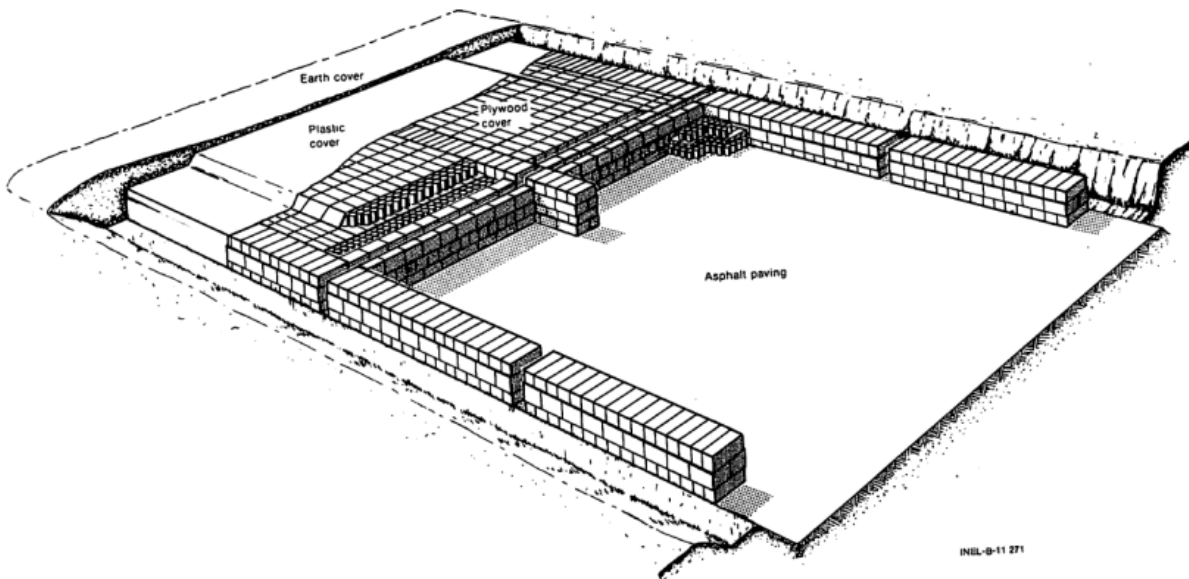

Figure 5-48: Schematic of a Transuranic Storage Area

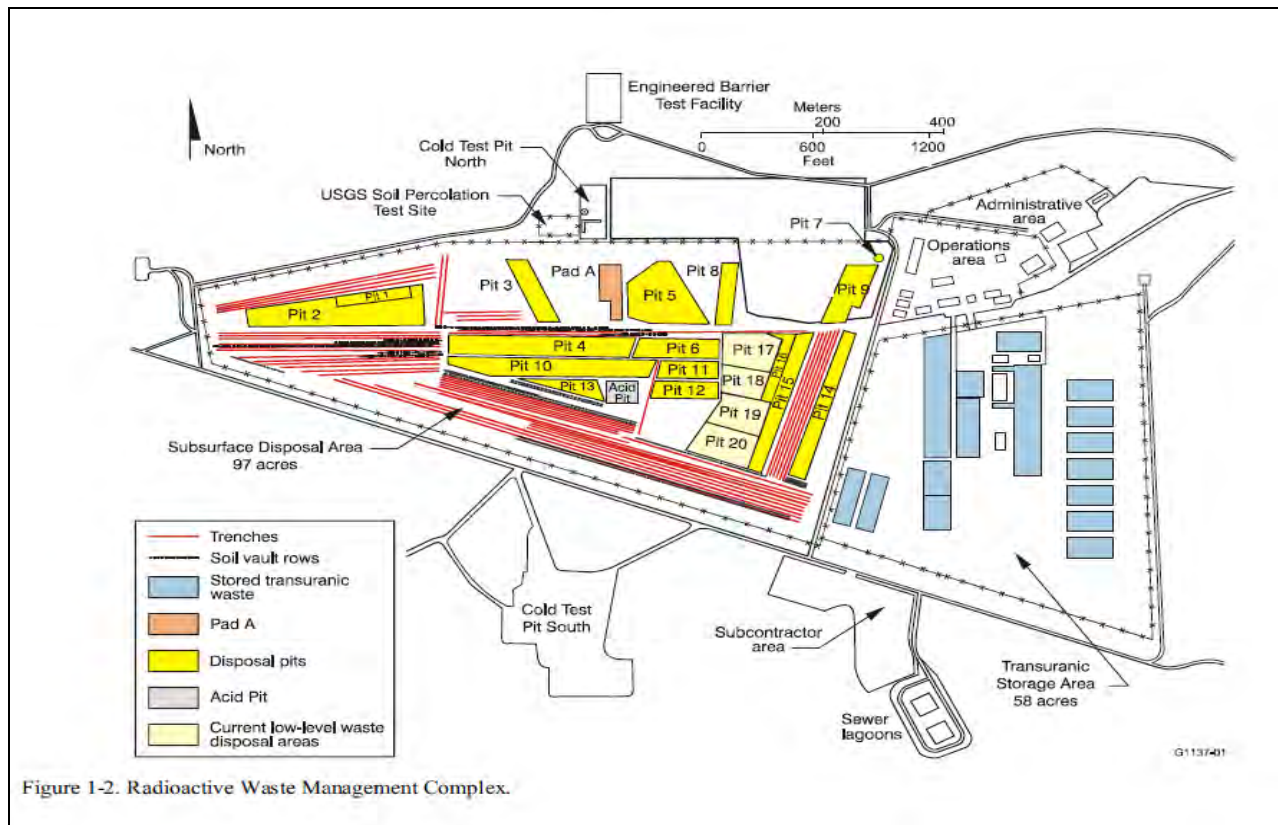

Figure 5-49: Current Map of the Burial Ground and Associated Facilities

5.2 Internal Radiological Exposure Sources from INL Operations

Radionuclides with the widest application throughout INL facilities during the period under evaluation are:

- Fission and activation products (e.g., Sr-90, Cs-137, Zn-65, Co-60)
- Exotic radionuclides (e.g., C-14, Ca-45, P-32, S-35, Ba-140/La-140, and others produced by reactor neutron irradiation, including transuranic radionuclides)
- Plutonium (Pu-238, Pu-239, Pu-240, Pu-241)
- Uranium (U-238, U-233, U-234, U-235, U-236)
- Thorium (Th-232)

The following subsections provide an overview of the internal exposure sources specific to the six operating areas for the INL class under evaluation.

- Test Reactor Area (TRA) – Section 5.2.1
- Chemical Processing Plant (CPP) – Section 5.2.2
- Test Area North (TAN) – Section 5.2.3
- Misc. Reactor Areas (SPERT, ARA, GCRE, OMRE) – Section 5.2.4
- Central Facilities Area (CFA) – Section 5.2.5
- Burial Ground – Section 5.2.6

5.2.1 Internal Radiological Exposure Sources from Test Reactor Area Operations

The diversity of operations at the Test Reactor Area makes it difficult for NIOSH to collect complete details of all TRA internal exposure sources. Nevertheless, NIOSH has determined that the internal dose potential during the period under evaluation is associated with reactors, laboratories, machine shops, and other research and support activities as well as radioactive waste disposal. Although not all specific areas where waste materials were generated and buried are readily identifiable from the documents available to NIOSH, a potential for internal intakes from these activities is assumed to exist. The following radionuclides specific to TRA operations are discussed in the subsections below and in Section 7.2.:

- Fission and activation products (e.g., Sr-90, Cs-137, Zn-65, Co-60)
- Exotic radionuclides (e.g., C-14, Ca-45, P-32, S-35, Ba-140/La-140, and others produced by reactor neutron irradiation, including transuranic radionuclides)
- Plutonium (Pu-238, Pu-239, Pu-240, Pu-241)
- Uranium (U-238, U-233, U-234, U-235, U-236)
- Thorium (Th-232 and Th-228/Th-230)

5.2.1.1 Fission and Activation Products

Since the inception of the MTR in 1952, fission and activation product exposure potential has existed at TRA. This exposure potential continues to the present because the ATR is still in operation. Thus, potential exposure to fission and activation products existed throughout the period under evaluation (1949-1970), as indicated in surveys, air samples, and bioassay samples for fission and activation products (via gross alpha and gross beta/gamma analysis) (INEL Bioassay, 2010a; INEL Bioassay, 2010b).

5.2.1.2 Exotic Radionuclides

TRA reactors used neutron irradiation to generate radionuclides beyond the spectra of fission and activation products (e.g., C-14, Ca-45, P-32, Ba-140/La-140, and others). NIOSH has used documentation, data, and shipping receipts for these operations to develop a list of radionuclides handled at TRA during the period under evaluation. NIOSH has not captured shipping reports for some years, so this list is not considered a complete inventory. The list includes fission products, activation products, and actinides, including transuranics.

Experiments (and their resulting radionuclides) were transferred to and from the reactors using the sample rabbits, pneumatic transfer tubes, and discharge chutes mentioned in Section 5.1.1 as well as other shielded apparatus. Some testing of experiments was conducted directly from fuel bins while other testing was performed in reactor canals. After some cooling in reactor canals, some experiments were repackaged directly to shipping casks and returned to the project requestor. Samples were taken from some experiments after transfer by pneumatic tubes to either hot cells or the alpha cave. Those samples were transferred to either the Fast Chopper for cross-sectional analysis or to one of the labs at TRA or CPP via a specially-designed, shielded carrier. NIOSH has not found documentation to show that TRA personnel handled irradiated or highly-radioactive samples in open lab environments. NIOSH has captured documentation of incidents involving loss of containment of radioactive materials. Such incidents are discussed in Section 5.4.1.

Small amounts of tritium were generated through research that entailed highly irradiating beryllium, once in 1960 and once in 1961. Gases produced by the irradiations were analyzed in a vacuum system housed in a fume hood that was originally in the lab area and then moved to one of the alpha labs in 1961 (Mahathy, 2015). The beryllium gas was melted and handled in the vacuum system with helium, hydrogen, and tritium components separated by a palladium trap. The measured yield of tritium gas inside the vacuum system ranged from 2.7 to about five percent of the gas (Mahathy, 2015).

5.2.1.3 Plutonium

Potential for plutonium exposure existed at TRA during the entire period under evaluation, and at each of the primary reactors (MTR, ETR and ATR). Plutonium fuel cores were used twice at MTR, for one cycle in 1958 and for about five months in 1970. The latter fuel core was disassembled at the ARA Hot Cell in December 1970 (Mandiloff, 1971). Plutonium fuel plates and assemblies received from other sites, including Hanford, ORNL, and University of California Radiation Lab were irradiated at MTR through much of its operating history. After irradiation, these materials, sometimes cooled in the MTR canal and with some analyses, were returned to the originator. Examples of plutonium

materials shipped back post-irradiation are: (1) One irradiated plutonium-aluminum alloy "napkin-ring" shipped to Argonne National Lab in January 1954 (MTR Progress Report, 1953); (2) plutonium in metallic form shipped to Lawrence Radiation Lab in October 1962 (Bengstad, 1962, PDF p. 17); and (3) plutonium in metallic form shipped to Lawrence Radiation Lab in May 1963 (McKenna, 1963, PDF p. 19).

TRA work involving plutonium is supported by the existence of routine bioassay as well as incident/air sample-based plutonium bioassay data for TRA workers. With the exception of work performed in the Alpha Labs for which incident-based plutonium bioassay data are available, all other potential plutonium exposures would have included concurrent exposure to mixed fission products for which there was routine bioassay.

5.2.1.4 Uranium

The potential for uranium exposure existed at TRA during the entire period under evaluation but the potential was very small because TRA received encapsulated materials, irradiated them, and either stored them as spent fuel or returned them to the CPP - without opening the capsules. On some occasions, MTR lab staff analyzed samples made of U-233 in hot cells. The MTR metallurgical lab also fabricated test fuel capsules using depleted and enriched uranium. Uranium would include U-238, U-233, U-234, U-235, and U-236.

5.2.1.5 Thorium

The potential for thorium exposure existed at TRA during the entire period under evaluation. Many irradiations were performed using encapsulated materials to test the nuclear and physical properties of thorium for use as a fuel. Samples of such irradiated thorium were collected in the reactor and canal but transferred in shielded rabbits using pneumatic tubes. Some thorium was irradiated to make U-233 and Pa-233. In both cases, the end products were transferred and handled in shielded containment. Figure 5-21 shows a worker preparing pure Pa-233 from irradiated thorium.

5.2.2 Internal Radiological Exposure Sources from CPP Operations

The primary function of the Chemical Processing Plant was to process spent fuel elements containing enriched uranium for the recovery of the un-fissioned uranium. Fuel elements were dissolved in acid and the uranium was separated from fission products by continuous liquid-liquid extraction, employing tributyl-phosphate (TBP) and methyl iso-butyl ketone (MIBK) as solvents (Analytical Lab, 1957).

Much of the processing equipment in the process building was located in heavily-shielded cells and had to be operated remotely, reducing the chances for an internal radiological exposure. However, the entire plant design was based on a direct-contact maintenance philosophy (i.e., maintenance was performed by direct manual contact only during periodic shutdowns and then only after the particular cell and equipment were thoroughly decontaminated) (CPP Safety Review, 1974). In addition, during processing, samples were taken of the dissolver solution, the raffinates from all three cycle extraction columns, and the final product solution (Analytical Program, 1957).

Radionuclides with the widest application throughout CPP facilities during the period under evaluation are listed below. They are discussed in the following subsections and in Section 7.2.

- Uranium
- Neptunium
- Plutonium
- Fission and Activation Products
- Barium/Lanthanum
- Thorium
- Radioactive Noble Gases
- Iodine
- Tritium

NOTE: When radioactive noble gases are released into the atmosphere, external exposures dominate. Whole-body doses resulting from immersion in rare gases are usually calculated by considering only external irradiation. The results ignore any contributions to dose resulting from the absorption of inhaled gas in the blood and its subsequent diffusion into other tissues. However, radioactive noble gases are not entirely insoluble in body fluids. Hence, for a person immersed in a cloud of noble gas, the whole-body dose from the gas absorbed by the body tissues following inhalation should be considered in addition to the dose from the radiation external to the body.

Radiation doses resulting from the inhalation of noble gases can be estimated using the dose conversion factors shown in Table 5-6, where all values are in units of mrem per one minute of submersion in a concentration of 1 $\mu\text{Ci/g}$ (air):

Table 5-6: Dose Conversion Factors for Kr-85 and Xe-133		
Organ	Radionuclide	
	Kr-85	Xe-133
Tracheal Mucosa	0.086	0.116
Lung	0.032	0.020
Fatty Tissues	0.005	0.011
Lean Tissues	0.0006	0.0019
Gonads	0.0006	0.0012

This same krypton concentration and exposure time would produce a total external dose of 3.847 mrem to the skin.

Because radioactive noble gases do not represent a significant internal exposure concern for INL, NIOSH finds there is no need to assess the internal doses attributable to radioactive noble gases.

5.2.2.1 Uranium

The function of the Idaho Chemical Processing Plant was to process fuel elements containing uranium enriched in U- 235 for recovery of the un-fissioned uranium. The uranium isotopes in feed samples were U-234, U-235, U-236, and U-238. Routine samples were taken of the dissolver solution, the

aqueous raffinates from all three cycle extraction columns, and the final uranyl nitrate product. The high concentration of fission products in the dissolver solution and first-cycle extraction raffinate required the use of remote-handling facilities for separation and analysis. In addition, the high activity of the raffinates required that samples be limited to 1 mL or less. Uranium sampled from column raffinates usually contained 1×10^{-3} mg uranium per mL of sample (Analytical Program, 1957).

In 1957, two thorium slugs that had been irradiated in the MTR were dissolved and analyzed for total U-233. Each slug had a total mass of 1730 g, with 78 grams being aluminum cladding. Separation of the uranium was performed in a glove box and small samples were transferred to the Mass Lab for analysis (Uranium, 1957). In addition, U-233 was used as a spike isotope in the analytical laboratories (Analytical Program, 1957).

U-233 and U-232 are formed by the following series of reactions:

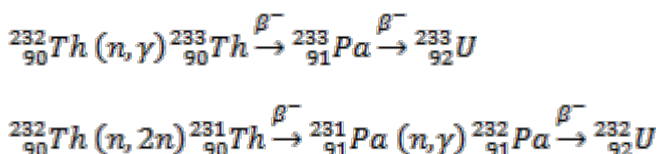

5.2.2.2 Neptunium

Neptunium-237, an alpha-emitting radionuclide with a half-life of 2.1 million years, tends to concentrate on the bone surfaces when inhaled or ingested. The isotope is produced in uranium-fueled reactors by one of the two following reactions:

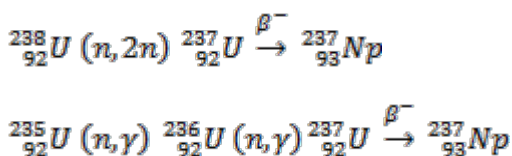

Which of the two reactions dominates the process depends on the degree of fuel enrichment. In natural uranium, approximately 70% of the neptunium is produced by the first reaction, and the remainder is produced by the second (Neptunium, 1972). The highly-enriched fuels processed at CPP would have seen neptunium produced primarily through the second reaction (Uranium, 1966).

In 1958, the CPP Technical Division requested the development of a method for determining neptunium in process-stream samples. Analytical work done in support of this request was carried out in the Remote Analytical Facility, along with work investigating the possibility of recovering Np-237 from process raffinates (CPP Progress Report, Jan1958). A satisfactory method for determining the concentration of neptunium in process streams was documented in February, 1958 (CPP Progress Report, Feb1958). A simplified process was recorded in July 1958 (CPP Progress Report, Jul1958), and routine analysis of plant process streams for Np-237 concentrations began in August 1958 (CPP Progress Report, Aug1958). Due to operational difficulties in other plant processes, the test program to concentrate neptunium from plant streams was abandoned in September 1958 (CPP Progress Report, Sep1958). A second, short-lived pilot program was initiated in May 1959 and continued for a few months (CPP Progress Report, Jun1959).

Because of the differing chemistry between uranium and neptunium, most of the neptunium in the reactor fuels processed prior to 1965 was lost to first-cycle raffinate. The feasibility of recovering Np-237 from reactor fuels at CPP was demonstrated during a 1964 aluminum-alloyed fuel-processing run by recovering over 90 percent of the neptunium in the second-cycle raffinate generated during the campaign (i.e., 18.8 g of the estimated 32 g available) (Uranium, 1966). Following these preliminary demonstration tests, routine recovery of Np-237 at CPP began in 1965. In the separation scheme, Np(VI) was co-extracted with uranium and some plutonium into the first-cycle 5% TBP solvent. Neptunium and plutonium accompanied the uranium through the first-cycle scrubbing and stripping columns. Partitioning of uranium from neptunium and plutonium was then effected in the second-cycle acid-deficient hexone-extraction column by addition of ferrous sulfamate to reject neptunium and plutonium to the raffinate stream.

The accumulated raffinate stream was then processed in a separate operation for neptunium recovery and concentration by evaporation. The concentrated neptunium product obtained at this point was essentially free from fission products but still contained plutonium and some uranium (Neptunium, 1972). In January 1969, the accumulated solution (containing 1.9 kg of Np-237) was sampled in J cell and further concentrated to about 250 L before being stored in a vessel in Cell N as an impure nitric acid solution (Neptunium, 1969).

In total, these raffinate streams were collected over a seven-year period. Final processing of the Np-Pu-U solution was successfully completed during a three-week campaign in June 1972. The uranium was partitioned from the neptunium and plutonium, then the neptunium and plutonium solution was decontaminated from fission products. The final solution, containing 5412 g of neptunium and 544 g of plutonium, was shipped off-site for eventual neptunium purification (Neptunium, 1973).

5.2.2.3 Plutonium

Plutonium would include Pu-238, Pu-239, Pu-240, and Pu-241. On a mass basis, Pu-239 is usually the most prevalent isotope of plutonium in spent nuclear fuels. However, because of the relatively-short half-life of Pu-238 (88 years) in most fuels, more than 90% of the plutonium activity is due to the presence of Pu-238. Most of the fission products were extracted from the process solution into the 1A raffinate stream. The plutonium activity may or may not have followed the fission products, depending upon the nature of the fuel. In general, the Pu-238 activity became the dominant radiological hazard once the process made it past the 1A column. The first-cycle product was highly concentrated and presented a significant plutonium hazard, which was decontaminated from fission products.

Plutonium continued to dominate the potential internal radiological hazards throughout the second and third process cycles until the product proceeded beyond the 3AR stream. At that point, the U-234 activity became the dominant hazard (CPP Dosimetry, 1984).

Highly-enriched U-235 fuels were processed at the CPP to recover residual U-235. Because initial processing rates were low, the plant was designed using essentially pilot-plant principles, and maintenance was designed to be performed by cell entry and contact techniques. Due to the relatively-low U-238 content in the fuel, plutonium was judged not to be a problem. However, in the course of operation, the burn-up of fuels increased; and in some fuels, the U-238 content was higher

than originally expected. This led to questions about whether plutonium might be a current problem, or might become a problem with predicted higher burn-ups (Plutonium, 1980).

For most of the CPP operating period, plutonium was regarded as an undesirable contaminant to the final uranium product. In 1954, a sample was taken from the final product solution and analyzed for plutonium contamination and found to contain less than 1 part-per-billion plutonium (CPP Progress Report, Feb1954). In November 1957, CPP Engineering Design Section was requested to prepare plans and a cost estimate for the conversion of X-Cell into a radiochemical development area capable of handling plutonium (CPP Progress Report, Nov1957). In January 1958, MTR Technical requested the analysis of four fuel elements from the MTR 20%-enriched-uranium fuel core. However, due to the lack of adequate plutonium-handling facilities, a complete analysis could not be made at the CPP (CPP Progress Report, Feb1958). As a workaround, the dissolution of the elements occurred in L-Cell, radiochemical separation was conducted in the Remote Analytical Facility, and mass analysis was conducted at Argonne (CPP Progress Report, Feb1958).

Although plutonium would have been present in the process and waste streams, NIOSH has found no indication that partitive equipment was ever added to the plant that would allow the plutonium to be separated from the waste stream (Stroschein, 1967; CPP Phase-out, 1994).

5.2.2.4 Fission and Activation Products

Fission and activation products present in spent fuel include Sr-90, Cs-137, Zn-65, Co-60 and numerous others. Over 99 percent of the fission products present in the spent fuel would exit the process in the first-cycle extraction raffinates. Dissolver solutions passed through several cycles of countercurrent solvent extraction to remove essentially all fission products and transuranic elements from the final product uranium solution. Prior to construction of the WCF, these wastes were segregated by fuel types and stored in either 30,000-gallon tanks designated for zirconium- and stainless-steel-clad fuel wastes, or 300,000-gallon tanks designated for aluminum-clad fuels. These wastes were packaged into 500-gallon lead-shielded spheres and shipped to the ORNL fission product recovery facility (CPP Waste Management, 1960).

Other liquid wastes from process-equipment drains, cell-floor drains and decontamination-area drains, amounting to a million gallons per year, were collected in tanks before transfer to the process equipment waste evaporator for concentration. Table 5-7 presents a summary of the estimated high-level liquid radioactive waste volumes and the associated activity for fiscal years 1972 through 1975. Between December 1963 and May 1974, over 2.7 million gallons of liquid wastes containing 45.8×10^6 Ci of fission products and transuranics were sent to the WCF.

Table 5-7: Fiscal Year-End Inventories of Radioactive Liquid Waste Activities		
Year	Nuclide	Activity (Ci)
1972	All*	20 X 10 ⁶
	Sr-90	3 X 10 ⁶
	Cs-137	4 X 10 ⁶
1973	All	53 X 10 ⁶
	Sr-90	6 X 10 ⁶
	Cs-137	7 X 10 ⁶
1974	All	78 X 10 ⁶
	Sr-90	6 X 10 ⁶
	Cs-137	7 X 10 ⁶
1975	All	90 X 10 ⁶
	Sr-90	9 X 10 ⁶
	Cs-137	9 X 10 ⁶

Source: Waste Management, 1974

* "All" radionuclides includes fission products as well as transuranics.

Table 5-8 presents a summary of the estimated calcined solid waste volumes and the associated activity for fiscal years 1970 through 1975.

Table 5-8: Fiscal Year-End Inventories of Calcined Solid Waste Activities		
Year	Nuclide	Activity (Ci)
1970	All	3.3 X 10 ⁷
	Sr-90	7.1 X 10 ⁶
	Cs-137	8.3 X 10 ⁶
1971	All	3.4 X 10 ⁷
	Sr-90	7.8 X 10 ⁶
	Cs-137	9.0 X 10 ⁶
1972	All	4.1 X 10 ⁷
	Sr-90	9.1 X 10 ⁶
	Cs-137	10.5 X 10 ⁶
1973	All	4.8 X 10 ⁷
	Sr-90	10.1 X 10 ⁶
	Cs-137	11.6 X 10 ⁶
1974	All	5.0 X 10 ⁷
	Sr-90	10.5 X 10 ⁶
	Cs-137	12.0 X 10 ⁶
1975	All	6.8 X 10 ⁷
	Sr-90	14.3 X 10 ⁶
	Cs-137	16.2 X 10 ⁶

Source: Waste Management, 1974

5.2.2.5 Barium/Lanthanum

While most of the plant was concerned with the recovery of uranium from spent fuel and fission products, the RaLa process was concerned with the recovery of a fission product. RaLa stands for radioactive lanthanum, a fission product valued for its high-energy gamma radiation.

In the RaLa process, a fresh fuel element just out of the MTR was dissolved in caustic, and Ba-140 extracted by a series of precipitations and re-dissolutions. Barium-140 was then allowed to decay to La-140 which then could be separated and used (Stroschein, 1967).

5.2.2.6 Thorium

In 1957, two thorium slugs that had been irradiated in the MTR were dissolved and analyzed for total U-233. Each slug had a total mass of 1730 g, with 78 grams being aluminum cladding. Separation of the uranium was performed in a glove box and small samples were transferred to the Mass Lab for analysis (Uranium, 1957).

In 1961, the Analytical Section was requested by the Reactor Physics Research Group to analyze six irradiated thorium slugs for uranium concentration and isotope ratio, aluminum, thorium, Cs-137, and Zr-95. Each of the six slugs had a mass of about 1730 g and were dissolved and prepared for analysis in the Multicurie Cell. Manipulations within the cell were made with a pair of master-slave manipulators (Thorium, 1961).

5.2.2.7 Radioactive Noble Gases

The Rare Gas Plant was operated at CPP to recover krypton and xenon from gases released during the dissolution of reactor fuels. The plant was designed to recover several thousand curies per day of krypton and a significant volume of xenon from off-gas evolving from the acid dissolution of spent nuclear reactor fuel elements. Radioactive isotopes of interest liberated during dissolution are presented in Table 5-9. The original process used charcoal absorbers (operating at liquid nitrogen temperatures) for removing radioactive krypton from the dissolver off-gas. When the absorbent was saturated, it was heated to drive off the rare gases which were then collected in a cold trap. However, the product from this early process was impure, and the cooling requirements of the process required more nitrogen than the existing liquid nitrogen plant could produce on a continuous basis (Offutt, 1969).

Isotope	Half-life	Emission
Kr-85	10.76 years	0.687 MeV β^-
Xe-133	5.243 days	0.427 MeV β^-
Xe-135	9.14 hours	1.165 MeV β^-

Initially, the plant only operated during the dissolution of aluminum-alloyed fuels due to concerns about the combustion potential of the hydrogen-rich off-gas from other fuel types (CPP Krypton, 1979). The plant was not upgraded to allow processing of hydrogen-rich off-gas streams until 1987.

As discussed in the introduction to Section 5.2.2, because radioactive noble gases do not represent a significant internal exposure concern, NIOSH finds there is no need to assess the internal doses attributable to radioactive noble gases.

5.2.2.8 Iodine

The initial operating theory at CPP was that fuels processed were cooled sufficiently that radioiodines and short-lived noble gases should have decayed to insignificant levels (Waste Management, 1974). However, during December 1956, 495 fuel elements were dissolved at CPP with 175 of those elements having been discharged on September 11, 1956, and the remaining 420 elements having been discharged on September 29, 1956. This led to the release of I-131 quantities shown in Table 5-10.

Table 5-10: I-131 Release from C Cell Dissolving Operations During December 1956	
Dates	Curies of I-131
December 1-10	0
December 11-12	7.2
December 13	0
December 14-15	35.5
December 16-19	59.7
December 20-31	0

Because of a cooling time of only two days, compared to the 90-120 days cooling normally provided for most other fuel elements before reprocessing, the RaLa process contributes large quantities of fission product iodine to the process off-gas. Each fuel element used in this process contained approximately 200 grams of uranium when charged into the reactor. Processing of the fuel was accompanied by release of approximately 25,000 curies of I-131, which needed to be trapped and confined (CPP RaLa, 1969). Most of the iodine found in the vessel off-gas system was released during solution transfers, particularly transfer of the process wastes to storage. The use of compressed air to inject reagent solution into the centrifuge bowl, and the consequent escape of iodine-contaminated gases from the centrifuge shaft seal, was the major cause of iodine release to the cell atmosphere and ventilation system (I-131 Containment, 1961).

The virtually complete containment of iodine was a major objective in the design of the RaLa process. The RaLa system was designed for a vacuum of 10 to 20 inches of water in all process equipment to ensure that any leakage would be from the cell atmosphere into the equipment. All the process off-gas, plus any air leakage into the system, was to be passed through an iodine-removal scrubber before release to the atmosphere through the 250-foot plant stack. However, the first processing of a fully-irradiated fuel element disclosed serious deficiencies in the iodine-containment measures. The peak iodine release rate to the process off-gas was considerably higher than had been anticipated. The

transfer of the dissolution supernate waste solution through the plant lines and vessels to permanent storage released about 200 curies of I-131 to the main CPP vessel off-gas system.

An upgraded RaLa Off-Gas system contained charcoal beds for removing radioiodine and a gas holder for storing the noble gases during decay (Waste Management, 1974). This system was able to remove gaseous iodine with a 99.9% efficiency, but was still limited in its ability to remove iodine-bearing dusts and mists (I-131 Containment, 1961).

5.2.2.9 Tritium

From 1953 (when CPP operations began) to 1984, CPP wastewater containing tritium was routinely injected into the Snake River Plain aquifer through a 580-ft-deep disposal well. Beginning February 9, 1984, the wastewater was routinely sent to an infiltration pond; a second pond was put into use on October 17, 1985. The disposal well was used as an emergency back-up to the disposal ponds from 1984 to 1986.

During the 1971 zirconium-processing campaign, several streams in the first-cycle uranium extraction system were sampled and analyzed for tritium. The results from five different sample sets were averaged and a tritium material balance was made using the tritium entering the system in the IFU stream as the base value. The fraction of tritium in the IBR, ICR, and ICP streams was found to be very small. The ICR organic stream is recycled to the extraction column as the IAX stream. This organic stream appeared to be holding a constant tritium concentration equivalent to about 0.2% of the total entering the system. The three mixer settlers did not remove any significant fraction of tritium from this stream. The IBR stream, with 1.8% of the tritium balance, was recycled to the extraction column as part of the IAF stream. The tritium left the system in the ICP and IAR streams. The ICP stream contained less than 0.1% of the incoming tritium; therefore, by difference, the IAR stream removed about 99.9% of the tritium from the system.

Additional tritium sampling during a campaign in which aluminum-alloy and zirconium-alloy fuels were processed together indicated that, during dissolution of aluminum fuel in nitric acid, approximately 45% of the tritium was released with the dissolver off-gas and 55% entered the extraction system. During dissolution of zirconium fuel in hydrofluoric acid, approximately 90% of the tritium was released to the off-gas and 10% entered the extraction system (Chemical Programs, 1972).

5.2.3 Internal Radiological Exposure Sources from TAN Operations

Radiological operations at TAN have taken place since 1955. TAN was primarily a nuclear reactors operations area with no known radiological separations work, with the exception of the work performed in the area's radiochemistry laboratories. The following categories of radionuclides that were specific to TAN operations are discussed in the subsections below and in Section 7.2.

- Mixed fission and activation products
- Radioiodines (I-129, I-131, I-132, I-133, I-134, and I-135)
- Radioactive noble gases (Ar-41, Kr-85m, Kr-87, Kr-88, Xe-129m, Xe-135, Xe-135m, and Xe-138)

- Plutonium (Pu-238, Pu-239, Pu-240, Pu-241, Pu-242)
- Neptunium (Np-235, Np-237)
- Uranium (U-232, U-233, U-234, U-235, U-236, U-238)
- Other Actinides (Ac-227, Th-228, Th-230, Th-232, Pa-231, Am-241, Am-243, Cm-242, Cm-243, Cm-244, Cm-245, Cm-246)
- Other radionuclides (e.g., H-3, Be-10, C-14, Na-24, Al-28, Fe-55, Co-60, Zn-65, Sr-90, Zr-95, Nb-93, Nb-95, Ag-110, Sb-122, Sb-124, Cs-137, Cs-139, Ce-141, Ce-144, Pr-140, Tm-170, Hf-175, Hf-181, Ta-179, Ta-182, W-185, W-187, Tl-204, Po-210, Ra-226, and others produced by reactor neutron irradiation)

5.2.3.1 Mixed Fission and Activation Products

Mixed fission and activation products have been present at TAN since radiological operations started there in 1955. Fission and activation products were produced by the various reactors at TAN and were received at TAN via shipments of radioactive materials (e.g., irradiated fuels, contaminated equipment). Because radioiodines and radioactive noble gases were periodically present at TAN in significant quantities without any other fission and activation products being present, these fission products are addressed in their own subsections below.

5.2.3.2 Radioiodines

At TAN, radioiodines (e.g., I-129, I-131, I-132, I-133, I-134, and I-135) were produced by the various reactors and with the exception of the IET Facility, appear to have only been released in small quantities. Large quantities of radioiodines were released to the atmosphere as episodic releases from operations at the IET Facility (DOE, 1991, PDF pp. 205-212). During the ANP Program, episodic releases of over 60,000 Ci of radioiodines occurred at the IET Facility. During the SNAPTRAN tests, episodic releases of radioiodines were less than 30 Ci at the IET Facility. Most of the ANP Program releases were via the IET Facility's 150-foot-high stack. However, the releases from the SNAPTRAN tests were not vented via the IET Facility's stack; they occurred at ground level (SNAPTRAN, 1964; SNAPTRAN, 1967).

5.2.3.3 Radioactive Noble Gases

At TAN, radioactive noble gases (e.g., Ar-41, Kr-85m, Kr-87, Kr-88, Xe-129m, Xe-135, Xe-135m, and Xe-138) were produced by the various reactors and, with the exception of the IET Facility, appear to have only been released in small quantities. Large quantities of radioactive noble gases were released to the atmosphere as episodic releases from operations at the IET Facility (DOE, 1991, PDF pp. 205-212). During the ANP Program, episodic releases consisting of over 100,000 Ci of radioactive noble gases occurred at the IET Facility. During the SNAPTRAN tests, episodic releases of radioactive noble gases were less than 2,000 Ci at the IET Facility (DOE, 1991, PDF pp. 205-212; SPERT and SNAPTRAN, 1960s, PDF pp. 65-79 and 82-118).

As discussed in the introduction to Section 5.2.2, because radioactive noble gases do not represent a significant internal exposure concern, NIOSH finds there is no need to assess the internal doses attributable to radioactive noble gases.

5.2.3.4 Plutonium

Plutonium has been present at TAN since radiological operations started there in 1955. Plutonium was produced by the various reactors at TAN, was received at TAN via shipments of radioactive materials (e.g., irradiated fuels, contaminated equipment), was present as non-dispersible radioactive sources, and may have been present as liquid laboratory standards. With the exception of non-dispersible radioactive sources and liquid laboratory standards, the known plutonium at TAN was always present with mixed fission products.

5.2.3.5 Neptunium

Neptunium has been present at TAN since radiological operations started there in 1955. Neptunium was produced by the various reactors at TAN, and was received at TAN via shipments of radioactive materials (e.g., irradiated fuels, contaminated equipment). With the exception of a single shipment of Np-237 to TAN in February 1964 (TAN Shipments, 1963-64), the known neptunium at TAN was always present with mixed fission products. Very little is known about the Np-237 that was shipped in February 1964 other than it was shipped from MTR in solid form and only weighed 8 oz (TAN Shipments, 1963-64).

5.2.3.6 Uranium

Uranium has been present at TAN since radiological operations started there in 1955. At TAN, uranium was used by the various TAN reactors as fuel, was received at TAN via shipments of radioactive materials (e.g., non-irradiated fuels, irradiated fuels, contaminated equipment), may have been present as non-dispersible radioactive sources, and may have been present as liquid laboratory standards. With the exception of non-dispersible radioactive sources, liquid laboratory standards, uranium contamination in the TAN-607 vaults, and potentially, the contamination found in TAN-615, the known uranium at TAN was always present with mixed fission products.

NOTE: During research for the SEC-00219 evaluation report, it was discovered that uranium contamination without mixed fission products was present in the Fuel Storage Vaults of the TAN-607 and TAN-615 buildings. Further investigation is needed to determine the source of the contaminants and the beginning and end dates for the presence of the uranium contamination.

5.2.3.7 Other Actinides

Other actinides (i.e., excluding plutonium, neptunium, and uranium) have been present at TAN since radiological operations started there in 1955. At the TAN, other actinides were produced by the various reactors at TAN, and were received at TAN via shipments of radioactive materials (e.g., irradiated fuels, contaminated equipment, etc.). Based on the available information, the other actinides were never present at TAN without mixed fission products being present.

5.2.3.8 Other Radionuclides

The “other radionuclides” category includes any other radionuclides that were not addressed in the radionuclide categories listed above. This category includes fission and activation products that had

been chemically separated from the other mixed fission and activation products. With the exception of the radionuclides that are specifically addressed below, the majority of the “other radionuclides” at TAN were likely encapsulated experiments or non-dispersible radioactive sources.

Tritium (H-3) is produced by the neutron bombardment of a number of elements, and was likely present as a contaminant in some TAN locations. Sodium-24 (Na-24) is produced by the neutron bombardment of stable sodium, and was likely present as a contaminant in any of the TAN’s sodium-cooled reactors or as part of the sodium contamination of any sodium-cooled reactor parts that came from TAN or other areas (onsite and offsite). Carbon-14 (C-14) can be produced from a number of neutron interactions, and was likely present as a contaminant in carbon, nitrogen, and/or oxygen-bearing materials that were irradiated in nuclear reactors at TAN or other areas (onsite and offsite).

5.2.4 Internal Radiological Exposure Sources from Misc. Reactor Areas Operations

The miscellaneous reactor areas include the Auxiliary Reactor Area (ARA), Organic Moderated Reactor Experiment (OMRE), and the Special Power Reactor Experiment Tests. While each project’s purpose was unique, the radiological sources for internal exposure to personnel had much in common, with the notable exception being ARA-I. ARA-I did not house a reactor, but did have hot cells in support of the Army’s boiling-water and gas-cooled reactor programs, and later supported Test Reactor Area research activities. Radionuclides with the widest application throughout the miscellaneous reactor areas during the period under evaluation are listed below. They are discussed in the following subsections and in Section 7.2.

- Fission and Activation Products
- Exotic radionuclides (e.g., C-14, Ca-45, P-32, S-35, Ba-140/La-140, and others produced by reactor neutron irradiation)
- Radioactive Noble Gases
- Iodine
- Uranium

5.2.4.1 Fission and Activation Products

Fission and activation product exposure potential has existed at INL since the site’s inception because of its mission as the “National Reactor Testing Station.” Radionuclides created from nuclear fission and activation of equipment materials created a variety of beta- and beta-gamma emitting radionuclides. For the miscellaneous reactor areas, fission and activation products were the most significant sources of internal radiation dose. This fact is reflected in the radiobioassay, radiological survey methods, and air sampling programs, which focused on “mixed fission product” monitoring at those facilities.

Fission and activation product exposure occurred as a result of the SL-1 accident. Personnel involved in event response and recovery operations were exposed to airborne radioactive material, including fission and activation products, such as Sr-90 (SL-1 Sr-90 Dose, 1961).

5.2.4.2 Exotic Radionuclides

ARA-I: In 1968, separation of Pa-233 from irradiated thorium slugs from MTR was performed. The facility was modified for the separations work, including upgrades to the ventilation system and addition of isolation boxes. To date, personnel monitoring data have not been found by NIOSH; consequently, this Pa-233 work in ARA-I in 1968 is being reserved for further evaluation.

OMRE: Of the many postulated benefits of the use of liquid hydrocarbons as a moderator and coolant for a reactor was a reduction in the quantities of induced radioactivity. This proved to be true along with other favorable properties, such as low operating pressures resulting in fewer leaks and the rapid solidification of the liquid hydrocarbons if they did leak. A study of the radioisotopic composition of the OMRE coolants after continuous reactor operation from January 1958 to August 1960 verified this benefit. The study measured the radionuclides listed in Table 5-11. The principal gamma-emitting isotopes were Mn-56, Fe-59, Mn-54, As-76, and Se-75. The primary beta-emitting isotopes were P-32, H-3, S-35, Fe-55, and C-14. Activation of trace impurities is believed to have been the source of most of the radionuclides identified, although C-14 and H-3 activity was judged to be from activation of the organic coolant (OMRE, 1961).

Table 5-11: Radionuclides Measured in OMRE Coolant		
Radionuclide	Half-Life	Activity in Coolant ($\mu\text{Ci/gm}$)
Mn-56	2.6 h	3.8E-01
P-32	14.22 d	2.8E-01
H-3	12.2 y	1.8E-01
S-35	87 d	3.8E-02
Fe-55	2.6 y	3.0E-02
C-14	5568 y	2.5E-02
Fe-59	44.3 d	1.7E-02
As-76	26.5 h	9.9E-03
Mn-54	300 d	7.3E-03
Se-75	121 d	7.2E-03
Na-24	14.9 h	1.7E-03
Co-58	71.3 d	1.6E-03
Cu-64	12.8 h	1.6E-03
Ba-140	12.8 d	8.5E-04
Sb-122	2.75 d	8.1E-04
I-131	8 d	8.1E-04
Co-60	5.24 y	7.8E-04
Zn-65	246 d	5.9E-04
Cs-137	30 y	4.5E-04
Zr-95	65 d	3.3E-04
Sr-90	27.7 y	7.7E-05

5.2.4.3 Radioactive Noble Gases

Radioactive noble gases were produced at the Misc. Reactor Areas but typically in small quantities, as shown in the example provided in Table 5-12. Noble gases did not represent a major internal exposure concern. ARA and SPERT both used a central control room at distances of approximately 500 meters and 0.5 miles, respectively, from the reactors they operated. In addition to distance, SPERT relied on site security to monitor the SPERT perimeter during testing, as well as meteorological data for taking radiological measurements downwind from releases (SPERT and SNAPTRAN, 1960s; SPERT Dosimetry, 1957-58).

Table 5-12: Example Air Effluent Inventory for SL-1 (ARA-II)		
Time Period	Radionuclides	Total Activity (Ci)
3 rd Quarter 1959	Kr-85, Kr-88, Xe-133, Xe-135, Xe-138	44.13
4 th Quarter 1959	Kr-85, Kr-88, Xe-133, Xe-135, Xe-138	73.10
1 st Quarter 1960	Kr-85, Kr-88, Xe-133, Xe-135, Xe-138	41.5
2 nd Quarter 1960	Kr-85, Kr-88, Xe-133, Xe-135, Xe-138	59.1

Source: SL-1 Safety, 3Q-1959; SL-1 Safety, 4Q-1959; SL-1 Safety, 1Q-1960; SL-1 Safety, 2Q-1960

After the first destructive test at SPERT I, only the daughters of noble gases were detected by gamma spectroscopy of downwind air samples. The following radionuclides were detected: Sr-91, Y-91, Sr-92, Y-92, and Ba-139 (SPERT-I, 1965).

As discussed in the introduction to Section 5.2.2, because radioactive noble gases do not represent a significant internal exposure concern, NIOSH finds there is no need to assess the internal doses attributable to radioactive noble gases.

5.2.4.4 Iodine

Isotopes of iodine are produced in high yield during fission; their short half-lives permit equilibrium concentrations to be built up rapidly. Considerable inventories of these isotopes are present after only a short duration of reactor operation. Because radioiodines are gases, they are subject to release if fuel-element-cladding integrity is breached. Consequently, radioiodines were not typically a concern for internal radiological exposures for the miscellaneous reactor areas. However, radioactive isotopes of iodine, primarily I-131, were detected in gross amounts after the SL-1 accident (Nelson, 1961). Three-hundred-sixty urine samples were collected from 180 workers and analyzed for I-131 by gross-gamma counting post-event. Fourteen workers were placed on follow-up urine sampling programs to determine urinary excretion (SL-1 Report, 1961). In addition, thyroid counts were performed at the CPP Dispensary on all workers associated with the SL-1 event (SL-1 Chronology, 1961).

5.2.4.5 Uranium

ARA: Uranium exposure potential at ARA was primarily centered at the ARA-I hot cells where irradiated fuel was examined; however, due to remote handling, this potential was considered small. After shutdown and a 24-hour period for radiation levels to decline, the ARA reactor fuel elements would be transferred to a handling cask for transport to the ARA hot-cell facilities for examination. The steam explosion and subsequent core meltdown at SL-1 on January 3, 1961 resulted in the release of a multitude of radionuclides, including uranium. SL-1 used a highly-enriched uranium fuel core that resulted in dispersion at the accident site. Analysis of samples taken from SL-1 post-incident and analyzed at the Central Facilities radiochemistry laboratory showed the uranium to be composed of the following radionuclides by mass: 1% U-234, 91% U-235, 2% U-236, and 6% U-238 (SL-1 Report, 1961).

SPERT: Only the planned destructive tests at SPERT I between November 1962 and April 1964 showed any damage to the uranium cores used. The first SPERT I destructive tests used highly-enriched uranium with an aluminum cladding, while the second and third destructive tests used a low-enrichment UO₂ pin core. The first test resulted in damage to the core but without measureable uranium released. The second and third tests showed little damage to the uranium fuel pins (SPERT-I, 1965).

5.2.5 Internal Radiological Exposure Sources from CFA Operations

Radionuclides with the widest application throughout the Central Facilities Area during the period under evaluation are listed below. They are discussed in the following subsections and in Section 7.2.

- Fission and Activation Products
- Uranium

Any other potential exposures from exotics or other radionuclides would be dominated by the mixed fission products and uranium exposures at the CFA Laundry Facility.

5.2.5.1 Fission and Activation Products

As fission and activation products were the primary contaminants at INL, protective clothing would, as expected, become contaminated during use. Contaminated laundry generated at INL was sent to the CF-669 Laundry Facility in the Central Facilities Area for cleaning. Laundry personnel were cognizant of the mixed fission product hazard as Safety Work Permits (SWPs), protective clothing, and film badges were required precautions. Paperwork, including contamination levels, was required to be completed by all contaminated-laundry generators. Laundry was required to be sorted by type (coveralls, shoe covers, etc.) and contamination level (0-10 mR/hr, 10-100 mR/hr, and >100 mR/hr) (Savignac, 1961, PDF p. 13). There was a dirty-laundry reception area equipped with a radiation detector above the entry door and a CAM in the laundry area itself.

5.2.5.2 Uranium

Central Facilities had a fully-equipped machine shop (CF-640) that was used for work that other plant areas could not handle. The materials brought to the machine shop had to be of low radiation and contamination levels (Stroschein, 1967). An example of a uranium source was un-irradiated SPERT fuel that was sent to CF-640 for work that required minor drilling (Shipment Records, 1960s).

5.2.6 Internal Radiological Exposure Sources from Burial Ground Operations

Radionuclides with the widest application for the Burial Ground during the period under evaluation are listed below. They are discussed in the following subsections and in Section 7.2.

- Fission and Activation Products
- Plutonium

Any other potential exposures from exotics or other radionuclides would be dominated by the mixed fission product exposures at the Burial Ground. In late 1969, some experimental equipment that was accidentally buried in Pit 1 was retrieved; this marked the first time in the history of the Burial Ground that buried waste was deliberately exhumed. Further NIOSH evaluation is required of the personnel monitoring data for waste-retrieval activities, necessitating reservation of the Burial Ground from 1969 forward.

5.2.6.1 Fission and Activation Products

INL-generated waste was virtually all mixed-fission-product waste and was buried in trenches as low-level waste (LLW). The volume and curie content of the LLW are presented in Table 5-13. Most routine wastes were packaged in cardboard boxes, sealed with tape, and placed in designated Dempster Dumpster containers for disposal. By 1957, a routine schedule had been established to pick up INL-generated solid waste (RWMC History, 1985).

Table 5-13: Solid Radioactive Waste at INL Burial Ground						
Year	Buried LLW		Buried TRU		Stored TRU	
	Volume (m³)	Ci	Volume (m³)	Ci	Volume (m³)	Ci
1952-1960	18,475	60,920	10,545	11,300	NA	NA
1961	6,091	155,650	2,439	3,650	NA	NA
1962	5,730	115,320	2,439	3,780	NA	NA
1963	5,445	251,480	2,755	10,520	NA	NA
1964	3,132	146,330	3,357	12,270	NA	NA
1965	4,076	685,890	3,764	17,010	NA	NA
1966	4,634	859,010	3,454	65,290	NA	NA
1967	3,820	836,130	4,859	41,670	NA	NA
1968	3,947	268,810	5,826	32,690	NA	NA
1969	4,740	935,520	9,791	35,480	NA	NA
1970	4,151	482,640	8,429	15,460	1,420	4,225

Source: RWMC History, 1985

Note: All radioactivity values are at time of disposal or storage.

5.2.6.2 Plutonium

The INL Burial Ground began receiving shipments of Rocky Flats waste in 1954 and continued to receive routine shipments past the end of the period under evaluation for this report. Table 5-14 presents estimated quantities of the radionuclides received from Rocky Flats between 1954 and 1970.

Table 5-14: Estimated Quantities of Radioactive Materials From Rocky Flats								
Year	U-238 (kg)	U-235 (g)	Pu-238 (g)	Pu-239 (g)	Pu-240 (g)	Pu-241 (g)	Pu-242 (g)	Am-241 (g)
1954	733	180	0.02	239.09	14.94	0.90	0.04	14
1955	979	870	0.15	1,529.26	95.54	5.79	0.26	26
1956	1,174	1,108	0.22	2,266.23	141.59	8.58	0.38	28
1957	2,147	1,616	0.30	3,184.16	198.94	12.05	0.54	43
1958	4,209	5,009	0.41	4,320.55	269.93	16.36	0.74	61
1959	3,753	11,319	0.46	4,800.61	299.93	18.18	0.82	62
1960	4,123	16,481	0.34	3,553.84	222.06	17.15	0.61	46
1961	4,311	13,921	0.53	5,538.71	346.09	26.73	0.95	70
1962	4,674	4,493	0.50	5,272.52	323.14	24.95	0.88	180
1963	1,672	6,269	1.53	15,944.51	996.30	76.94	2.72	204
1964	1,339	7,888	1.79	18,586.94	1,161.41	89.69	3.17	238
1965	4,269	4,066	2.43	25,340.54	1,583.41	122.28	4.33	414
1966	53,452	1,688	8.73	90,820.55	5,674.95	438.25	15.51	2,815
1967 ^a	53,176	1,889	5.4	56,231.04	3,513.61	271.34	9.60	2,129
1968	33,373	1,210	4.18	43,543.44	2,720.83	210.11	7.44	1,778
1969	22,721	36,259	3.25	38,046.37	2,376.93	149.34	6.49	4,875
1970	7,084	14,196	2.58	24,178.81	1,517.63	105.82	5.16	1,834
Totals	203,194	128,467	32.82	343,296.17	21,457.23	1,594.46	59.64	14,817

^a Includes 56 g U-233 (RFP Waste, 2005)

Waste from Rocky Flats primarily came in the form of sealed 55-gallon drums, but 30-gallon drums were also used. In addition, crates and wooden boxes were used for oversized waste shipments (RWMC History, 1979). Rocky Flats waste was buried in large quantities at one time, as recorded on monthly off-site radioactive waste disposal reports (Waste Shipments, Feb1963; Waste Shipments, Mar1963; Waste Shipments, Apr1963; Waste Shipments, May1963; Waste Shipments, Jun1963; Waste Shipments, Jul1963; Waste Shipments, Aug1963; Waste Shipments, Nov1963). The Central Facilities health physicist was required to be present for all waste emplacements and performed contamination surveys before and after the job.

In 1962, a complete survey of the Burial Ground was performed after the “Chinook” flood event caused the movement and disarrangement of some waste. Particular attention was paid to open Pits #2 and #3 and open Trenches #25 and #26, which had filled with water during the flood and overflowed. The only alpha contamination found was 5,000 dpm on the sides of Pit #2 and 50,000 dpm at the bottom of Pit #2. No alpha contamination was found outside the pit. It should be noted that the isotopic composition of the alpha contamination was not mentioned, but the initial burial pits were excavated for oversized waste from Rocky Flats (HP Monthly Reports, 1962).

5.3 External Radiological Exposure Sources from INL Operations

To provide consistency of radiation safety programs at the INL amid a large variety of facilities and constantly-changing contractors, the AEC established a Health and Safety (H&S) Laboratory at INL to provide technical support for internal and external dosimetry programs. The name of this organization was changed to Health Services Laboratory (HSL), then to the Health and Safety Division (HSD), then to the Idaho Center for Radiological and Environmental Sciences, and most recently, to the Radiological and Environmental Sciences Laboratory (RESL) (ORAUT-TKBS-0007-6).

By policy, INL monitored by dosimeter all personnel who were expected to receive any radiation dose or whose work was centered at the site (Cipperley, 1968; CPP HP Manual, 1952; Cipperley, 1958). Dosimeters were usually stored at the operational area entrance security gates.

Table 5-15 shows a historical summary of INL beta-gamma dosimetry systems and their corresponding Limits of Detection (LODs).

Table 5-15: INL Beta-Gamma Dosimetry Systems History and LOD Summary				
Period of Use ^a	Dosimeter	Exchange Frequency	LOD ^b (mrem)	
			Beta	Gamma
August 1951– March 1958	INL initial film, 552 DuPont film	Weekly (n=52)	30	30
		Monthly (n=12)		
	Reactor areas, DuPont 558 film	Weekly (n=52)	30	10
March 1958– December 1966	INL multielement DuPont 508 film	Weekly (n=52)	30	10
		Biweekly (n=26)		
		Monthly (n=12)		
December 1966– February 1974	INL multielement DuPont 508 film	Weekly (n=52)	30	10
		Biweekly (n=26)		
		Monthly (n=12)		
	INL LiF TLD	Quarterly (n=4)	15	15
		Semi-ann (n=2)		
		Annual (n=1)		
February 1974– May 1975 ^c	INL Atlas TLD LiF in Teflon	Monthly (n=12)	30	30
		Quarterly (n=4)		
		Semi-ann(n=2)		
		Annual (n=1)		
December 1974- December 1985 ^c	INL Harshaw two-chip TLD	Monthly (n=12)	15	15
		Quarterly (n=4)		
		Annual (n=1)		
January 1986–2006	INL Panasonic four-chip TLD	Monthly (n=12)	15 ^c	15 ^d
		Quarterly (n=4)	30 ^c	10 ^d
		Monthly (n=12)		
		Quarterly (n=4)		

Source: This table derived from Table 6-15 in ORAUT-TKBS-0007-6.

- For many years, INL workers had a dosimeter assigned to each operating area where they worked, or they were issued visitor dosimetry. All-area dosimetry was issued beginning in January 2000.
- LODs are based on: Cipperley, 1958; Cipperley, 1968; Cusimano, 1963; Kalbeitzer, 1983; Gesell, 1986; Gesell, 1992; Perry, 1993; Ruhter, 2002.
- ICPP began using the Harshaw TLD in December 1974, the prime contractor began in February 1975, and ANL-W began in May 1975.
- The LOD was 15 mrem from January 1, 1986 to July 7 1986; 10 mrem from July 7, 1986 to September 1989; and 15 mrem until 1993, when it returned to 10 mrem.
- The LOD was 15 mrem from January 1, 1986 to July 7 1986 and 30 mrem after that.

Table 5-16 shows a historical summary of INL neutron dosimetry systems and their corresponding Limits of Detection (LODs).

Table 5-17 lists the principal gamma-emitting fission products that could be expected in the primary feed and waste solutions. NOTE: The list begins in the left half of the table and continues in the right half of the table.

Table 5-16: INL Neutron Dosimetry Systems History and LOD Summary			
Period of Use	Dosimeter	Exchange Frequency	LOD (mrem)
1951–1958	NTA Film (Kodak Type A Film)	Weekly (n=52)	14 ^a
1959–September 1976	NTA Film (Kodak Type A Film)	Weekly (n=52)	20
		Biweekly (n=26)	
		Monthly (n=12)	
January 1986–2006	INL Panasonic four-chip TLD	Monthly (n=12)	15 ^b
		Quarterly (n=4)	
		Monthly (n=12)	

Source: This table derived from Table 6-16 in ORAUT-TKBS-0007-6.

a. Cipperley, 1958, PDF p. 20

b. Gesell, 1996, PDF p. 19

Table 5-17: Mixed Fission Product Gamma and Beta Emitters							
Nuclide	Half-Life (y)	Photon Energy (MeV)	Max. Beta Energy (MeV)	Nuclide	Half-Life (y)	Photon Energy (MeV)	Max. Beta Energy (MeV)
Selenium-79	3.27 x 10 ⁵	-	0.149	Samarium-151	96.6	-	0.076
Krypton-85	10.76	-	0.687			Europium-155	4.76
Strontium-90	28.9	-	0.546	-	0.141		
Zirconium-93	1.53 x 10 ⁶	-	0.062	-	0.159		
Niobium-95 ^(a)	35 d	0.765	0.160	-	0.186		
		1.121	-	-	0.246		
Technetium-99	2.11 x 10 ⁵	-	0.294	Terbium-160	72.3		
Rhodium-106 ^(b)	368.2 d	0.512	1.979			0.216	0.475
		0.622	2.407			0.299	0.546
		1.051	3.029			0.392	0.569
		-	3.541			0.765	0.784
Palladium-107	6.5 x 10 ⁶	-	0.033			0.879	0.867
Cadmium-113m	14.1	-	0.586			0.962	1.747
Tin-126	2.3 x 10 ⁵	-	0.250			0.966	-
Iodine-129	1.57 x 10 ⁷	-	0.152			1.115	-
Cesium-135	2.3 x 10 ⁶	-	0.205			1.178	-
Cesium-137	30.23	-	0.511			1.200	-
		-	1.173			1.272	-
Barium-137m ^(c)	2.552 min	0.662	-	1.312	-		
Praseodymium-144 ^(d)	17.28 min	0.696	0.810	---			
		-	2.300				
		-	2.996				

Source: CPP Fact Sheet, undated

Notes:

- (a) Decay product from zirconium-95
- (b) Decay product from ruthenium-106
- (c) Decay product from cesium-137
- (d) Decay product from cerium-144

5.3.1 External Radiological Exposure Sources from Test Reactor Area Operations

5.3.1.1 Photon

Photon exposure resulted from mixed fission and activation products and isotopes produced by reactors and from separations of Pa-233 performed in the MTR alpha cave. Exposure rates varied by dates, but generally, exposure potential increased with time due to increased production and the increasing number of reactors, in 1957 and in 1967. The radiation fields at TRA, with a few exceptions, were generated primarily by mixed fission and activation products. Therefore, most of the photon dose has been from photons with energy greater than 250 keV (ORAUT-TKBS-0007-6, PDF p. 26).

5.3.1.2 Beta

Beta exposure resulted from mixed fission and activation products and isotopes produced by reactors. Exposure rates varied by dates, but generally, exposure potential increased with time due to increased production and the increasing number of reactors, in 1957 and in 1967. The radiation fields at TRA, with a few exceptions, were generated primarily by mixed fission and activation products. Beta dose resulted primarily from exposure to electrons with greater than 15 keV (ORAUT-TKBS-0007-6, PDF p. 28).

5.3.1.3 Neutron

Test Reactor Area workers may have been exposed to neutrons from the existing nuclear reactors and from neutron sources. Shipping transactions indicate the likely receipt of polonium-beryllium and radium-beryllium sources though NIOSH has not located documentation on number and strengths of such sources. Table 5-1 lists all TRA reactors in existence from 1952 through 1970. There was also potential for neutron exposure from the Fast Chopper and Crystal Spectrometer.

5.3.2 External Radiological Exposure Sources from CPP Operations

5.3.2.1 Photon

Photon exposure resulted from the mixed fission and activation products from the reactor fuels processed at CPP. The workplace photon energy spectra at CPP would have been dominated by high-energy photons from mixed fission and activation products. Pa-234m is a decay product in the U-238 decay chain and emits a 2.29 MeV beta particle. A significant quantity of photons resulting from Bremsstrahlung radiation are produced and contribute photons of intermediate energy (30-250 keV). Although enriched uranium has significantly less in-growth of Pa-234m, U-235 and its decay products emit a 185.7 keV photon 57% of time and a 143.8 keV photon 11% of the time. These photons dominate the measured photon energy spectra in the product streams.

The majority of radioactivity in process raffinate solutions and calcined wastes were from the long and medium half-life fission products. The most significant gamma activity would have been from cesium-137 decaying to barium-137m and its subsequent gamma emission, as well as the decays of europium-154, ruthenium-106, and cerium-144. To a lesser degree, gamma activity would also result from the decay of rhodium-106 and praseodymium-144.

Because fuels used in the RaLa process were cooled for only two days rather than the 90-120 days used for other process streams, there would be a large population of short-lived fission products present in the fuel and wastes.

In addition to the fission product gamma rays, gamma rays from the activation of fuel cladding and structural materials, such as Mn-54, Co-58 and Co-60, would also be present, but would vary depending on the type of fuel being processed at the time.

Each of the process cells was constructed with five-foot-thick concrete walls to shield operators from the radiation fields. The penetrations of the walls contained bends, thereby preventing radiation leakage from the inside the cell. However, radioactive process fluids may have gotten into exposed instrument leads and parts of the pulse pump systems that normally would be clean. The introduction of these highly-radioactive fluids into lines in the Operating Corridor and the Access Corridor could give rise to high radiation fields (Stroschein, 1967).

Table 5-18 lists the mixed fission products resulting from the RaLa process. NOTE: The list begins in the left half of the table and continues in the right half of the table.

Legend For Table 5-18 (next page):

- (a) Emissions with yields of less than 1% or energies of less than 100 keV are not reported
- (b) Te-131 emits 93 different photons. Only those with yields greater than 10% are reported here.
- (c) Promethium-151 emits 76 different photons. Only those with yields greater than 10% are reported.

Table 5-18: Mixed Fission Products from the RaLa Process							
Nuclide	Half-Life (d)	Photon Energy (MeV) ^(a)	Max. Beta Energy (MeV) ^(a)	Nuclide	Half-Life (d)	Photon Energy (MeV) ^(a)	Max. Beta Energy (MeV) ^(a)
Sr-89	50.55	0.909	1.491	La-140	1.68	0.329	1.239
Y-91	58.51	1.205	1.543			0.433	1.244
Zr-95	64.02	0.724	0.366			0.487	1.279
		0.757	0.399			0.752	1.296
Nb-95	35.00	0.765	0.160			0.816	1.348
		1.121				0.868	1.412
Ru-103	39.35	0.497	0.113			0.920	1.677
		0.610	0.226			0.925	2.164
Rh-105	1.47	0.306	0.248			1.597	-
		0.319	0.261			2.522	-
Ag-111	7.46	0.245	0.686	Ce-141	32.5	0.145	0.435
		0.342	0.723			-	0.580
		-	1.028	Ce-143	1.38	0.232	0.517
Cd-115	2.23	0.261	0.184			0.293	0.733
		0.336	0.197			0.351	1.104
		0.492	0.267			0.490	1.398
Sn-125	9.64	0.528	0.394	0.665	-		
		0.332	0.348	0.722	-		
		0.270	0.367	Pr-143	13.56	-	0.935
		0.823	0.460			0.319	0.210
		0.916	1.261	Nd-147	10.98	0.440	0.365
		1.067	2.350			0.531	0.805
Te-129m	33.6	1.089	-	Pm-149	2.21	0.286	0.785
		2.001	-			-	1.071
		0.275	0.908	0.340 ^(c)	0.235		
		0.031	1.604	-	0.310		
Te-131m	1.25	0.696	-	Pm-151	1.18	-	0.365
		0.774	0.317			-	0.414
		0.794	0.420			-	0.447
		0.852	0.430			-	0.742
		1.126 ^(b)	0.451			-	0.792
		-	0.507			-	0.843
		-	0.532			-	0.864
		-	0.544			-	0.881
		-	0.785			-	0.979
-	2.431	-	1.020				
Te-132	2.26	0.112	0.215	Sm-153	1.95	0.103	0.632
		0.116	-			-	0.702
		0.228	-			-	0.805
I-131	8.04	0.284	0.248	Eu-156	15.19	0.646	0.183
		0.364	0.334			0.723	0.248
		0.637	0.606			0.812	0.266
		0.723	-			1.065	0.426
Xe-133	5.25	-	0.346			1.153	0.487
Ba-140	12.79	0.163	0.454			1.154	1.087
		0.305	0.567			1.231	1.211
		0.424	0.872			1.242	1.285
		0.438	0.991			-	1.404
		0.537	1.005	-	2.453		

5.3.2.2 Beta

Beta exposure resulted from the mixed fission and activation products from the reactor fuels processed at CPP. Most fission products are initially rich in neutrons and undergo beta decay. The beta emissions for regular process fuels and RaLa fuels are presented in Table 5-17 and Table 5-18, respectively.

In general, the thick shielding afforded by the cell walls would attenuate any beta particles emitted. However, at the end of a production run, it was usually necessary to perform maintenance work on the process piping, vessels, and instrumentation within the cells (Stroschein, 1967). Cell entry would have required the filing of a special work permit (CPP HP Manual, 1952). Before anyone attempted to enter the cells, it was necessary to decontaminate the piping and vessels internally. This was done by remote control and would result in reduction to acceptable work levels of radiation from the process piping (Stroschein, 1967). For a cell entry, an acceptable work level would be a dose-based limit of 300 mrem/week.

If there was leakage of radioactive solutions from any part of the process system, the cell walls, the floor, and external areas of the piping and vessels may have become highly contaminated. A spray system was built into each cell to wash down the process system exteriors and cell surfaces. This was designed to reduce the radiation to a level that permitted removal of the top hatch and subsequent surveys by Health Physics personnel.

Despite the above mitigating actions, hot spots may have persisted either inside or outside of the process system. It was, therefore, often necessary to provide temporary shielding to allow work to be done in the cells. Even so, the allowable work time may have been limited for certain tasks, and the health physicist was required to maintain tight control over this aspect of the work (Stroschein, 1967).

5.3.2.3 Neutron

Neutron exposure could have resulted from the separations processes and product lines, which handled quantities of TRU isotopes and the associated spontaneous fission and α/n neutrons produced. Uranium present in a neutron flux can capture neutrons, producing transuranic nuclides. Many of these nuclides produce neutrons through spontaneous fission. Alternately, these nuclides may decay by alpha emission which, if this decay occurs in the presence of a low-atomic-number material, may lead to the production of neutrons via the (α,n) reaction.

5.3.3 External Radiological Exposure Sources from TAN Operations

Radiological operations have taken place at TAN since 1955. TAN was primarily a nuclear reactors operations area.

5.3.3.1 Photon

Based on a review of the available INL records, the photon radiation fields at TAN were generated primarily by the operation of nuclear reactors, activated materials, and irradiated reactor fuels. Photon energies were predominately greater than 30 keV (ORAUT-TKBS-0007-6). Photon radiation fields at TAN are known to have ranged from immeasurable levels to over 1E+6 mrem/hr. The higher dose

rates in this range were from unshielded test reactors where personnel were typically protected either by distance, underground shielded bunkers, or both.

5.3.3.2 Beta

Based on a review of the available INL records, the non-penetrating radiation fields at TAN were generated primarily by activated materials, irradiated reactor fuels, and radioactive contamination from those materials. Because there is no indication of separated plutonium at TAN (with the exception of some laboratory standards), all non-penetrating radiation at TAN is attributable to electron (beta) radiation. Electron energies were predominately greater than 15 keV (ORAUT-TKBS-0007-6). Electron radiation fields at TAN are known to have ranged from immeasurable levels to over 1E+3 mrem/hr.

5.3.3.3 Neutron

Based on a review of the available INL records, the neutron radiation fields at TAN were generated primarily by the operation of nuclear reactors and irradiated reactor fuels. Shipping transactions and other records indicate the presence of polonium-beryllium, plutonium-beryllium, and radium-beryllium neutron sources. However, NIOSH has not located documentation on the number and strengths of those neutron sources. Neutron energies were generally less than 20 MeV (ORAUT-TKBS-0007-6). Neutron radiation fields at TAN are known to have ranged from immeasurable levels to over 1E+6 mrem/hr. The higher dose rates in this range were from unshielded test reactors where personnel were typically protected either by distance, underground shielded bunkers, or both.

5.3.4 External Radiological Exposure Sources from Misc. Reactor Areas Operations

5.3.4.1 Photon

Photon exposure resulted from photon radiation produced during nuclear fission. In addition, many of the fission and activation products resulting from fuel irradiation decay by photon emission. The workplace photon energy spectra in the Misc. Reactor Areas would have been dominated by high-energy photons from mixed fission and activation products. OMRE was slightly different in that Mn-56 contributed approximately 80% of the detected radiation from operations (OMRE, 1961).

The SPERT and Auxiliary Reactor Area reactors were operated from remote-control rooms. One of the designed benefits was the control of direct radiation hazards to workers through the following mechanisms:

- Evacuation of personnel during reactor operations
- Health physics and security control of access
- Remote area monitors with read-outs in control rooms
- Time delay to allow decay of short-lived radionuclides before reentry

Based on a review of available records, the highest external exposure potential from photons in the Auxiliary Reactor Area occurred at SPERT-I during removal of the fuel elements from the reactor. Under normal operations, fuel elements were transferred using a six-foot handling tool, without

shielding, with approximately 10 seconds required for the transfer. External dose rates would range up to 20 R/hr at 5 feet (Mills, 1957). "Incident reports" were generated for workers whose external exposures exceeded an established control limit during the film badge wear period (SPERT Incident, 1957; McVey, 1956).

5.3.4.2 Beta

Reactor operations in the Misc. Reactor Areas did not have pure beta external hazards, but non-penetrating exposures would have resulted from the mixed fission and activation products produced by the reactors. Whether beta radiation was considered an external hazard depended on the maximum energy of the beta emission for a given radionuclide, any shielding used, and the use of protective clothing (Mills, 1957a). Beta energies were predominantly greater than 15 keV (Measurement Procedures, 1983).

5.3.4.3 Neutron

Operating reactors would have been the primary source of neutron exposure during the period under evaluation. These reactors were experimental facilities for measuring shielding factors, reactor kinetics, and neutron irradiation. The SL-1 reactor was caused by the improper withdrawal of one of the cadmium control rods, resulting in prompt neutrons creating steam formation in milliseconds. In addition, neutron sources such as PoBe, RaBe, and PoB sources were used at INL (H&S Bulletin, 1958).

5.3.5 External Radiological Exposure Sources from CFA Operations

5.3.5.1 Photon

Though the Central Facilities Area performed a support role for INL operations, there were sources of external photon exposure due the following functions:

- Receipt and survey of radioactive shipments
- Contaminated laundry facility
- Machine shop and vehicle maintenance

Central Facilities served as the transportation center for INL. All incoming and outgoing radioactive shipments by rail or trailer trucks were routed through CFA. Radioactive Shipment Records, which included radiation and contamination survey results, were required for all shipments; examples are available (McCaslin, 1953; Incoming Shipment Records, 1961).

The CF-699 Laundry facility routinely handled laundry of various external dose rates and contamination levels from mixed fission and activation products found on the contaminated laundry. Photon dose rates of contaminated laundry were documented on Radioactive Shipment Records for shipments to CF-699 (Sommers, 1959). In addition, Waste Disposal Request and Authorization forms generated by CF-699 demonstrate measurable photon dose rates for shipments to the Burial Ground for disposal (Belnap, 1963).

The CF-640 Machine Shop on occasion would receive low-radiation material for work. Photon exposures were also possible at the CF-665 Vehicle Maintenance Shop, where transportation equipment was serviced and, when necessary, sent to CPP for decontamination (Stroschein, 1967).

5.3.5.2 Beta

Beta exposure at CFA would have resulted from mixed fission and activation products and any other beta-emitting isotopes produced by reactors. Potential for non-penetrating external exposures would have been highest at the CF-699 Laundry facility. Beta energies were predominantly greater than 15 keV (Measurement Procedures, 1983).

5.3.6 External Radiological Exposure Sources from Burial Ground Operations

5.3.6.1 Photon

Photon exposure at the Burial Ground would have resulted from radioactive waste generated at INL, other waste generators between 1960 and 1963 when INL was designated an interim burial ground by the AEC, and the Rocky Flats Plant. Photons from INL-generated waste would have been dominated by high-energy photons from mixed fission and activation products. The Burial Ground routinely accepted INL waste with dose rates not to exceed 500 mR/hr at one meter from the container (Burial Ground, 1962). In addition to routine waste, non-routine waste (defined as dose rates greater than 500 mR/hr at one meter) that could cause excess personnel exposure was transported in special containers and transfer vehicles. These disposals were always carried out under the supervision of a health physicist and typically scheduled outside normal operating hours. At least up to 1957, no upper limit had been set on the level of radiation that could be handled; items of up to 12,000 R/hr were buried (RWMC History, 1985). During its years as an interim burial ground, INL received a great deal of beta-gamma-contaminated waste from other AEC contractors, university, private industry, and the armed forces.

Shipments of Rocky Flats waste began in 1954. Up until 1963, most of the waste drums from Rocky Flats were stacked by hand. Beginning in November 1963 and lasting until late 1969, RFP waste containers were no longer stacked, but were dumped into the pits to reduce labor costs and minimize personnel photon exposures. Consideration was made for Am-241 in-growth from the Pu-241 constituent of Rocky Flats waste since Am-241 is an external dose hazard due to the 59.5 keV photon emitted by its predominant decay mode (Johnson, 1969). In 1967, wastes generated during U-233 processing were packaged in lead-lined drums to reduce personnel exposure prior to shipment to INL (RFP Waste, 2005).

5.3.6.2 Beta

Non-penetrating radiation at the Burial Ground would have originated from the mixed fission and activation products produced at INL and any beta-emitting radionuclides that were sent to the Burial Ground when it was an interim storage facility. However, given the shielding afforded by waste containers and waste dumping and burial methods, beta radiation as an external hazard would have been minimal compared to photon radiation. Beta energies were predominantly greater than 15 keV (Measurement Procedures, 1983).

5.4 Incidents

INL facilities and activities involved experimental reactor design and development, irradiated fuel processing, and low- and high-level radioactive waste treatment and disposal. INL's monitoring and analytical programs were designed to initiate an investigation of any potential internal intake as indicated by off-normal workplace indicators such as personnel contamination or positive air sampling. NIOSH found extensive personal monitoring data for mixed fission and activation products (beta/gamma); therefore, only external exposures of regulatory significance, fire and flood events at the Burial Ground, significant alpha-contamination incidents, and criticality incidents are presented below.

5.4.1 Incidents at the Test Reactor Area

From the onset of MTR operations through the end of the period under evaluation (1970), incidents occurred in the TRA that released airborne fission and activation products. Releases at the reactors and reactor canals occurred from opening of the reactor top after reactor shutdown, infrequent breach of casks and transfer rabbits (HP Monthly Reports, 1959-1960). Similar releases occurred inside the MTR hot cells (Johnson, 1965a; Johnson, 1961; Sommers, 1957a). Infrequent releases of fission product materials also occurred in the MTR labs. Releases of fission products resulted in airborne and surface beta and gamma contamination. After releases of fission products, TRA Health Physics monitored workers with potential for internal intakes by urinalysis or whole-body counting. Starting in 1954, TRA Health Physics used gamma-ray spectroscopy to identify unknown contaminants from incidents. One example was the identification of Cl-38 from an airborne release detected at both the MTR reactor top and the main floor on December 16, 1958 (Keller, 1958). Health Physics performed follow-up monitoring of areas affected by incidents until conditions were safe for workers to re-enter. NIOSH examined documented reports of releases of fission products from 1957 through 1970. Health Physics did post-incident follow-up either by air sampling or worker bioassay for each of those documented incidents (HP Monthly Reports, 1959-1960). NIOSH found the bioassay results for workers identified in the reports in the data supplied by INL. NIOSH closely examined incident records involving the release of alpha-emitting radionuclides. The incidents taking place in the TRA are discussed below:

- Unshielded Reactor Component at the MTR, July 23, 1956: A radioactive reactor component at the Materials Testing Reactor was not adequately shielded, resulting in radiation exposures above current standards to four employees. While the reactor was shut down for scheduled refueling, the water level in the reactor tank was lowered, and the component was moved to facilitate the insertion and removal of experiments in the reactor. During this procedure, the radioactive component was partially exposed. [Number redacted] employees working on the reactor top adjacent to the reactor tank opening and two [roles redacted] received radiation exposures. [Number redacted] employees received a 21.5 rem exposure, which exceeded the 15-rem-per-year standard in effect in 1956 as well as the current-day 5-rem standard. In addition to [number redacted] employees received radiation exposures that exceed the current-day standard. These employees received radiation exposures of 6.15 rem, 6.2 rem and 10.6 rem. The other [number redacted] employees received radiation exposures below 5 rem.

- Alpha Incident, MTR Lab 109, January 1956: Over the period of a week, a group of researchers from [organization name redacted] were found by Health Physics to not be practicing good contamination control in an area not designated as “clean” (Labs 109 and 110). The researchers were found drinking sodas at one point, and later, with messy housekeeping. Contaminated trash was found in a trash can in Lab 110. On January 23, the researchers were found to be cutting a hot sample at the rabbit canal without wearing protective clothing. Some material at the canal was found to be contaminated. Airborne contamination was continuously monitored. Health Physics monitored the labs for contamination and contaminated areas were subsequently cleaned. The [organization name redacted] researchers were given Health Physics indoctrination (Sommers, 1956).
- Personal Contamination, August 1958: A worker received an open wound while lathing U-235 in the [location redacted] Lab. The wound was determined to be contaminated. The worker was assayed using urinalysis. No internal intakes were detected (Sommers, 1959a).
- Lab Contamination, May 1960: A wide area of MTR Metallurgical Lab was contaminated from work with U-235, although the source was not identified. Smears of alpha contamination gave a maximum of 625 dpm/100 cm². The contaminated area was roped off until decontaminated. Bioassay was collected from personnel working in the area though no intakes were detected (HP Monthly Reports, 1959-1960).
- Floor and Equipment Contamination, August 1960: The floor in the MTR Metallurgical Lab was contaminated from work with U-235. The floor was contaminated to a maximum of 110 dpm/100 cm² while equipment was contaminated to a maximum of 56,000 dpm/100 cm². Bioassay was collected from personnel working in the area. As a result of that incident, Health Physics required anti-contamination clothing when doing similar work in the MTR Metallurgical Lab (HP Monthly Reports, 1959-1960).
- Leaking Plutonium Capsule, [location acronym redacted], June 1961: A capsule containing plutonium leaked in the [location acronym redacted] contaminating a small area of the facility to an average smear of 5,600 dpm/100 cm². All personnel involved were surveyed and found to be free of contamination except one worker. The worker was sent to the CFA dispensary for decontamination. Bioassay samples were collected from personnel involved in the incident. The results showed no detectable alpha activity (Johnson, 1961).
- Contaminated Capsule Holders, RMF, July 1961: Capsule holders used at RMF became contaminated up to 100,000 dpm plutonium. The holders were taken to the Health Physics office at TRA. The HP office was subsequently contaminated along with RMF and HP staff, with [number of people redacted] [body part redacted] becoming highly contaminated. Contaminated areas and staff were easily decontaminated with the exception of [number of people redacted] [body part redacted]. That [number of people redacted] [body part redacted] was successfully decontaminated after several decontamination iterations over the day. Urine samples were collected by all personnel involved and showed no detectable plutonium (Johnson, 1961).

- Plutonium Contamination, Wide Area of TRA, November 1963: Widespread alpha contamination was discovered on the evening shift of November 15, 1963, and subsequently through November 18, 1963 (Johnson, 1963). This widespread contamination was initially discovered during a routine radiation survey of tools brought to the MTR Health Physics office. Contamination from the same cause was found in the mock-up area in the MTR service wing, the MTR welding shop, and in a major portion of the ETR complex, ETRC, TRA maintenance building, TRA cafeteria, and on several walkways and roadways in exclusion areas. Low-level contamination was also found on personal items in eight homes and [number and ownership redacted] vehicle (Loop, 1963a).

MTR Health Physics found the original cause of the contamination was a contaminated movable welding glove box that had not been approved for work with radioactive materials nor surveyed after use. The glove box had been used in late-October in the MTR mock-up area (Loop, 1963) to weld several thin capsules containing Pu-240 for future irradiation at EBR-1. A drawing of the moveable glove box is shown in Figure 5-50. The structure and size of the capsule containers was such that they were easily breached during welding. Both maintenance and HP workers observed breaches but the glove box was not surveyed for contamination. That glove box was used for welding other materials after being contaminated. As those materials were transferred across MTR, labs, ETRC and ETR, Pu-240 contamination picked up during welding was transferred across these areas. After the contamination was detected, control measures were instituted, which included isolation of the area and contamination checks of persons, buses, and homes. Low level contamination was found in eight homes, [number redacted] automobile, and three NRTS buses, all of which were easily cleaned. Work was barred from affected areas until each was decontaminated. The welding glove box was also decontaminated. Workers were given additional training in use of safe work permits and in the shipment of radioactive materials.

Ninety-nine bioassay samples were collected from 78 workers exposed to the contamination. Sixty-eight fecal samples were collected from twenty-two workers. Both urine and fecal samples were analyzed for plutonium (Horan, 1963). The contamination was documented by INL in *Findings of Accident Review Committee Alpha Contamination Incident Test Reactor Area (TRA) November 15-18, 1963* (Latchum, 1963).

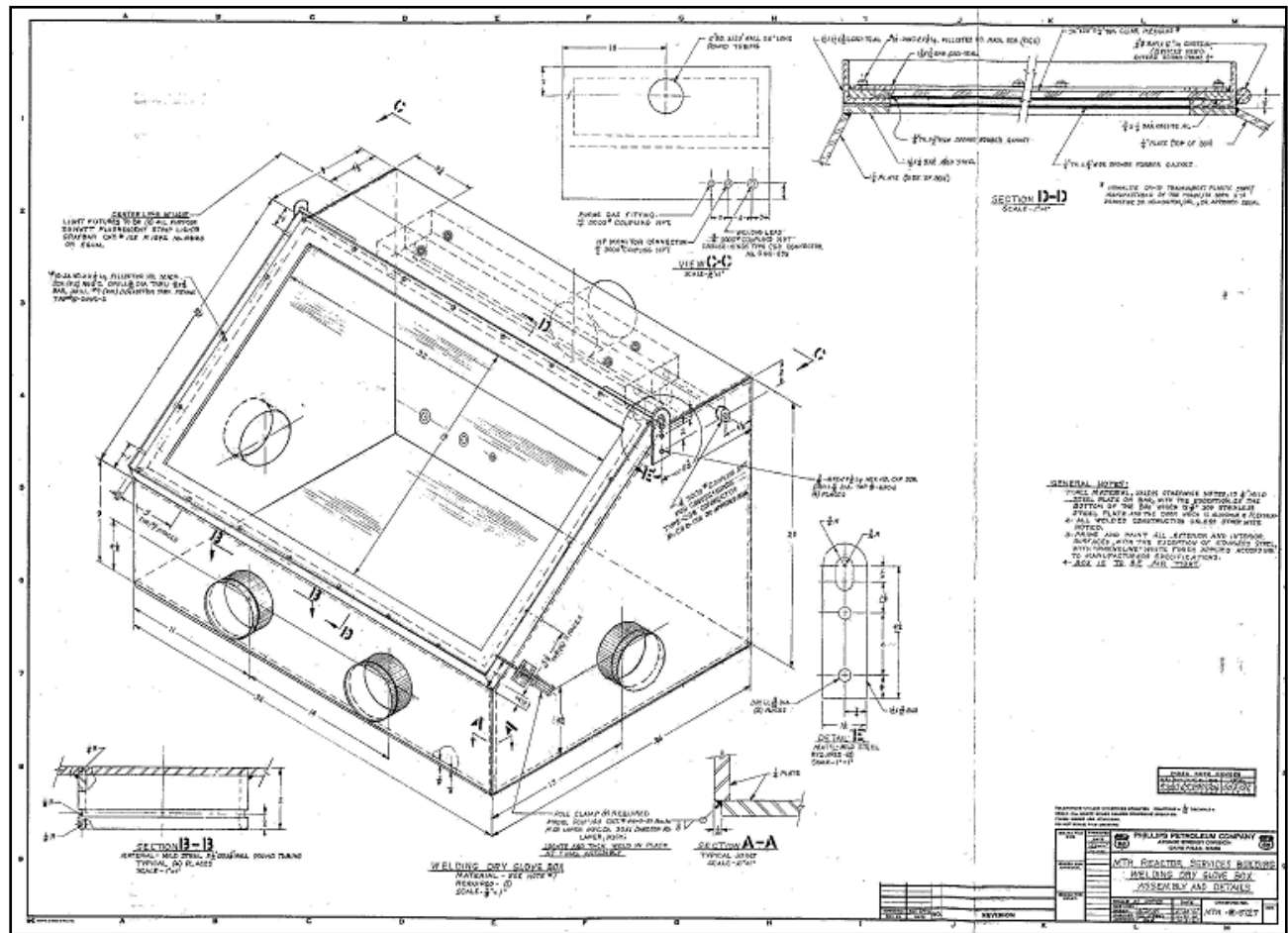

Figure 5-50: Schematic of Moveable Glove Box (Initial Cause of Pu-240 Contamination)

The Atomic Energy Commission performed a separate review of the incident (Loop, 1963) listing findings, including one of personnel exposures:

- Data from urine analyses were positive only on five persons and in all cases were sufficiently low to indicate negligible bone dose (plutonium was in the form of an insoluble oxide).
- Data from positive fecal analyses on eight individuals indicated inhalation to be sufficiently low such that maximum dose to the lungs using the established ICRP method and model of that era was less than INL's radiation protection guide.
- Contamination, MTR Alpha Lab, December 1964: Lab 126 of the MTR alpha lab extension was contaminated by an unidentified source. The low-level contamination was noted outside glove boxes, inside hoods, in a sink, and on one lab hot plate. While the activity was considered low-level, Health Physics stressed the need for more stringent contamination control by alpha labs staff (Johnson, 1965).
- Contamination, MTR Metallurgical Lab, September 1965: Low-level alpha contamination from uranium (about 3 cpm/100cm²) was discovered in the "cold met lab" at MTR following a spill. Furthermore, a [role redacted] retrieved a package from the lab, thus transferring some low-level alpha contamination to a [type redacted] vehicle. Contamination was cleaned to below detectable level in both the lab and the car. No bioassay was performed given the low-level activity (Hawley, 1965).
- Alpha Contamination, MTR, August 1967: Alpha Labs 124, 127, and 128 were contaminated from work with americium, curium and plutonium (Phoenix, 1967). Smears obtained from surveys of contaminated areas ranged as high as 100,000 dpm/100 cm². The contamination was subsequently tracked by foot to the hallways, other labs in MTR, and to the TRA cafeteria. A glove box in Alpha Lab 128 was found to be the original source of the alpha contamination. It was bagged, surveyed, and shipped to the Burial Ground. Contamination in the labs, hall, and cafeteria was cleaned. Bioassay samples were collected from lab staff exposed to the contamination with a potential for intake.
- Plutonium Air Activity, Lab 128, September 1969: Plutonium air activity was released while [number and role redacted] were transferring Pu-238 samples from a glove box to a hood. A nearby CAM alarmed with an increase of 1,000 counts per minute. An investigation showed there had been little negative pressure in the glove box. [Number and role redacted] were assessed for intakes by bioassay; none were found. A corroded exhaust line valve was replaced on the glove box (Howe, 1986).
- Americium Alpha Contamination, Lab 128, October 1969: Contamination (identified as Am-241) was spread across the lab floor after a boiling chip containing Am-241 exploded. The lab and adjacent hallway were sealed off until the areas were decontaminated. Although the [role and item redacted] were contaminated, [body part redacted] and [item redacted] were not. Follow-up bioassay was negative (Hughes, 2002).

5.4.2 Incidents at the Chemical Processing Plant

Since 1949, three events at CPP have caused workers to receive radiation doses in excess of current radiation protection standards.

- Open Transfer Valves, March 20, 1958: Eleven workers at the Idaho Chemical Processing Plant received radiation exposures during a routine transfer of radioactive waste material (including iodine-131) to permanent storage. The waste materials were being forced under steam pressure from one process cell through another process cell to a permanent storage tank. At the time, the second cell had been out of use for about eight months. Although the workers had checked the cell's process valves and thought them to be closed, the valves, in fact, were stuck partially open but gave the appearance of being closed. When the steam pressure built up, radioactive vapor was vented through the partially open valves into the work area. Although 11 workers were exposed to the radioactive vapor, only seven workers received radiation doses to their thyroids in excess of the 30 rem/year thyroid dose standard in effect in 1958. The exposures to the seven workers ranged from 30 rem to 210 rem. However, only three of the seven workers would have received doses exceeding the current thyroid dose standard of 50 rem/year (Rich, 1958).
- Criticality Accident, October 16, 1959: The accidental transfer of a uranyl nitrate solution to an unsafe storage tank resulted in a criticality event at CPP that exposed [number redacted] individuals to radiation. The liquid solution, which contained enriched uranium, was accidentally transferred from a geometrically safe storage tank to an unsafe waste collection tank through a line normally used to transfer decontaminating solutions to waste storage. The transfer occurred as a result of an inadvertent siphoning action. The siphoning action drew about 34 kilograms of enriched uranium (in solution) to the unsafe storage tank, placing the uranium in a critical configuration (Ginkel, 1959). The incident spread radioactivity throughout the building and into operating areas via vent lines and drain connections, triggering radiation alarms and prompting the evacuation of the building. Twenty-one individuals evacuated the process building and the surrounding area of high radiation. No indium foils were activated during this incident, indicating that any neutron emissions were contained by the shielding (Hayden, 1959). All individuals involved in the incident were monitored and, although seven individuals received external radiation exposures, none of the individuals received a whole body exposure that exceeded the 15 rem/year standard in effect in 1959. However, [number redacted] individuals received whole body doses of 8 rem and 6 rem, which exceed the current 5-rem whole-body exposure standard (Ginkel, 1960).
- Maintenance Incident, March 19-24, 1973: The Waste Calcination Facility was in a shutdown status for maintenance work on process equipment during the first part of 1973. Equipment failure allowing process-solution spillage had resulted in considerable contamination on the cell walls, floors, and equipment. Extensive effort had been expended in decontamination over a nine-month period, but not all of the radioactivity could be removed. Fission product ruthenium-106, resistant to decontamination methods, constituted the major radioactivity remaining in the contamination. High radiation doses to a worker in the WCF led to the initiation of a joint ACC/AEC-HSL study of problems in dosimetry and dose control at the CPP. Dosimetry results from film badges, TLDs, and direct-reading dosimeters were compared. Personnel exposure values were also compared with values from controlled experiments. The data showed a

serious inconsistency in the relationship between film badges, direct-reading dosimeters, and TLD readings.

A [role redacted] making repairs on the [location redacted] facilities at CPP received high radiation exposures. The [role redacted] was on loan to the plant to do repair work on one of the [location redacted] contaminated by ruthenium-106. Working in direct contact with the cell, the worker was exposed to high levels of high-beta energy fields. Routine film badge checks indicated that the worker, who was normally assigned to non-radiation areas, had received high exposures. The problem arose, in part, because the radiation monitoring devices (pocket dosimeter and film badge) used by the worker were calibrated for radiation fields significantly different from the fields encountered. The [role redacted] received a whole body radiation dose of 5.2 rem, which was less than the 12 rem/year exposure standard in effect in 1973, but is greater than the current 5-rem standard (Anderson, 1974, PDF p. 6).

Periodically, there have been incidents such as spills of transuranic isotopes and excursions within shielded cells. Calculated and measured personnel exposures from bioassay results were below permissible levels, but each incident re-emphasized to Health Physics and technical personnel the importance of critically-safe geometries and the potential for transuranic exposure at the CPP. Selected examples of the incidents are listed below.

- Release of Contaminated Air in Z-Cell, January 24, 1958: Contaminated air was released in Z-Cell that resulted in exposures to [number redacted] personnel. The contamination was caused by excessive air flow in Z-Cell equipment that caused uranium-contaminated fumes to be expelled from the cell floor sump jet line. As soon as the vapors were noticed, air samples measuring 2×10^{-6} $\mu\text{Ci/mL}$ were taken near the line and respirators were worn by all personnel entering the cell. Urine samples were taken from the [number redacted] men and the [role redacted], and nasal swabs were collected from the [number redacted] men involved. No contamination was detected on the nasal swabs and the highest urine concentration was 14.8×10^{-5} grams U/L (Sommers, 1957a).
- Plutonium Contamination Encountered, July 1959: During the modification of the waste amsco storage and transfer system in the access corridor, plutonium-contaminated solution was encountered. Although the actual Pu concentration was lower in this case than some average plant streams, the Pu was present as a major fraction of the total activity (approximately 50%). At the time, the seven personnel involved in this incident were equipped with protective clothing (including respirators); hence, no significant internal exposure was incurred. This was confirmed by the results of 24-hour urine specimens submitted by each of the seven individuals and analyzed for Pu; the results were negligible (Progress Reports, 1959, PDF p. 6). The areas, which were Pu-contaminated (i.e., access corridor and solvent burner), were isolated and tagged until decontamination was accomplished. Incident investigation suggested that the most probable source of the Pu concentration was the interface of the CPM first-cycle extraction columns, which had undergone some experimental flow-sheet changes during the previous processing run. No significant alpha-fallout activity was detected within the plant area, except for the immediate solvent burner area (Hayden, 1959a).

- Plutonium Activity from Burning Solvent, August 1959: An attempt was made during the month to burn the Pu-contaminated solvent from first-cycle extraction columns accumulated during the past plant run. After 12 hours of burning, Health Physics requested that this operation be discontinued because activity was approaching an unsafe limit in the burning area. The solvent was later decontaminated and burning was continued without further incident (Hayden, 1959b).
- Criticality Incident in H-Cell, January 1961: A build-up of air pressure in the H-Cell decontamination lines lifted a concentrated solution of enriched uranyl nitrate from a geometrically-safe section of a first-cycle product evaporator to a critically-unsafe section of the evaporator. Of the 251 individuals present in the CPP area at the time of the incident, none received a significant radiation exposure. The highest exposure, as determined from film badge readings, did not exceed 55 mrem of penetrating radiation. Essentially, no beta radiation was detected. No significant neutron exposures were registered by the network of activation foils in the access corridor. No evidence of internal contamination from inhalation was found. The absence of significant exposures is attributable to the extensive shielding provided by the process cell in which the event took place, and to the control of the fission gases by the equipment (Paulus, undated).
- Alpha-Contaminated Smear Samples, November 12, 1972: Routine health physics smear surveys of the Mass Spectrometry Laboratory (CPP-602, Labs 212 and 216) revealed low-level alpha contamination. The contamination on the high-level surfaces with predominant downward air flow indicated a strong possibility of significant air concentration. There were no air samplers in operation at the time. Therefore, whole-body counting, fecal, and urine analyses were performed for the individuals involved. On November 9 and 10, neptunium-plutonium samples prepared as nitrates contained about 0.5 g/l of neptunium and about 0.07 g/l of total plutonium, with the following mass percentages of plutonium isotopes: Pu-238, 5 w%; Pu-239, 80 w%; Pu-240, 10 w%; Pu-241, 2 w%; and Pu-242, 1/2 w%. The activity of each sample was estimated at about 30 μCi . These samples were normally in the range of 6-10 μCi . The neptunium was separated from the plutonium fraction by wet-chemical means within an alpha-tight glove box located in X-cell.

Minor internal plutonium contamination of thirteen analytical laboratory personnel occurred during what should have been a routine sample-preparation procedure. A contributory cause was an abnormally-high quantity of plutonium in one sample. Resulting lung doses were small fractions (less than 2%) of the AEC guidelines, but the intensive bioassay-sampling program employed revealed an apparent previous plutonium exposure to [number of people redacted] of approximately one-third of the maximum-permissible lung burden for Pu-239 (Wenzel, 1973). It was determined that this earlier exposure occurred around May 1, 1972, during the clean-up of X-Cell (Wenzel, 1973b). NIOSH review of this earlier exposure indicates that the activities conducted in X-Cell were documented in Health Physics log books, along with survey results indicating significant alpha contamination within the cell (HP Log Sheets, 1972). However, the log books do not indicate that these activities prompted a special bioassay. Because the [number of people redacted] exposed in this case was not a frequent occupier of X-Cell, [number of people redacted] would not have been included in the routine sampling program for this area (Stroschein, 1967)

Another Pu-238 filament was run on November 17, 1972, and at the end of the day, the carton containing the used filaments was prepared for disposal. While performing this operation, the bottom fell out of the container, dropping the filaments tested that day onto the floor. HP was called, the filaments picked up, and the floor wiped up. Smear surveys subsequent to the clean-up still read 500 cpm; the local area was isolated and cleaned up on November 20, the following Monday (Malmstrom, 1972).

Health Physics procedures in place at the time of the incident (dated November 1968) specified that Labs 212-216 were to be smear-surveyed weekly. Review of Health Physics records revealed that, for the first seven months of 1972, the laboratories were smeared an average of once per week. Since August 1972, the frequency of the routine smear surveys was about once every three weeks, with intervals of up to six weeks between surveys (Malmstrom, 1972).

As a result of these findings, NIOSH has determined that it cannot demonstrate that all

- Alpha Spill in S-Cell, February 1973: There was an alpha spill behind the S-Cell instrument panel. No detectable personnel exposures were recorded (Condotta, 1981).
- Plutonium Spill in Y-Cell, November, 1973: Detectable personnel exposures were below maximum permissible dose (Condotta, 1981).
- Plutonium Spill in Access Corridor, January 1974: No significant personnel exposures recorded (Condotta, 1981).
- Spill of Sample from Neptunium Recovery Process, September, 1974: The sample spill occurred in CPP-602, Rooms 204, 207, and 209. No detectable personnel exposures recorded (Condotta, 1981).
- Plutonium Spill in CPP-602, February 1975: A plutonium spill occurred in CPP-602, Room 703. No detectable personnel exposures (Condotta, 1981).

5.4.3 Incidents at Test Area North

- Uranium Contamination Found in TAN-615, March 1963: In March 1963, TAN-615 was handed over to the Phillips Petroleum Company (Phillips), which had the STEP contract. Upon turnover, Phillips performed a thorough inspection and unexpectedly found the entire building to be highly contaminated with alpha radioactivity (TAN HP Report, Dec1963, PDF pp. 45-49). The alpha radioactivity was later determined to be from uranium (Dierks, 1963).
- Alpha Contamination Found in Fuel Storage Vaults of TAN-607 Building, February, 1963: In February 1963, the Fuel Storage Vaults in TAN-607 were found to be “contaminated to a fairly high level with alpha contamination” and were decontaminated during that same month (TAN HP Report, Dec1963, PDF pp. 50-54). The spot with the highest contamination was in the bottom of a file cabinet drawer that was full of coffee grounds (TAN HP Report, Dec1963, PDF pp. 50-54).

Given that only uranium-based fuels were used in the TAN reactors, the alpha contamination in the Fuel Storage Vaults was likely limited to uranium contamination.

5.4.4 Incidents at the Misc. Reactor Areas

- Stationary Low-Power Reactor #1 (SL-1) Reactor Explosion, January 3, 1961: A three-member military operating crew was involved in a nuclear incident at SL-1, a prototype nuclear power plant designed to provide power and heat for remote military installations. During reactor maintenance, one member of the military crew withdrew the central control rod well beyond the limit specified in the maintenance procedure. This resulted in a release of nuclear energy and the rapid formation of steam in the pressure vessel, accelerating a column of water above the core and slamming it into the pressure vessel. The impact of the compressed water sheared the connecting piping, lifted the vessel into the air, and contaminated the reactor building. Although the reactor building confined most of the radioactive material, about 1,100 curies of radioactive material were released into the atmosphere. This external release, according to the DOE historical dose evaluation study, did not expose the public to radiation above the current standard. All three members of the military crew were killed by the force of the reactor explosion or by injuries related to the explosion. Two were killed in the blast itself, and the third died two hours later from a head injury. In addition, 22 individuals subsequently involved in retrieving the bodies and cleaning up the site received radiation exposures ranging from 3 to 27 rem. A total of nine individuals received radiation doses exceeding the 15-rem standard in effect in 1961. However, 14 individuals received radiation doses that exceeded the current 5-rem standard (SL-1 IDO Report, 1962).

An extensive personnel monitoring program was implemented immediately following the SL-1 accident and continued throughout the recovery effort. A single entry point was established to ensure that the required personal protective equipment was used, that film badges were worn, and that briefings were provided to minimize work time in high-radiation and contamination areas. On January 5, 1961, IDO Personnel Metering Branch began issuing a daily report that listed worker names, dates, and amounts of radiation exposure attributable to the SL-1 incident (IDO Report, 1961). Personnel Exposure Questionnaires (badge reports) were established for those initially involved in the incident response. These reports were used when an employee's exposure reached a total of 1000 mR or more during the month (SL-1 Records, 2009). Examples of Health Physics Data reports, which include personnel exposures and information about the number of entries into SL-1, are available (Hoover, 1961; Layfield, 1961).

Following the incident, personnel were exposed to airborne radioactive particles. Spot urine samples were collected from 110 individuals during the first few days after the incident (IDO Report, 1961). Thyroid counting was also implemented because I-131 was the major fission product of concern. All personnel involved in the SL-1 recovery effort submitted urine samples monthly or as needed based on radiological conditions. All samples were processed by the IDO Health and Safety Division. Urine samples were placed in a deep-well scintillation counter and gamma-counted. Gamma spectra indicated that essentially all of the radioactive material in the urine was I-131. Samples with statistically-significant activity underwent radiochemical separation and were beta-counted. Eight workers had urinary excretion of Sr-90 beyond Day 10 post-exposure and started 24-hour urine samples to establish urinary excretion curves. Repeated samples were taken as needed and whole-body counts were done on all individuals with positive

gamma results (SL-1 Final, 1962). Six persons involved in the SL-1 incident reported to whole-body counting during the first week following the incident. Identification of I-131, Ba-140/La-140, and Cs-137 was made by gamma spectra from all six of these workers (IDO Report, 1961).

5.4.5 Incidents at Central Facilities Area

- For the purpose of this SEC evaluation report, there were no significant incidents to report at the Central Facilities Area.

5.4.6 Incidents at the Burial Ground

- “Chinook” Flood Event at the Burial Ground, February 1962: Heavy rainfall on top of existing snow caused a water run-off event from the surrounding area into the Burial Ground. Pits 2 and 3, as well as Trenches 24 and 25, were open at the time and filled with water. Breakage of some waste boxes allowed contaminated items such as gloves and bottles to be distributed in undeveloped areas adjacent to the Burial Ground. All detectable contamination was confined to the local areas. The event did initiate the installation of a diversion drain system around the perimeter of the Burial Ground (RWMC History, 1979).
- Fires in Burial Ground Trench 42, September 1966: On September 8 and 9, 1966, fires originated from waste buried in cardboard boxes. The cause of the fires was an inadvertent inclusion of alkali metals with low-level waste. The AEC-ID Fire Department extinguished the fires with water and by bulldozing soil over the items. Neither property damage nor detectable spread of contamination resulted from the event. During that time, it was decided to increase the minimum soil cover of buried waste from 0.6 to 0.9 meters and to increase the minimum trench depth from 0.9 to 1.5 meters (RWMC History, 1985).
- Flood at Burial Ground, January 1969: During a two-day thaw, rainfall combined with melting snow flooded the Burial Ground. The flooding of Pits 9 and 10 as well as Trenches 48 and 49 was partially caused by large snow drifts that blocked the drainage system installed after the 1962 “Chinook” flood. The water runoff overflowed the old dikes and flowed into the Burial Ground. As a result of the 1969 flood, new dikes and ditches were installed so that heavy equipment could be used to clear snow drifts. No significant spread of contamination resulted from this flood event (RWMC History, 1979).
- Fire at Burial Ground Temporary Storage, June 1970: A fire, started by sunlight shining on a black drum containing depleted uranium turnings and a loose lid, was discovered by security personnel at an above-ground temporary storage location. Initial attempts to extinguish the fire by the Fire Department were unsuccessful. An equipment operator used a crane to isolate the drum so that a bulldozer could cover the drum with soil to extinguish the fire. Air and direct radiation readings were constantly monitored with “very low” contamination reported (Fire, 1970).

6.0 Summary of Available Monitoring Data for the Class Evaluated by NIOSH

Comprehensiveness of Individual INL Monitoring Data Received from DOE

When an individual who worked at INL files a claim under EEOICPA, the DOE responds with monitoring data for that individual. With one exception, NIOSH has not seen any indication that the DOE responses do not include all of an INL worker's internal and external dosimetry records. In 2012, personnel from the INL's EEOICPA office made NIOSH aware that, in the past (period currently undefined), monitored visitors with no positive external doses and no bioassay data would not be entered into the INL's dosimetry system, and the DOE responses received by NIOSH would not contain the external dosimetry records for those visitors. NIOSH was also informed that the INL site *does* have the external dosimetry records for those visitors; however, they are not in a readily-retrievable format for EEOICPA claims. Because the measured external doses for those visitors were all zero or less than their limit of detection, their missed external doses can be bounded by assuming the maximum dosimeter exchange frequency for a given year of monitored employment. This is not an issue when a worker has bioassay data because all workers with bioassay data were entered into the INL's dosimetry program.

Comprehensiveness of INL Reports Received from DOE

NIOSH has not been able to verify that DOE responses provide all of the incident reports for workers involved with incidents. Incident reports provide useful information, such as intake date and source term data that aid in producing more accurate dose reconstructions. Incident information is periodically received in the DOE responses for INL claims; however, in 2014 and 2015, NIOSH captured a significant amount of incident records from the INL site and Seattle-NARA (National Archives and Records Administration). These records are being added to ORAUT's Site Research Database (SRDB) and are being coded so that the names of the personnel identified in those reports will be linked to the EEOICPA claim as a "Personnel Exposure" file. NIOSH will continue to investigate, on a case-by-case basis, situations in which DOE responses for claims may be missing incident report information (based on the holdings in the SRDB).

The following subsections provide an overview of the state of the available internal and external monitoring data for the INL class under evaluation.

6.1 Available INL Internal Monitoring Data

The Health and Safety Division of AEC's Idaho Operations furnished a comprehensive personnel metering program for radiation monitoring of all NRTS personnel. The Analysis Branch of the division initially provided routine urinalysis of all NRTS personnel with sampling frequency varying between quarterly and yearly, depending on the expected potential for uptake (Horan, 1959). At the discretion of the chief health physicist of an individual program, the sampling frequency could be increased based on a perceived risk of uptake potential. For example, in the early 1960s, monthly 24-hour urine samples were collected from all personnel who frequented X-Cell in CPP, including the HP technician. These samples were routinely processed for gross alpha, beta, gamma, and plutonium.

Any radioactivity detected by gross analysis was identified, and additional samples were requested when it was thought to be necessary (Stroschein, 1967).

Historically, INL did not routinely collect bioassay samples for uranium exposures although they could equate gross beta urinalysis results to uranium intake using an activity-to-mass conversion if there was a known uranium release; NIOSH has not found evidence of any such incident. INL controlled exposure to airborne uranium by use of continuous alpha and beta air monitoring. INL also used radiation survey smear data as an indication of uranium releases (Personal Communication, 2014i); if an indication was found, bioassay samples would be collected from affected workers.

INL did not routinely monitor workers for internal exposures to thorium. INL controlled exposure to airborne uranium by use of continuous alpha and beta air monitoring. INL also used radiation survey smear data as an indication of thorium releases (Personal Communication, 2014i); if an indication was found, bioassay samples would be collected from affected workers. Workers with potential for Pa-233 intakes were monitored using urinalysis and whole-body counting.

Site-wide routine samples were initially analyzed only for gross alpha and beta, with isotopic analysis performed only if activity was discovered in the sample, although capabilities existed for analyses of specific isotopes, such as Pu-239, Sr-90, Co-60, and I-131 in body excreta, water, and air samples. The Analysis Branch also made analyses for materials related to good industrial hygiene practices, such as beryllium, lead, mercury, arsenic, fluorine, or any other chemical that may have been required (Horan, 1959). Beginning in May 1957, the Health and Safety Division started requesting gross-gamma counts on all urine samples submitted by CPP personnel in an effort to detect the potential uptake of iodine from fresh fuel (HP Monthly Reports, 1957). Table 6-1 provides INL *in vitro* measurements for 1953-1975.

Based on the loss of iodine due to volatilization during the wet-ashing process, as well as the small likelihood of a significant uptake of a pure beta-emitter without a correspondingly-large uptake of gamma-emitting fission products, the gross-beta procedure on urine samples was discontinued entirely in December 1960. However, in order to detect a slow build-up of the bone-seeking, beta-emitting strontium isotopes from low-level sources over long periods of time, specific strontium analyses were made for each individual that had worked in a reactor or chemical processing area for two years or longer (Murphy, 1966) every two years and on termination of employment (Horan, 1961).

Table 6-1: *In-Vitro* Measurements for INL, 1953-1975

Year	Gross Alpha	Gross Beta or Beta/Gamma	Gross Gamma	Cs	Sr-89 / Sr-90	U-233 / 234 / 235 / 238	Pu-238 / 239 / 240	Total Urine ^(a)	Total Fecal
1953	-	455	-	-	-	1	-	456	-
1954	6	1400	2	-	-	52	-	1466	-
1955	-	2774	1	-	-	42	3	2896	-
1956	6	4924	1	-	89	17	-	5054	-
1957	-	7572	242	1	1	95	2	9798	-
1958	1	7398	240	-	4	133	3	10719	-
1959	1	7010	1048	-	37	57	21	9682	-
1960	-	6213	1794	-	69	40	9	8932	-
1961	-	40	7006	39	2096	2	8	9219	27
1962	8	8	6125	2	1579	13	18	7775	-
1963	-	19	5890	-	937	124	135	7275	75
1964	1	2	5401	-	2228	60	40	7763	33
1965	-	10	5610	3	1079	50	58	6871	6
1966	1	-	1823	-	1099	11	11	2956	3
1967	-	20	414	-	395	17	31	851	42
1968	-	447	302	-	328	-	15	1138	-
1969	-	148	581	2	182	1	19	940	-
1970	1	5	189	1	10	18	6	274	-
1971	-	-	3	-	-	-	-	5	-
1972	-	-	-	-	-	-	29	58	335
1973	-	-	-	-	-	-	58	58	103
1974	-	-	1	12	13	-	35	76	81
1975	-	22	7	5	38	-	8	80	171

Source: Bioassay, 1956-1984; Bioassay, 1956-1967; Bioassay, 1958-1986

^a Total number of urine samples includes infrequently-sampled radionuclides not included in this table, such as H-3, Co-60, and others.

Whole-body counting (WBC) was started at NRTS in January 1961. The convenience, sensitivity, and reliability of whole-body counting made it the choice of personnel monitors for internal radioactivity from gamma-emitting nuclides. Consequently, urinalysis as a routine monitoring technique was abandoned by the laboratory. From that time, urine was analyzed only for iodine, uranium, and strontium or for elimination studies on specific isotopes (Voelz, 1970). Early in the site's history, job duties and their corresponding exposure potentials were used to place employees into the following routine WBC frequencies: quarterly, yearly, or no count needed. Special analyses were requested by the relevant Health Physics sections when internal exposure was suspected due to events occurring in a plant; terminations that required a physical examination, as determined by the relevant Health & Safety sections, also required a whole-body count (McCaslin, 1963).

A portable, unshielded whole-body counter was developed and constructed in 1963. NOTE: This counter was used to monitor people involved in an incident that occurred when a shipment of methyl iodide released activity in an airplane. A medical van containing a whole-body counter was designed and purchased in 1965. Near the end of 1966, policy shifted to performing routine WBCs on employees once every four years, while maintaining the requirement to perform special analyses on

those involved in radiological incidents (McCaslin, 1966). By 1969, whole-body counting equipment available at the Analytical Chemistry Branch Laboratory included rotational counting, helical scanning, and a detector for determining Sr-90 in the skeleton by counting the Bremsstrahlung emission from the skull (Voelz, 1970). Table 6-2 provides INL *in vivo* measurements for 1961-1975.

Year	Number of Results
1961	1344
1962	2667
1963	3839
1964	1998
1965	2646
1966	3072
1967	1511
1968	1534
1969	1158
1970	1350
1971	1210
1972	1396
1973	1285
1974	794
1975	1626

Source: Bioassay, 1956-1984; Bioassay, 1956-1967; Bioassay, 1958-1986

In May 1967, the Health Services Laboratory was organized from six branches of the Idaho Operations' Health and Safety Division. Its primary function was to develop a technical staff in occupational medicine, health physics, radiological dosimetry, analytical chemistry, and instrumentation to support the NRTS occupational health programs (Voelz, 1969).

Although the analyses were performed at the HSL Analytical Chemistry Branch, over time, the requirements for determining which employees would be sampled and on what frequency became fragmented by department and facility. By 1974, bioassay samples were collected and analyzed only when an exposure incident was suspected. The typical problems were encountered in obtaining the cooperation necessary from exposed personnel (e.g., providing samples as requested and furnishing all necessary information). A routine program existed at that time for WBC measurements of CPP personnel for gamma-emitter uptake. Each individual working at CPP received a whole-body count every four years (i.e., 25 percent of the work force was counted every year). The majority of the counting was done using the HSL mobile WBC (NaI detector) that was brought to the CPP. The remaining counting was accomplished using the WBC facilities at the HSL (Rich, 1974).

Also during 1974, a routine bioassay program was being developed. The proposed program recommended the collection and analysis of about 350 bioassay samples per year. Of these, 50 were to be fecal samples to be analyzed for plutonium and/or uranium, 50 were to be urine samples to be analyzed for plutonium, and the remaining 250 were to be urine samples to be analyzed for total

uranium and fission products. The challenge at the time was that the HSL staff level was not sufficient to provide for this increase in routine bioassay sampling (Rich, 1974).

Surveys, air samples, and bioassay samples for fission and activation products (via gross alpha and gross beta/gamma analysis) were routinely performed over the entire period under evaluation, as indicated by many available documents and a database (Bioassay, 1956-1984; Bioassay, 1956-1967). Workers were routinely assayed, by either urinalysis or whole-body counts, for potential intakes of fission and activation products and for alpha-emitting radionuclides (including but not limited to plutonium) when alpha contamination or air monitoring data exceeded background, or after the occurrence of an incident involving the airborne release of radioactive material, or when alpha contamination or air monitoring data exceeded background.

Examples of radiological survey data can be found in the following examples: Survey, Jun1958; Survey, Nov1958; Survey, Oct1955; Survey, May-Jun1955; Survey, Aug-Dec1953; Survey, Apr1963; Survey, Aug1968; Survey, Jul1963; Survey, Apr1969.

Details regarding the various analyses used and the associated minimum detectable activities are presented in the Technical Basis Document, *Idaho National Laboratory and Argonne National Laboratory-West - Occupational Internal Dose* (ORAUT-TKBS-0007-5).

6.2 Available INL External Monitoring Data

Personal dosimeter data (i.e., film badge and/or TLD) are the primary data type used to reconstruct the external doses for INL workers. Those data are specifically used to reconstruct a worker's measured and missed external doses. For the period under evaluation for this report, the INL site monitored all workers for external photon and beta (electron) doses via their own dosimeters when inside the major radiological operating areas (Cipperley, 1958; CPP HP Manual, 1952; Cipperley, 1968; ORAUT-TKBS-0007-6). The only known exception to this was for some construction workers. For some construction activities, parts of an operational area were fenced off and the construction workers inside those fenced areas were monitored by group dosimeters or area dosimeters. NIOSH does not possess a complete set of the INL's dosimeter data; however, the DOE does have a complete set and provides the external dosimetry records for each energy employee who files an EEOICPA claim. A summary of the dosimetry data is provided in Table 6-3.

Examples of survey data have been located but are not complete for all locations for all time periods (Survey, Jun1958; Survey, Nov1958; Survey, Oct1955; Survey, May-Jun1955; Survey, Aug-Dec1953; Survey, Apr1963; Survey, Aug1968; Survey, Jul1963; Survey, Apr1969).

Table 6-3: Historic External Radiation Exposure Distribution for INL ^a								
Year	Dose Groupings (rem) ^b						Total Monitored ^c	Site Population ^b
	0-1	1-2	2-3	3-4	4-5	>5		
1949	NA	NA	NA	NA	NA	NA	NA	NA
1950	NA	NA	NA	NA	NA	NA	NA	NA
1951	NA	NA	NA	NA	NA	NA	NA	2,250
1952	83	0	0	0	0	0	83	2,350
1953	738	34	3	2	2	1	780	2,175
1954	797	79	26	8	1	2	913	2,525
1955	1,336	120	76	29	10	4	1,575	3,025
1956	964	125	61	24	9	11	1,194	3,625
1957	1,243	114	20	4	0	0	1,381	4,550
1958	2,785	260	143	47	24	29	3,288	5,000
1959	2,962	257	196	33	14	5	3,467	5,075
1960	4,020	220	94	51	11	1	4,397	5,200
1961	3,199	346	201	138	45	19	3,948	4,920
1962	3,137	229	102	73	49	23	3,613	4,755
1963	3,283	212	87	77	23	0	3,682	5,310
1964	2,433	190	115	82	15	0	2,835	5,900
1965	2,547	439	221	180	144	61	3,592	6,025
1966	2,400	206	105	83	44	0	2,838	5,800
1967	2,502	226	109	95	53	0	2,985	5,825
1968	2,612	163	100	86	44	1	3,006	5,850
1969	2,526	196	81	70	23	0	2,896	5,850
1970	2,936	0	168	77	59	33	3,273	5,755
1971	2,723	136	57	27	4	0	2,947	5,680
1972	2,553	171	89	59	19	0	2,891	5,875
1973	2,143	183	66	36	18	1	2,447	5,975
1974	2,774	133	62	20	1	0	2,990	5,950
1975	2,399	115	51	15	0	0	2,580	3,643

Source: Exposure History, 1993, PDF p. 41

Notes:

NA = Not available

- a - The numbers presented in this table are inclusive of AEC and contractor personnel engaged only on contracts administered by IDO; they do not include visitors or personnel employed on contracts administered by other AEC operations offices.
- b - Not all of these numbers are consistent with the numbers reported in other references, such as the available Health & Safety Annual Reports (Horan, 1961, PDF p. 31; Horan, 1962, PDF p. 62). After reviewing the available INL documentation, NIOSH has concluded that definitive historical site population numbers are elusive. There is no consistent source of employment information and the various sources count employees differently. INL's own historical overview of site exposure history points out that there is little evidence of real effort to identify and preserve historic data. Those INL authors experienced considerable difficulty obtaining total counts before 1974, much less a breakdown by individual contractor (Exposure History, 1993). Most sources count only the AEC and contractor personnel administered by IDO; others may count non-IDO contract employees (e.g., ANL-W), and sometimes visitors are counted. These counts do not appear to include workers employed by minor subcontractors (e.g., construction workers), which only appear to be included when visitors are counted. Counting visitors can greatly expand the population count (e.g., for 1961, from 4,920 to 25,580) (Horan, 1962, PDF p. 61). Thus, INL employment figures are best viewed as "ballpark" numbers that reflect AEC and primary contractor personnel.
- c - These numbers are the sums from the dose groupings for a given year. In addition, they do not include visitors or personnel employed on contracts administered by other AEC operations offices, which could be significant (see Note b above).

Because all the workers in INL's radiological areas were monitored for external dose, and because the DOE provides each worker's dosimeter data for NIOSH dose reconstruction, the only doses that need to be assigned for the unmonitored workers at INL are onsite ambient (environmental) external doses. Because the control dosimeters at INL were likely exposed to elevated levels of onsite ambient radiation due to being located at the entrances of the major operating areas, onsite ambient doses are also assigned to all monitored INL workers to account for any radiation dose that may have been inappropriately subtracted from their dosimeter results as background radiation (ORAUT-TKBS-0007-6).

For the period under evaluation for this report, NIOSH has environmental dosimeter data for 1973 and beyond. The environmental dosimeters associated with those data were located along the security fence lines for each major operating area. Because the closest that an unmonitored worker could get to a major operating area was the security fence lines for those areas, the onsite ambient doses at those fence lines are considered to be bounding doses for unmonitored workers. A summary of the annual environmental doses for each major operating area is provided in ORAUT-TKBS-0007-4, Table 4-13. For the years prior to 1973, the highest 6-month value from April 1972 to April 1973 for an operating area was multiplied by two and applied to each year between 1952 and 1972. A more detailed discussion of the onsite ambient doses used for INL dose reconstructions can be found in of ORAUT-TKBS-0007-4, Section 4.3.1. For the years 1949–1951, the onsite ambient doses can be bounded by assigning the onsite ambient doses being assigned for the years 1952–1972 because radiological operations prior to 1952 were minimal compared to 1952 and later (ORAUT-TKBS-0007-2). To bound any onsite ambient dose when an energy employee's work location for a given year was unknown (often the case for unmonitored workers), the highest onsite ambient dose for any operating area can be assigned for that year.

Occupational medical doses for INL workers can be assessed based on X-ray records when provided for the EEOICPA claim, which is now common for new INL claims. When occupational X-ray records are not available for an INL worker, the occupational medical doses can be estimated using the site-specific information about the examination frequencies and types of exposures in ORAUT-TKBS-0007-3. ORAUT-TKBS-0007-3 also provides the organ doses for the X-ray procedures that were performed at INL.

6.3 Available Radiological Monitoring Data

Consideration of personnel exposures to radioactive material commenced before the start of radiological operations at Idaho National Laboratory. INL took advantage of the practices and experiences of other AEC facilities established earlier, such as Oak Ridge National Laboratory and Hanford, to establish their health physics program. AEC-IDO policy regarding health physics responsibilities and services at INL was established in 1952 creating centralized services (Johnston, 1952). INL used air sampling and radiological contamination monitoring programs as qualitative indicators of internal exposures, with routine bioassay programs serving as verification programs that internal exposures had not occurred.

The contamination control limits for the detection and control of released activity beyond the control boundaries related to instrumentation capabilities and the basic philosophy of acceptance of detectable contamination. The contamination control limits for on-plant surfaces, and particularly personnel, were always close to the MDA, so that any detectable contamination was a signal for follow-up evaluations and actions.

The monitoring of radioactivity in the air in occupied areas was a fundamental component of the internal exposure control program. Beta/gamma CAMs were used from the beginning of all facility and program operations in routinely-occupied areas. The CAM systems provided real-time air-activity evaluations while fixed air samplers provided retrospective data and an average air concentration in an area or building.

6.3.1 Available Radiological Monitoring Data for TRA

From the onset of radiological operations through the end of evaluation period, TRA Health Physics conducted routine continuous air sampling at MTR, ETR, and other areas with the potential for release of airborne radioactivity. Air monitoring checked for fission products and alpha releases. CAM filters were counted for long-lived beta-gamma and alpha activities later after collection (CAM, 1961). NIOSH has collected a sampling of TRA air sampling data; data for all the years under evaluation are available at INL. A comprehensive radiological survey program existed at TRA. Figure 6-1 shows an example radiation survey (ETR Surveys, 1961-1962); Figure 6-2 shows an example smear survey (Plutonium in Feces, 1965).

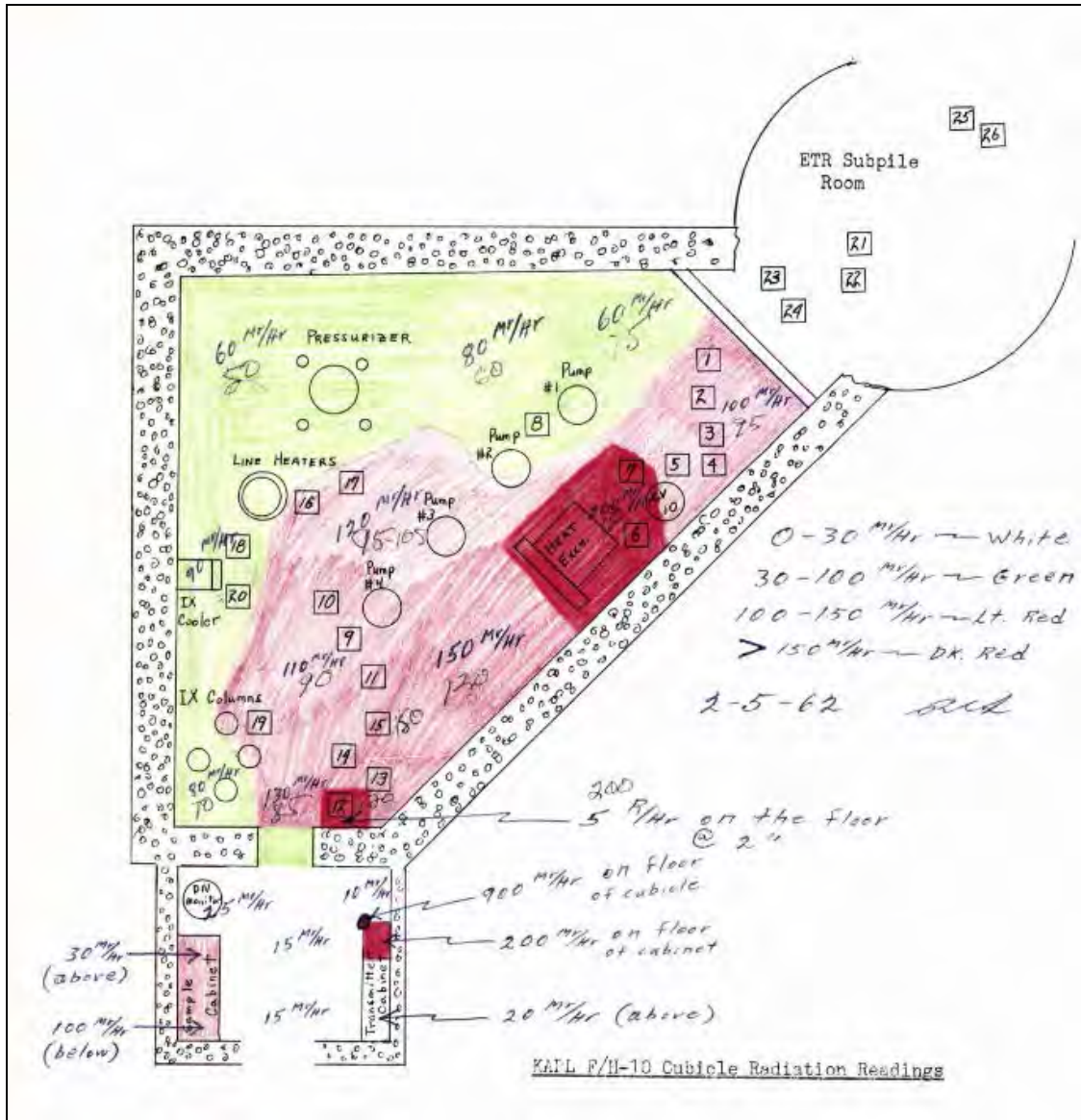

Figure 6-1: Radiation Survey of KAPL F/H-10 Cubicle in ETR, 4/24/64

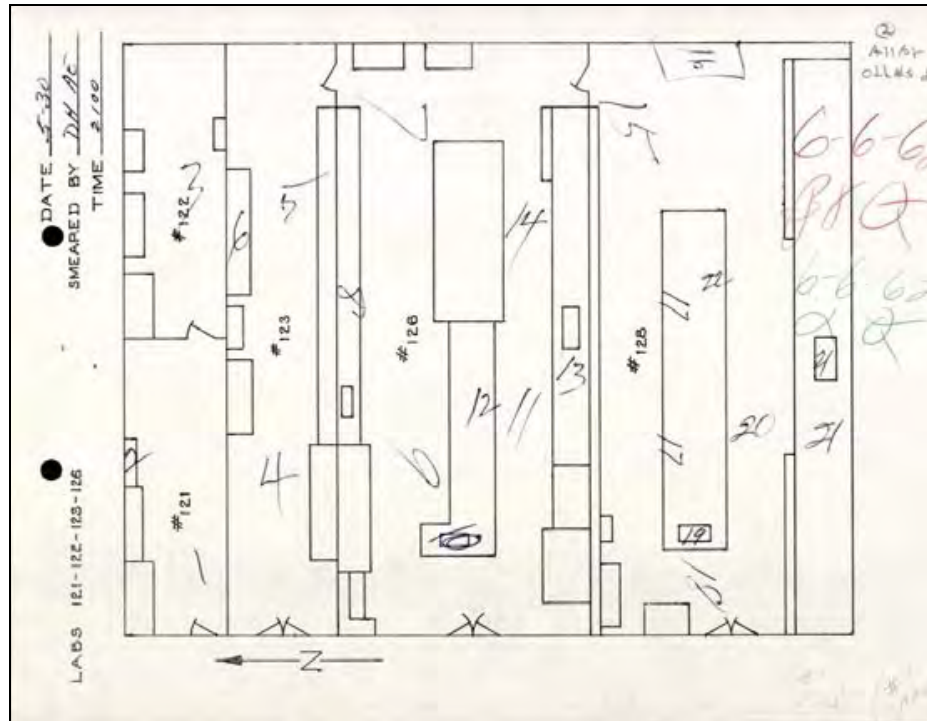
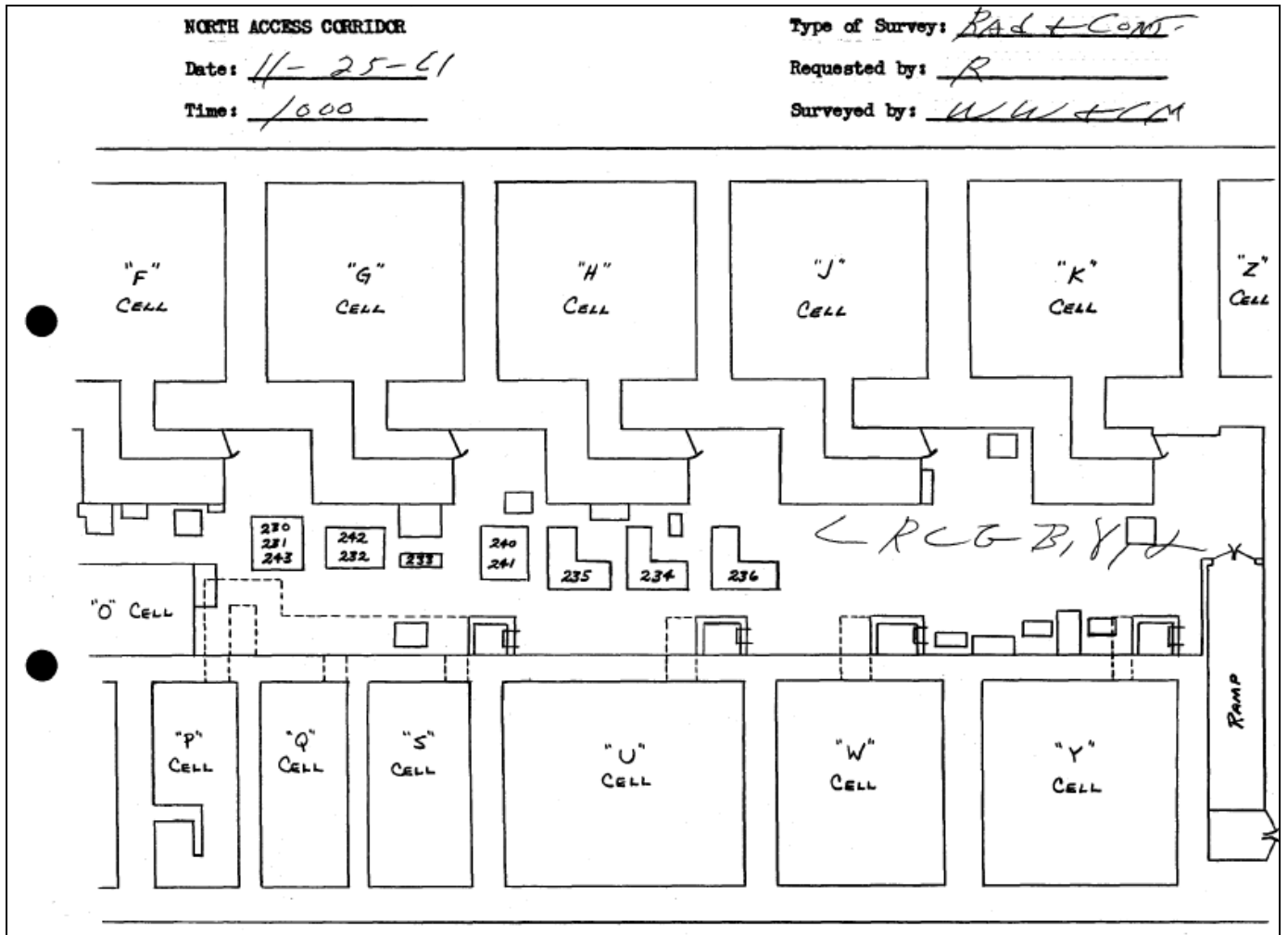

Figure 6-2: Radiological Survey of MTR Alpha Labs June 6, 1962

6.3.2 Available Radiological Monitoring Data for CPP

A review of survey and monitoring data from 1955-1971 suggests a changing attitude toward contamination control. While contamination in the CPP-601 Access Corridor was noted on survey logs in the early years of operation, routine operations required that contaminated areas be mopped to reduce the contamination level to below guidance levels. This same precedent is seen in the fluctuating contamination levels in the Operating and Sample Corridors, where one month shows contamination spread between B- and H-Cells and a survey from the following month shows no such contamination (CPP Routine HP Surveys with Alpha Results 6/29/61 – not yet in SRDB)

Contamination potential existed from each of the cells, which were highly contaminated. The greatest contamination potential existed as a result of spills, or during plant shutdown periods when the centrifuge shielding was removed or cells were entered. However, in later years, general levels in the corridors during normal operations routinely required protective clothing and contamination control barriers. The Access Corridor was contaminated routinely to several thousand dpm/100 cm² by the 1970s and the area was designated a Shoe Cover Area necessitating the wearing of protective equipment. Figures 6-3 through 6-7 successively show a comparison of contamination surveys in the CPP-601 Access Corridor area between 1961 and 1970. Note the presence of a Shoe Cover (SC) Area in the Access Corridor in Figure 6-7 (CPP HP Surveys, 1970; CPP Routine HP Surveys with Alpha Results 6/29/61 – not yet in SRDB).



Note: "RCG" in the above image refers to Radiological Control Guidelines.

Figure 6-3: Comparison of CPP-601 Access Corridor Contamination Surveys: 1961

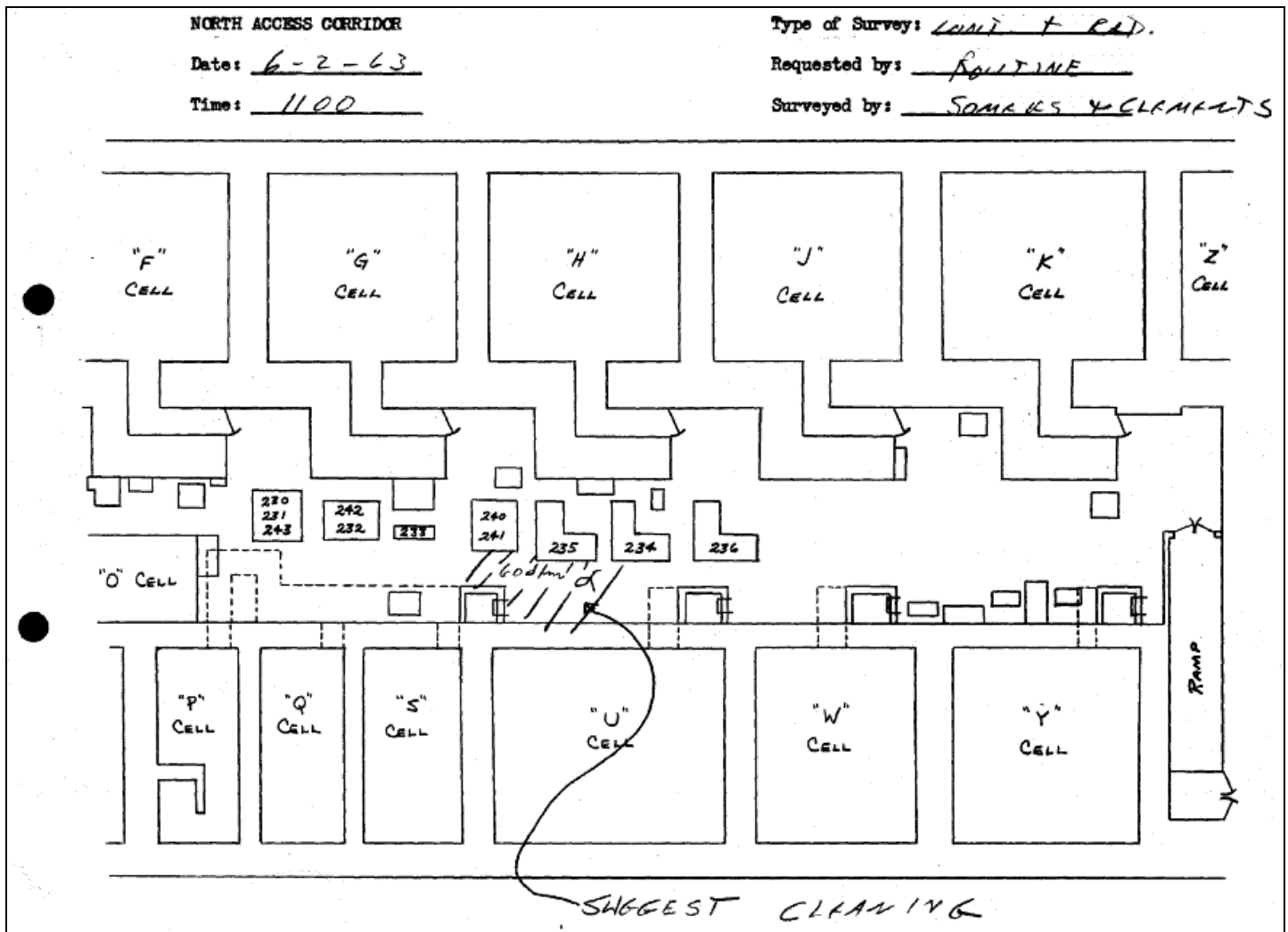

Figure 6-4: Comparison of CPP-601 Access Corridor Contamination Surveys: 1963

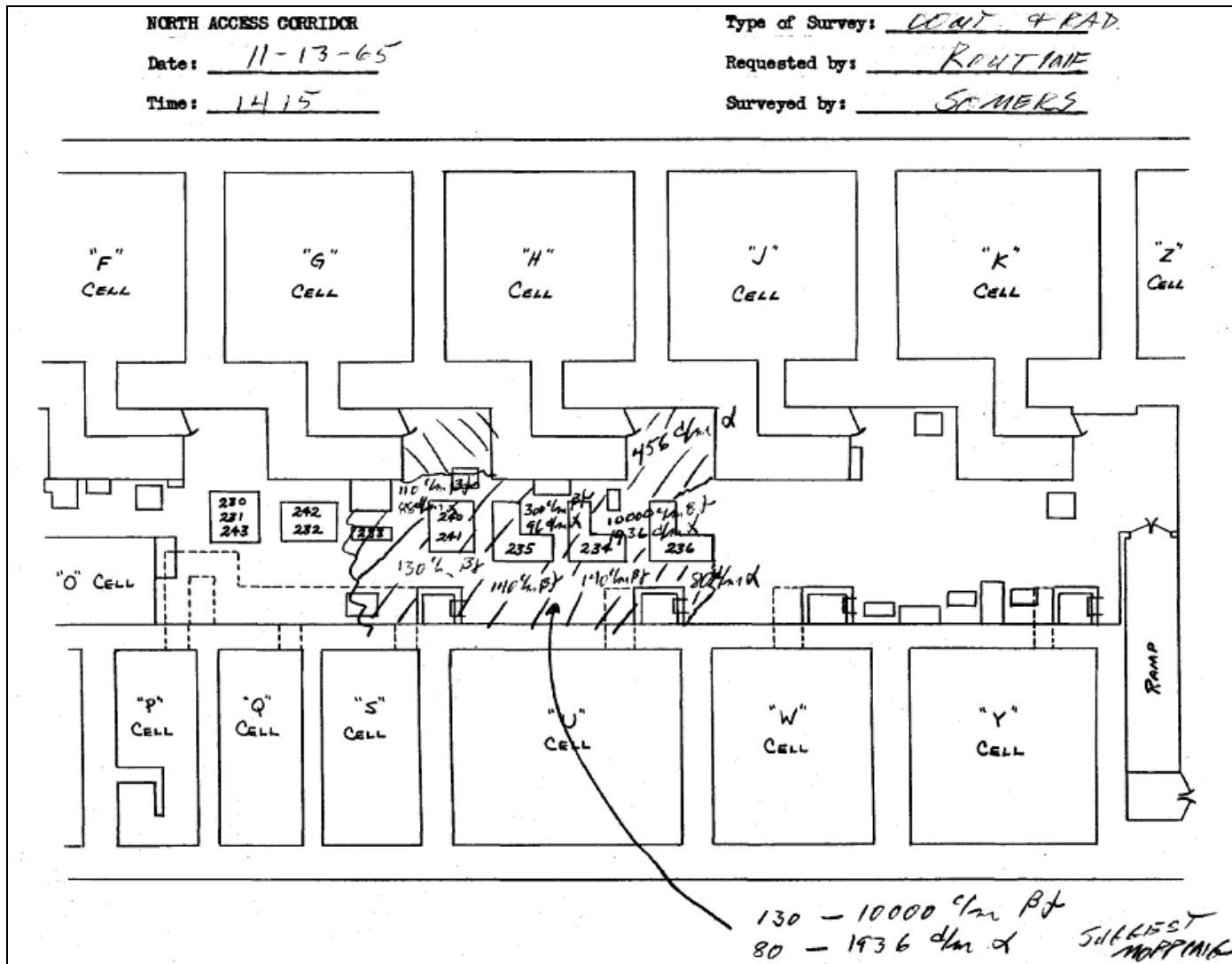

Figure 6-5: Comparison of CPP-601 Access Corridor Contamination Surveys: 1965

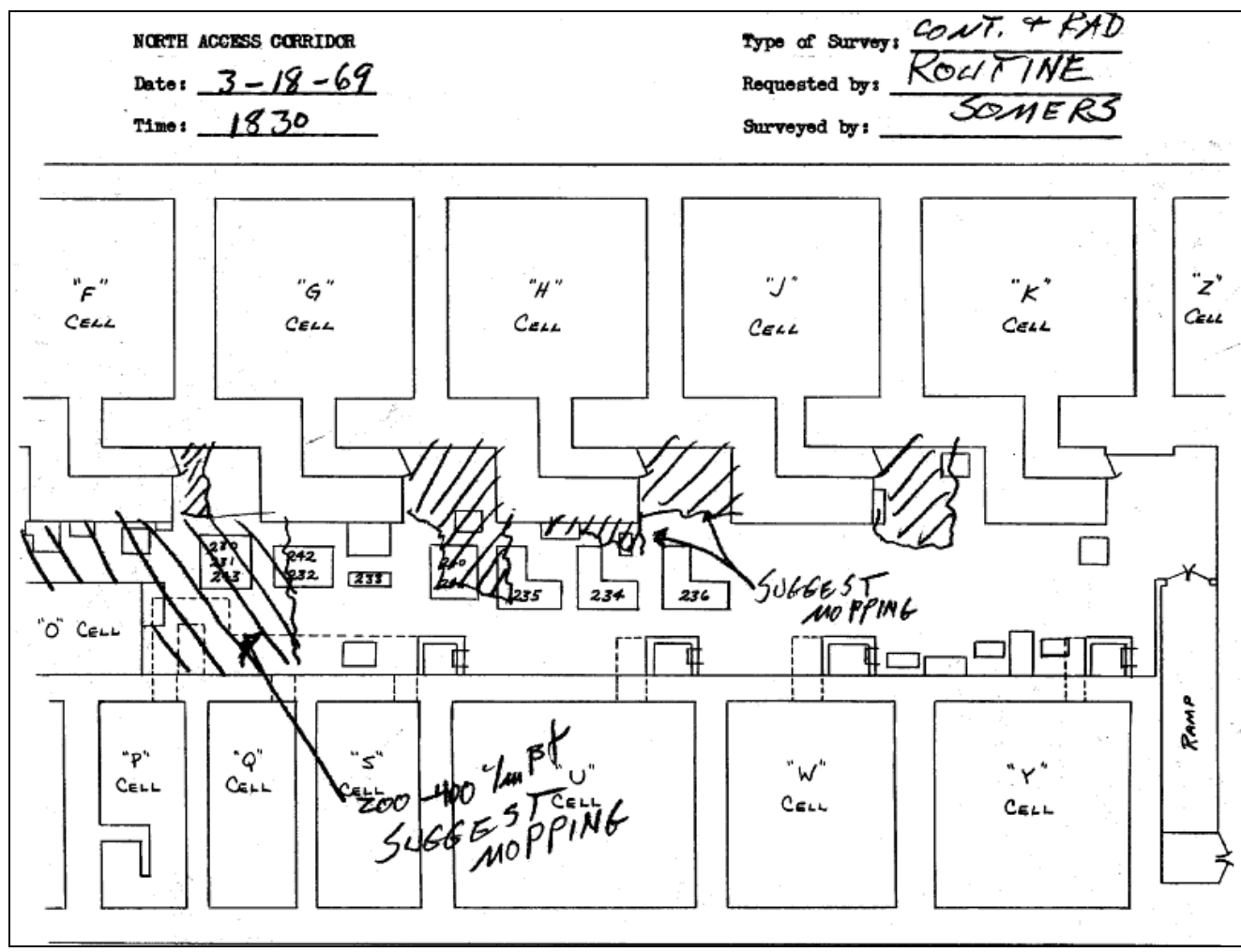
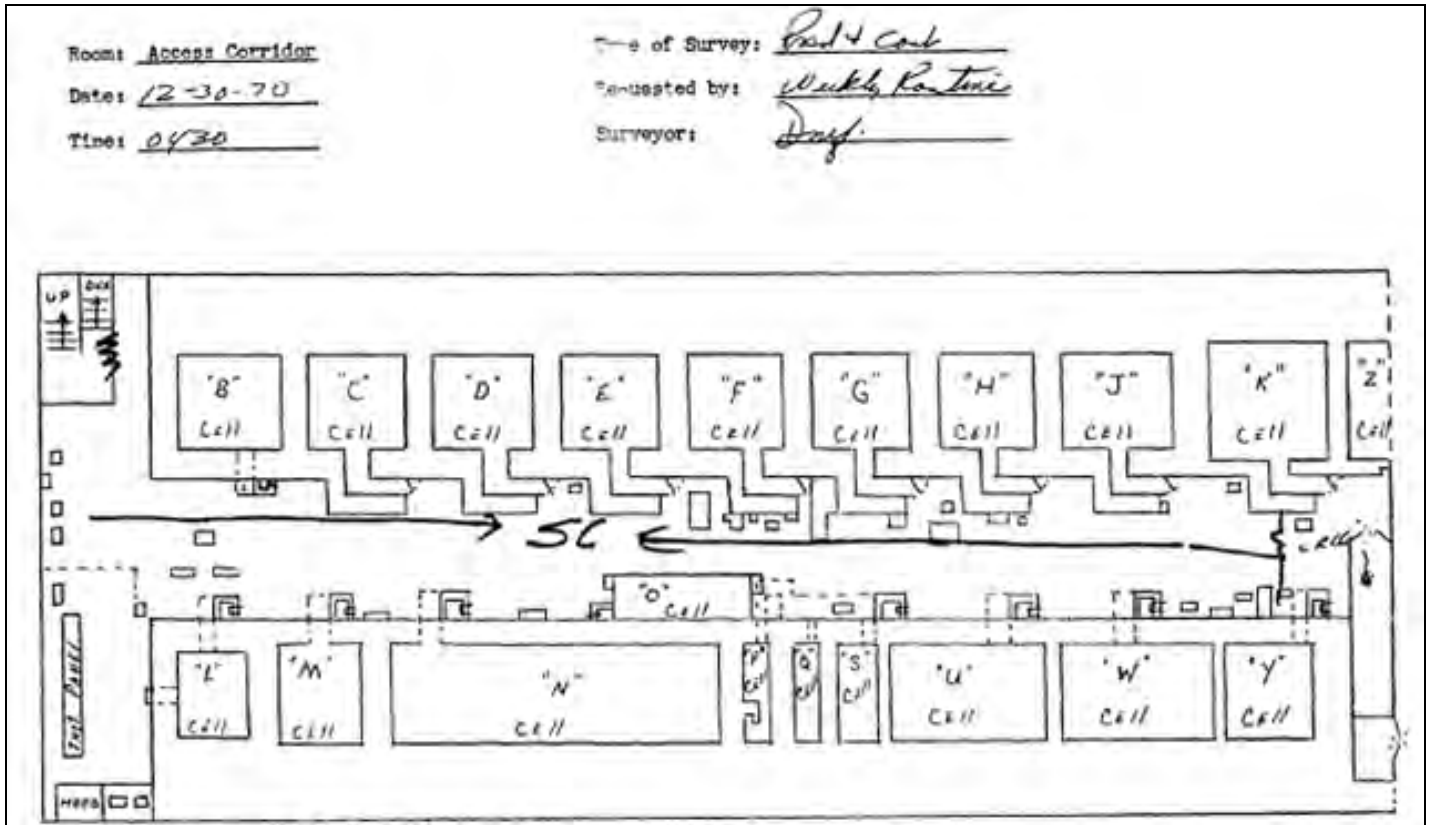

Figure 6-6: Comparison of CPP-601 Access Corridor Contamination Surveys: 1969



Note: "SC" in the above image refers to a Shoe Cover Area.

Figure 6-7: Comparison of CPP-601 Access Corridor Contamination Surveys: 1970

Significant levels of Pu contamination (>10 dpm/ 100 cm^2) were identified in the early 1970s in a number of cells (Rich, 1974).

Procedurally, all routine area surveys should have been spot-checked for alpha by alpha-counting approximately one-fifth of all smears taken. In surveys of areas where alpha-emitters were normally found or expected, all smears were to be counted for alpha contamination. Documentation of incidents and review of the survey data available to NIOSH suggests that personnel did not strictly adhere to this survey frequency (Malmstrom, 1972).

A review of CPP's incident history indicates a long record of repeated contamination incidents and temporary fixes. It is apparent that less-than-adequate contamination-control conditions existed at the CPP for many years - the shift lab being one of the worst examples. Several investigating committees made comprehensive recommendations to correct the conditions and prevent reoccurrences (Rich, 1974). Presumably, due to the difficulty of re-engineering an existing facility, the difficulty of changing worker habit patterns, and the anticipated loss in productivity, these recommendations were not implemented (Condotta, 1981a).

Events involving uncontrolled contamination on personnel and vehicles at CPP-603 in 1970 emphasized the problems there. All surfaces in the building were contaminated to levels of 10^3 to 10^5 dpm/ 100 cm^2 , and some areas and equipment were so highly contaminated that it was impossible to avoid routine personnel contamination (Rich, 1974a). Health Physics procedures specified that Labs 212-216 were to be surveyed by smearing on a weekly basis. Review of Health Physics records and survey log sheets revealed that, for the first seven months of 1972, the laboratories were smeared an average of once per week. Between August and December of that year, the frequency of the routine smear surveys was about once every three weeks, with intervals of up to six weeks between surveys (Malmstrom, 1972).

Figure 6-8 presents an example contamination survey for CPP-204 and CPP-207 in 1968. Note the alpha contamination on open bench tops and a desk (Surveys, 1968).

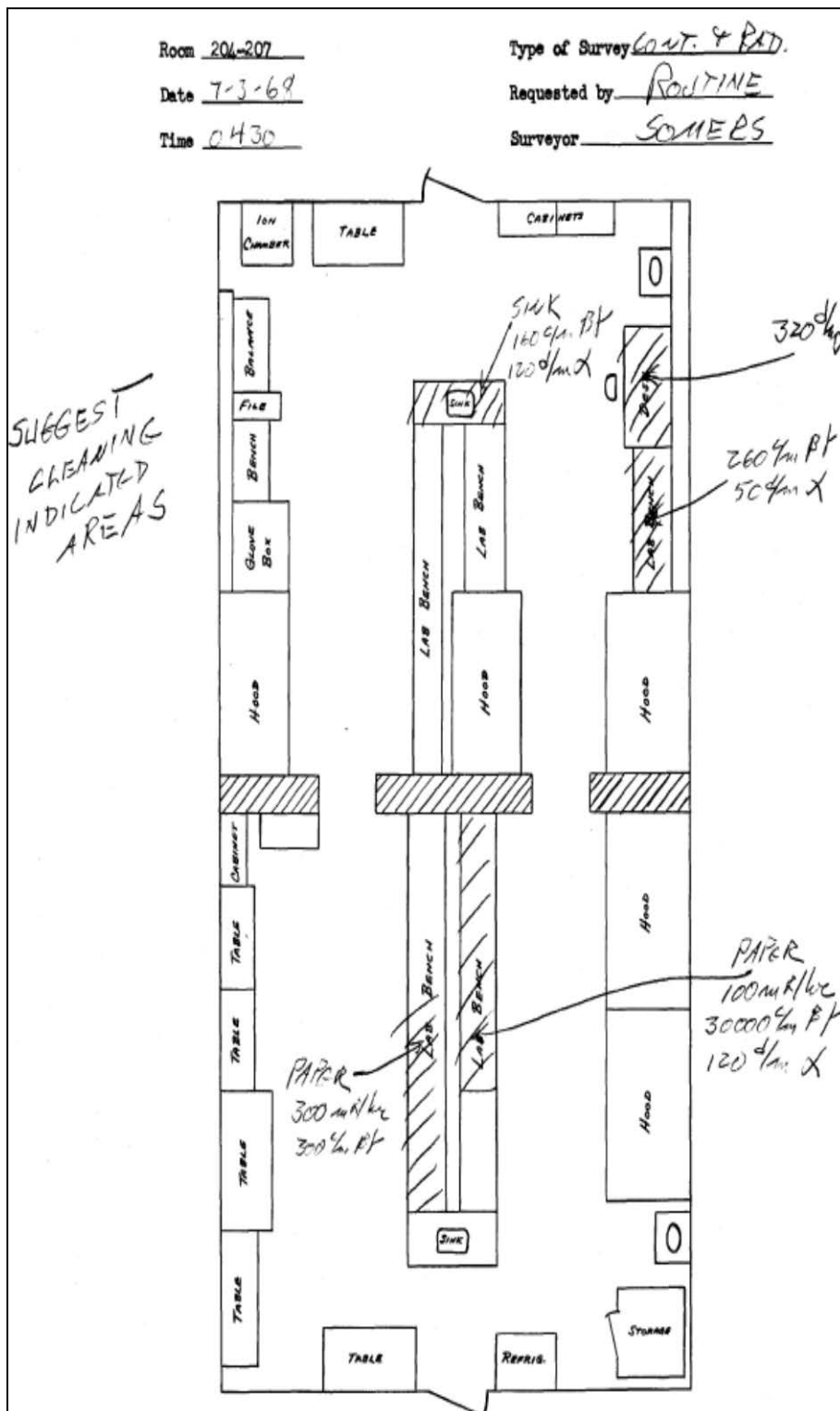

Figure 6-8: Example Contamination Survey for CPP-204 and CPP-207 in 1968

6.3.3 Available Radiological Monitoring Data for TAN

Air Monitoring

The various Health Physics organizations at TAN appear to have monitored the airborne radioactivity for several locations throughout TAN. NIOSH has collected a sampling of TAN air monitoring data for the years 1962–1970 (CAM 1967-1970; CAM, 1962-1963; CAM, 1963-1964; CAM, 1964-1967). A number of ANP Program records indicate that General Electric (GE) monitored airborne radioactivity during the ANP Program era (i.e., prior to 1962) (D101 L2A-1, 1959; Boone, 1959; Levine, 1959); however, NIOSH has not located any of the results for those samples. A 1982 memorandum from GE indicates that the radiological records from the ANP Program are not at the INL site and were likely transferred to GE's Evendale facility when GE's contract with the IDO-AEC terminated (Robertson, 1982).

The available information indicates that airborne radioactivity was monitored using a combination of CAMs, portable air samplers, and fixed head air samplers (referred to as "vacuum air system locations" in the records) (D101 L2A-1, 1959; CAM 1967-1970; CAM, 1962-1963; CAM, 1963-1964; CAM, 1964-1967). During the ANP Program, air samples may have only been analyzed for gross beta-gamma radioactivity (D101 L2A-1, 1959). After the ANP Program, air samples were analyzed for gross beta-gamma radioactivity and gross alpha radioactivity (D101 L2A-1, 1959; CAM 1967-1970; CAM, 1962-1963; CAM, 1963-1964; CAM, 1964-1967).

Radiological Surveys

The various Health Physics organizations at TAN appear to have periodically performed radiological surveys throughout TAN (D101 L2A-1, 1959; TAN Monitoring, 1963). NIOSH has collected a sampling of the TAN radiological data for the years 1964–1968 (TAN Monitoring, 1963). ANP Program records indicate that GE performed radiological surveys during the ANP Program era (i.e., prior to 1962) (D101 L2A-1, 1959); however, NIOSH has not located any of the results for those surveys. A 1982 memorandum from GE indicates that the radiological records from the ANP Program are not at the INL site and were likely transferred to GE's Evendale facility when GE's contract with the IDO-AEC terminated (Robertson, 1982).

The available information indicates that contamination surveys were predominately for beta-gamma radioactivity, but alpha contamination surveys were periodically performed. Figure 6-9 is an example of a 1963 survey schedule for part of the TAN-607 Building (TAN Monitoring, 1963, PDF p. 105). Figure 6-10 is an example of a 1968 contamination survey of the TAN-633 Building (Hot Cell Annex) (TAN Monitoring, 1963, PDF p. 119).

File Month March 1963

TAN AREA MONITORING SCHEDULE

		1	2	3	4	5	6	7	8	9	10	11	12	13	14	15	16	17	18	19	20	21	22	23	24	25	26	27	28	29	30	31		
AREA 1																																		
Equipment Area 1st floor	*3					LC																												
High Bay Ass Area	2					LC													LC															
Maint Office Area	2					LC													LC															
Machine Shop	2					LC													LC															
Maintenance Area	2					LC														LC														
Lunch Room	1					LC						LC							LC															
Instrumentation Area	2					LC														LC														
Component Test Area	2					LC														LC														
AREA 2																																		
Counting Room 118	2					R7																												
Chem Lab Office	2					R7																												
Radio Chem Lab 119	2					R7																												
Radio Chem Lab 119-A	2					R7																												
Warm Service Area	2					R7														R7														
RML Control Room & Corridor	2	R7																		R7														
RML Corridor AREA	2	R7																		R7														
AREA 3																																		
Evap Office Building 616	2					GN														GN														
Corr 107 Fan Room 106	2																																	
Pool Storage Room 102-A	2																																	
North Equipment Gallery	3																																	

*1-Weekly 2-Bi Weekly 3-Monthly

Senses elements

Smith Fixings

Hunt No. 10000

Figure 6-9: Survey Schedule for Part of the TAN-607 Building

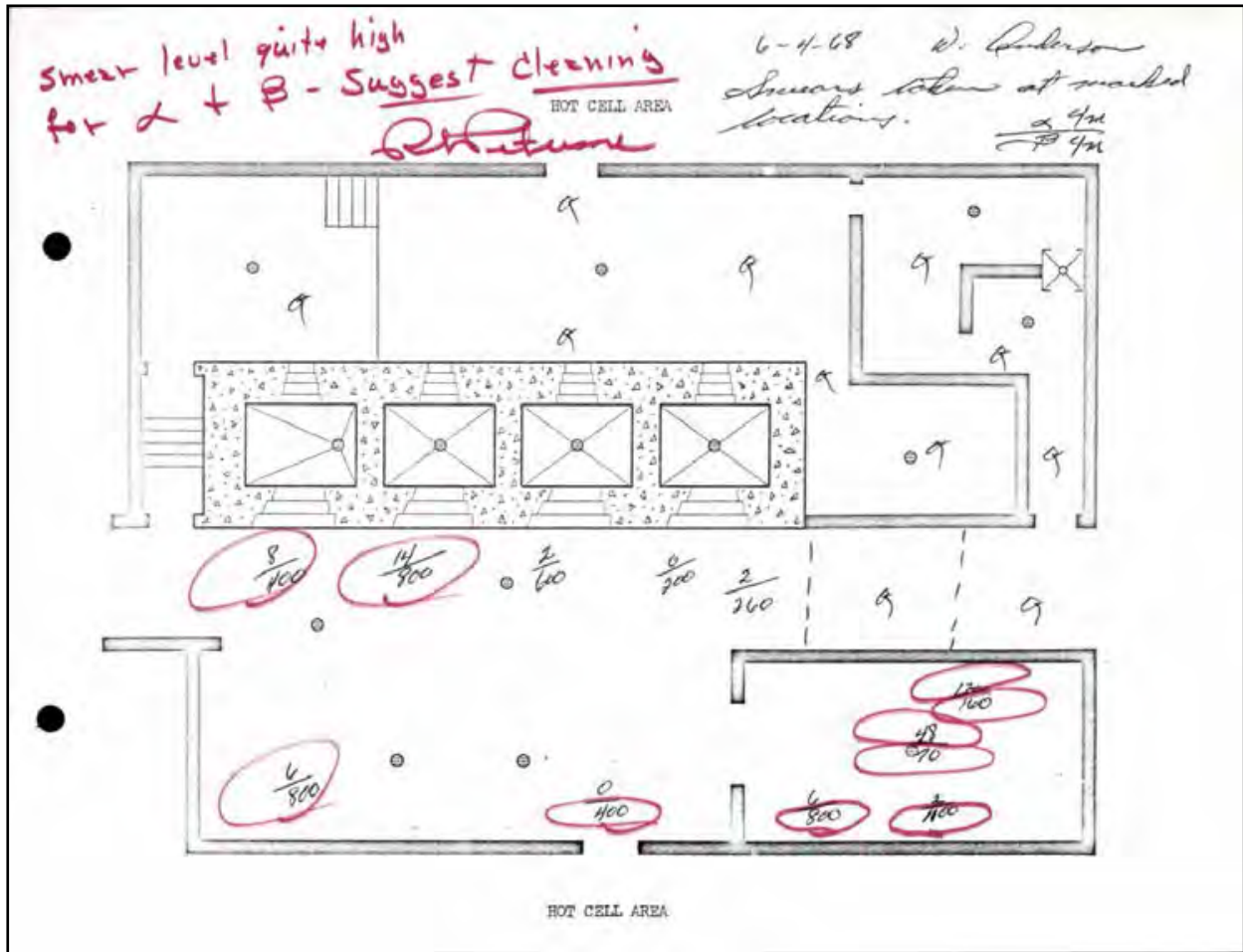

Figure 6-10: Example of Contamination Survey of TAN-633 (Hot Cell Annex)

6.3.4 Available Radiological Monitoring Data for Misc. Reactor Areas

Although the Auxiliary Reactor Area, Organic Moderated Reactor Experiment, and Special Power Excursion Reactor Test facilities were separate and distinct programs, all had sound health physics programs throughout their years of operations. Surveys and air monitoring were consistently and routinely performed, as indicated by monthly reports, activity release reports, and log books (Layfield, 1961a; OMRE, 1959; HP Logbook, 1959). In addition, internal and external appraisals of health physics programs were performed (OMRE HP Survey, 1962-1963). Figure 6-11 shows an excerpt from a SPERT Health Physics Monitoring Report for August 1963 (Terch, 1963).

File: Ter-10-63A	
September 10, 1963	
Page 3	
The 500°F flux wires were removed and replaced with wires for the 600°F power calibration. The maximum radiation body dose by SPERT personnel involved in this operation was 615 mrem for the month.	
SPERT IV	
After four transient tests, the minimum period being 10 msec, the core was disassembled and inspected with no melting being observed. Fuel assemblies were loaded for the stability test series.	
At 3.5 MW the reactor power showed a slight tendency to oscillate with maximum deviations of approximately $\pm 5\%$ of the mean power level and a frequency of about 2 cps. Additional tests are planned with power level increases until oscillations reach a value of $\pm 50\%$ of the mean level.	
<u>SUMMARY OF ROUTINE SERVICES</u>	
Green tags	55
Smears	520
Personnel body decontamination	9
Personnel metering units issued	
Direct reading dosimeters	65
Film rings	6
Hand and Foot counts made	60
Body Fluid samples	
Routine	15
Special	0
Whole body analysis	0
Liquid samples taken	
Reactor water	3
Well water	2
Radioactive shipments	
Incoming	1
Outgoing	22
Safe work permits	0
First aid treatments	
Occupational injuries	8
Non-occupational treatments	23
Laundry	
Coveralls to laundry	16
Towels	48
Clothing discarded	
Latex gloves	16
Coveralls	0
Burial ground	1

Figure 6-11: Excerpt from SPERT Health Physics Monitoring Report, Aug. 1963

6.3.5 Available Radiological Monitoring Data for CFA

The Central Facilities Area was unique to INL in that CFA employees worked “outside of plant fences.” Radiation or contamination issues were typically encountered inside fenced areas. However, there were specific areas at CFA where safe work permits and protective clothing were required as precautions. Contamination surveys and air monitoring were routinely performed in these areas to monitor internal exposures (CFA HP Logs, 1965-1966). This monitoring was summarized in CFA Health Physics monthly reports. Figure 6-12 shows an excerpt from a CFA Health Physics Monthly Report for July 1961 (Johnson, 1961).

File: Sav-9-61A
August 11, 1961
Page 2

HOT CELL

The background radiation from the SL-1 still interferes to some extent with the settings on our radiation instruments. This background at present is between 0.2 and 1 mr/hr inside the Hot Cell building and 2 to 5 mr/hr outside but within the fenced area.

To the east and south of the hot cells, shipments up to levels of 500 r/hr, although shielded, are sent to ANP. Shielding is limited in transit. No exposure above levels ordinarily permitted is known to have occurred at this hot cell area.

BURIAL GROUNDS

Burials:

On site shipments received at burial grounds	45
Off-site shipments received at burial grounds	?

Pickup of hot waste from areas where there is no Dempster Dumpster is sometimes done by using a dumpster from another area. Then it might be more economical in some areas to fill one dumpster before using a second one, thus saving trips to the burial grounds.

An incident involving a truck and a driver bringing in waste for burial has been recorded on a separate report. The truck driver's clothing was washed at the CFA laundry and returned.

A separate radioactive waste report has been submitted.

ROUTINE JOBS

Instrument checks	325 (estimated)
Special air samples	6
Smears collected and counted	300 (estimated)
Radioactive shipments on site	98
Radioactive shipments off-site	0

Rough drafts of standard operation procedures have been written for CFA, AREA, and the burial grounds and submitted for review on August 15.

Very truly yours,

Figure 6-12: Excerpt from CFA Health Physics Monthly Report, Jul. 1961

6.3.6 Available Radiological Monitoring Data for the Burial Ground

Safe Work Permits and monitoring practices at the Burial Ground (e.g., required air monitoring) indicate contemporary controls and enforcement of restricted areas and transportation vehicles. A health physicist was required to be present for waste disposal and also had overall responsibility for Burial Ground operations. Entry and exit monitoring served as the crux of contamination control for personnel and vehicle contamination control throughout the evaluation period. Figure 6-13 shows a Safe Work Permit for RFP waste burial at the INL Burial Ground for April 1964 (SWP 1962-1964)

FORM 882-17
REV. 5
(REV. 8-1-63)

SAFETY DIVISION

SAFE WORK PERMIT

DATE: 4/24/64

APPROVED: TO: 4/24 DATE: 1964

JOB: *CF-Mount*

LOCATION: *Burial Ground*

JOB DESCRIPTION: *Load Rocky Plate Trucks*

WORK ORDER NO: *03-1425*

EXTENDING DATA: *< RFG*

MAXIMUM TIME: *8 hours/day*

HEALTH PHYSICIAN: 1. PRE-START CHECK
 2. NO PERSONAL CLOTHING
 3. AIR MONITORING IN WORKING AREA
 4. PERSONAL SURVEY ON COMPLETION
 5. AREA SURVEY ON COMPLETION
 6. MONITORING AT START ONLY
IN AREA: CONTINUOUS

SAFETY: 7. HAZARDOUS AREA TEST
 8. RELEASE AND BURNING
 9. SUSPICION OF FALSE TAG OUT
 10. VESSEL LEAKS
 11. LOCATION OF EQUIPMENT
 12. OPERATOR TEST (DAILY)
 13. AVOID SHOT AND POOL AREAS

WORKING: 14. SPECIAL TIME LIMITS
 15. NOTIFY CONTROL DESK
 16. CLEAN UP WORK AREA BY GROUP LEADER AT THE END

MANDATORY TERMINATION OF JOB BY: *TIME* DATE: *Friday April 24, 1964*

SPECIAL INSTRUCTIONS: *clean up work area when through, misc paper & packing, safety shoes worn by all members as work. This work order covers activity of job 4/21-4/29/64*

APPROVALS: APPROVED (INDICATED BY CHECKS) AND OBTAINED AND SAFETY INSTRUCTIONS ARE WRITTEN. SPECIAL INSTRUCTIONS ARE FOLLOWED.

PERSONNEL	CONTINUE FROM INITIAL		ENTRY - END DATE		ENTRY - END SHIFT		SAP FACILITATED	JOB COMPLETED
	INITIALS	COMPLETION	DATE	INITIALS	DATE	INITIALS		
HEALTH PHYSICIAN								
SAFETY								
AREA COPY								
OTHER								
JOB SUPERVISOR								

NAME	JOB TIME LIMIT ON JOB	PROTECTIVE EQUIPMENT REQUIRED - YES																
		RESISTANT	NON-RESISTANT	RESISTANT	NON-RESISTANT	RESISTANT	NON-RESISTANT											
[REDACTED]								RESISTANT EQUIPMENT	FACE SHIELD									
									RESISTANT GLOVES									
									RESISTANT SHOES									
									RESISTANT SLACKS									
									RESISTANT T-SHIRT									
									RESISTANT UNDERWEAR									
									RESISTANT SOCKS									
									RESISTANT CAP									
									RESISTANT GOGGLES									
									RESISTANT MASK									

PERMIT TERMINATED: TIME: DATE: *4-29-64* INITIALS: [REDACTED]

DISTRIBUTION: YELLOW - HEALTH AND SAFETY; WHITE - SUPERVISOR; BLUE - CARRY ONE IN HAND AND ONE

Figure 6-13: Safe Work Permit for RFP Waste Burial at INL Burial Ground, Apr. 1964

7.0 Feasibility of Dose Reconstruction for the Class Evaluated by NIOSH

The feasibility determinations for the class of employees under evaluation in this report are governed by both EEOICPA and 42 C.F.R. § 83.13(c)(1). Under that Act and rule, NIOSH must establish whether or not it has access to sufficient information either to estimate the maximum radiation dose for every type of cancer for which radiation doses are reconstructed that could have been incurred under plausible circumstances by any member of the class, or to estimate the radiation doses to members of the class more precisely than a maximum dose estimate. If NIOSH has access to sufficient information for either case, NIOSH would then determine that it would be feasible to conduct dose reconstructions.

In determining feasibility, NIOSH begins by evaluating whether current or completed NIOSH dose reconstructions demonstrate the feasibility of estimating with sufficient accuracy the potential radiation exposures of the class. If the conclusion is one of infeasibility, NIOSH systematically evaluates the sufficiency of different types of monitoring data, process and source or source term data, which together or individually might assure that NIOSH can estimate either the maximum doses that members of the class might have incurred, or more precise quantities that reflect the variability of exposures experienced by groups or individual members of the class as summarized in Section 7.6. This approach is discussed in DCAS's SEC Petition Evaluation Internal Procedures which are available at <http://www.cdc.gov/niosh/ocas>. The next four major subsections of this Evaluation Report examine:

- The sufficiency and reliability of the available data. (Section 7.1)
- The feasibility of reconstructing internal radiation doses. (Section 7.2)
- The feasibility of reconstructing external radiation doses. (Section 7.3)
- The bases for petition SEC-00219 as submitted by the petitioner. (Section 7.4)

7.1 Pedigree of INL Data

This subsection answers questions that need to be asked before performing a feasibility evaluation. Data Pedigree addresses the background, history, and origin of the data. It requires looking at site methodologies that may have changed over time; primary versus secondary data sources and whether they match; and whether data are internally consistent. All these issues form the bedrock of the researcher's confidence and later conclusions about the data's quality, credibility, reliability, representativeness, and sufficiency for determining the feasibility of dose reconstruction. The feasibility evaluation presupposes that data pedigree issues have been settled.

7.1.1 Internal Monitoring Data Pedigree Review

Upon request, INL provides database printouts and copies of original hardcopy bioassay results, and whole-body-count/chest-count records. NIOSH has obtained both bioassay results and a limited number of air monitoring results for the period under evaluation. Bioassay sample results were obtained starting in 1953. The bioassay results are urinalyses starting in 1953; fecal sample results start in 1961. NIOSH has also obtained whole-body-counting results starting in 1961.

A large amount of raw bioassay data exists at INL. Many of these records have been compiled into a single database with a data validation and comment field added to each record. These data are in the process of being cross-verified with scanned copies of 32,951 pages of internal dosimetry records (Bioassay, 1956-1984; Bioassay, 1956-1967; Bioassay, 1958-1986). Duplicate records and unusable records (e.g., gross errors) are not included in this assessment.

There have been a number of "spot checks" performed to confirm the integrity of the *in-vitro* radiobioassay dataset for INL. These spot checks took the form of:

1. Capturing hard copy records of bioassay records and checking the results against the dataset
2. Having INL generate a listing of all monitoring records for 12 workers and checking the values against the dataset

These "spot checks" consisted of:

- Termination *in-vitro* results for 24 Fluor Corporation workers between August 15, 1958 and November 23, 1958
- Routine and special *in-vitro* results for 95 workers in 1963 for gamma, Pu, Sr, and U analyses
- All *in-vitro* records for 12 INL workers, including chemists believed to have been involved in Pu separations
- CF-669 laundry workers, as identified from external dosimetry reports

In all the cases above, the results were found in the INL *in-vitro* radiobioassay dataset or the PDFs used to create the dataset. An exhaustive internal data pedigree review of the databases has not been performed because of the existence of original hard-copy personnel records. Additional checks of the data in the databases will be performed and documented as part of the development of the internal dose co-worker studies that are planned for INL.

7.1.2 External Monitoring Data Pedigree Review

Upon request, INL provides database printouts and copies of original hard-copy external dosimetry results. NIOSH has obtained personnel dosimetry information and area monitoring data for the period under evaluation. External dosimetry results were obtained starting in 1952. A large amount of personnel dosimetry data exists at INL, including duplicate records and unusable records (e.g., gross errors). NIOSH has determined that all the workers in INL's radiological areas were monitored for external dose and the dose values exist in original hard-copy form as well as database form, which is (and has been) provided by DOE for each worker. In addition to the dosimetry data that are considered a primary resource for supporting external dose reconstructions, NIOSH also has access to INL area monitoring data (including radiation survey data and source-term information) as well as onsite ambient (environmental) data, which are also in original hard-copy form. These data support the assignment of onsite ambient doses for all monitored INL workers to account for any radiation dose that may have been inappropriately subtracted from their dosimeter results as background radiation, as well as the assignment of dose to unmonitored individuals.

7.2 Evaluation of Bounding Internal Radiation Doses at INL

The principal sources of internal radiation doses to members of the proposed class would have been inhalation and ingestion of radiological contamination during the following operations:

- Destructive and non-destructive nuclear reactor tests
- Irradiation of experimental nuclear reactor fuels
- Irradiation of various materials to transform them by neutron bombardment and/or to study their behavior within a nuclear reactor environment
- Chemical separation of highly-enriched uranium from irradiated fuel elements
- Chemical separation of neptunium from irradiated fuel elements
- Research and development activities, including human and environmental studies
- Waste management operations supporting all site radiological activities

The potential internal sources would have been dependent on the operational area and activities. The major sources of intakes, as indicated in the bioassay records and incident reports, have been mixed fission products (often limited to radioactive iodines and noble gases), activation products, uranium, and plutonium. However, the records list a wide spectrum of radionuclides that were monitored and an even longer list of codes used to identify the radionuclides, groups of radionuclides, specific measurement techniques, or combinations of radionuclides and techniques. Many of the radionuclides apply to a small set of workers on a research project or to workers whose tasks could have exposed them to many different sources (e.g., radiation monitoring technicians) (ORAUT-TKBS-0006-5).

To provide consistency to INL radiation safety programs given the large variety of facilities and constantly-changing contractors, the AEC established a Health and Safety (H&S) Laboratory at INL to provide technical support for internal and external dosimetry programs. The H&S Laboratory was operated by the AEC rather than one of its INL contractors. The name of this organization changed to Health Services Laboratory (HSL), then to the Health and Safety Division (HSD), then to the Idaho Center for Radiological and Environmental Sciences, and most recently to the Radiological and Environmental Sciences Laboratory (RESL). During the period under evaluation, *in-vitro* bioassay samples collected throughout INL were analyzed by the chemistry laboratory HSL, which was located in Building CF-646 in the CFA. In 1963, *in-vitro* bioassay analysis was moved to a new laboratory in Building CF-690. With the move to CFA-690 in 1963, the whole-body counting facilities were housed in the same buildings as the bioassay labs. A newly-designed counter was used from the onset of CFA-690 operations (Puphal, 1994).

For INL EEOICPA claims, ambient environmental internal doses are only assessed for certain unmonitored workers, as discussed in the guidance in ORAUT-TKBS-0007-6, Section 5.6. ORAUT-TKBS-0007-4 and its supplement (Peterson, 2004) provide the historical background, rationale, and environmental intake data for reconstructing occupational environmental internal doses at the INL site. In summary, ORAUT-TKBS-0007-4 provides annual environmental intakes of the significant radionuclides for each major operating area on the INL site. Because environmental exposures are accounted for in personnel occupational exposures and do not impact the ability to reconstruct dose with sufficient accuracy, further assessment of environmental internal exposure is not included in this report.

The following subsections address the ability to bound internal doses, methods for bounding doses, and the feasibility of internal dose reconstruction for the six operating areas under evaluation.

7.2.1 Evaluation of Bounding Internal Doses for TRA

7.2.1.1 Evaluation of Bounding Process-Related Internal Doses for TRA

The principal sources of internal radiation doses for members of the class working at the Test Reactor Area include plutonium and other transuranic radionuclides, uranium, thorium, and mixed fission products. The following subsections address the ability to bound internal doses, methods for bounding doses, and the feasibility of internal dose reconstruction.

A tabular representation of the feasibility of reconstructing doses is presented in Table 7-1, where the dark green cells with an “F” indicate reconstructions that are feasible and the lighter green cells with a “C” indicate reconstructions that are feasible but a mixed-fission-product co-worker model is needed. The rationale for these feasibility designations is presented in the following subsections.

Exposure Source	Years																		
	52	53	54	55	56	57	58	59	60	61	62	63	64	65	66	67	68	69	70
Mixed Fission Products	F	F	F	F	F	F	F	F	F	F	F	F	F	F	F	C	C	C	C
Plutonium	F	F	F	F	F	F	F	F	F	F	F	F	F	F	F	F	F	F	F
Other	F	F	F	F	F	F	F	F	F	F	F	F	F	F	F	F	F	F	F
Photon	F	F	F	F	F	F	F	F	F	F	F	F	F	F	F	F	F	F	F
Neutron	F	F	F	F	F	F	F	F	F	F	F	F	F	F	F	F	F	F	F

F = Dose reconstructions are feasible.

C = Dose reconstructions are feasible but a mixed-fission-product co-worker model is needed.

Urinalysis Information and Available Data

As previously discussed in Section 7.1, there are extensive urine bioassay data that NIOSH believes are sufficient, along with whole-body count (*in vivo*) analysis results, for bounding internal radiation doses from plutonium, uranium, and mixed fission products. Sampling was done annually, quarterly, or as the Heath Physicist ordered, with more frequent sampling done following an incident. In the 1960s, fecal analyses were incorporated into the bioassay program to assess any possible lung burden from the alpha-emitting radionuclides.

In the available data, the earliest urine bioassay data collected from TRA workers are for plutonium starting in 1955, uranium in 1955, transuranic radionuclides in 1959, and fission products in 1953 (Bioassay, 1956-1984; Bioassay, 1956-1967; Bioassay, 1958-1986). The earliest *in vivo* data for TRA workers in the available data are for 1961. The *in vivo* data will be used with urinalysis results to bound doses received from X-ray and gamma-emitting radiation. The number of samples by type and year are provided in Table 7-1.

TRA controlled exposure to airborne and re-suspended radioactivity by continuous air monitoring (CAM) and smear survey programs. Examples of CAM are available (Air Monitoring, 1965-1966, Air Monitoring, Feb1953-Oct1954, Air Monitoring, Dec1956-Aug1957, Keller, 1958, Air Monitoring, 1966-1967, Air Monitoring, 1966, Air Monitoring, Mar1965-Dec1966). Examples of contamination survey data are available (Survey, Jun1958, Survey, Nov1958, Survey, Oct1955, Survey, May-Jun1955, Survey, Aug-Dec1953, Survey, Apr1963, Survey, Aug1968, Survey, Jul1963, Survey, Apr1969). During the period under evaluation, routine urinalysis and whole-body-count programs were conducted at TRA for intakes of fission and activation products (WBC1, 1961-1977; WBC2, 1963-1995; WBC3, 1981-1994; WBC4, 1979-1995; WBC5, 1973-1996). From 1961 until 1966, TRA workers were given whole-body counts on a routine frequency based on their potential for exposure (Sommers, 1961; McCaslin, 1963). By 1965, whole-body counting became the analysis of choice to determine intakes of fission products. INL employed an incident-based bioassay program for detection and quantification of intakes of radioactive material. INL determined that whole-body counting provided the necessary detection sensitivity for most fission products, and in some cases, provided detection superior to urinalysis, even if using 24-hour urine sample (Puphal, 1994, PDF p. 11). In 1967, INL changed whole-body-count frequency to randomly counting one-fourth of the workforce each year whereby each worker would be counted every four years (Sommers, 1966). A roster of workers to be counted in 1968 is available (Sommers, 1968).

Special samples were collected from workers when either results of CAM or smear surveys suggested internal exposure (McCaslin, 1963). As stated in Section 5.4.1, there were often releases of fission product radionuclides. Special urinalysis or *in-vivo* analyses were requested when incidents resulted in airborne radioactivity being detected. NIOSH has obtained bioassay for TRA incidents involving fission products and alpha-emitters. Results provided in Table 7-2 for plutonium, uranium, and transuranic radionuclides represent special samples collected following alpha-based incidents or where smear-survey results exceeded TRA guideline values. For the Pu-240 incident that occurred in TRA in 1963, 99 bioassay samples were collected from 78 workers exposed to the contamination. One sample from each of six people was statistically positive. Those results ranged from 0.18 ± 0.003 to 0.0014 ± 0.0005 d/m/ml. This highest reading was later proved to be a false positive resulting from reagent contamination. The results of all subsequent samples were below the detection limit of 0.0004 d/m/ml based on a sample size of 1000 ml (Horan, 1963). One [role redacted] was involved in more than one incident involving [radionuclide redacted]. NIOSH has obtained [radionuclide redacted] results for that worker in 1960, 1963, 1964, 1965, 1967, and 1968. Those results are shown in Table 7-3.

Table 7-2: Special Samples Collected at the TRA						
Year	Urinalysis	Plutonium	Uranium	Transuranic	MFP/AP	<i>In Vivo</i>
1953	-	-	-	-	338	-
1954	-	-	-	-	668	-
1955	-	3	3	-	1063	-
1956	-	-	6	-	1822	-
1957	-	-	3	-	3272	-
1958	-	-	-	-	2701	-
1959	-	11	4	1	3215	-
1960	-	4	15	-	3346	-
1961	-	5	1	2	3286	1004
1962	-	-	1	-	3139	1890
1963	-	137	1	-	2912	2592
1964	-	25	-	6	2989	1062
1965	-	6	6	1	2297	1086
1966	-	1	2	6	1133	920
1967	-	12	1	-	47	237
1968	-	11	-	-	26	310
1969	-	13	-	1	19	261
1970	-	-	-	-	7	460

Note: Values represent special samples collected with the occurrence of alpha-based incidents or where smear survey results exceeded TRA guide values.

Table 7-3 [Radionuclide redacted] Bioassay Results for [Location and Role redacted]		
Date	Result	Units
2/18/1960	<7.00E-04	dpm/mL
3/15/1963	<2.1E-10	uCi/mL
3/16/1964	<4.00E-04	dpm/mL
3/11/1965	<8.00E-04	dpm/mL
3/11/1965	<7.00E-04	dpm/mL
10/6/1967	<4.00E-04	dpm/ml
1/31/1968	<4.00E-04	dpm/mL
4/12/1968	<3.00E-04	dpm/mL

Airborne Levels

TRA controlled exposure to airborne and re-suspended radioactivity by CAM and smear survey programs. Examples of CAM are available (Air Monitoring, 1965-1966, Air Monitoring, Feb1953-Oct1954, Air Monitoring, Dec1956-Aug1957, Keller, 1958, Air Monitoring, 1966-1967, Air Monitoring, 1966, Air Monitoring, Mar1965-Dec1966). Examples of contamination survey data available: (Survey, Jun1958, Survey, Nov1958, Survey, Oct1955, Survey, May-Jun1955, Survey, Aug-Dec1953, Survey, Apr1963, Survey, Aug1968, Survey, Jul1963, Survey, Apr1969). NIOSH does not intend to use air monitoring results to bound potential doses of radiation; rather, these data will be used to demonstrate the daily capability of detecting airborne radioactivity.

Alternative Data Sources for Bounding Internal Dose

The contamination control limits employed for the detection and control of released activity beyond the control boundaries related to: (1) instrumentation capabilities; and (2) the basic philosophy of the acceptance of detectable contamination. The contamination control limits for alpha on plant surfaces, and particularly personnel, were set close to the MDA, so that any detectable contamination was a signal for preventive and follow-up evaluations and actions. From the onset of operations through the end of the 1960s, control levels on smear surveys were set at 500 dpm β and 20 dpm α per 100 cm². From the 1970s to the termination of CPP operations, smear control levels were set at 300 dpm β and 20 dpm α per 100 cm². Table 7-4 provides the total number of smear surveys taken at MTR and ETR by year for five of the years for which INL reported the number of smears taken; these data are from MTR Health Physics and ETR Health Physics monthly reports that are currently available to NIOSH. The smears reported for ETR are lower in 1958 and 1959 as those were early years of operation for ETR and MTR. Smear data for TRA facilities for each month are available for data capture at INL.

Year	No. of MTR Surveys Taken	No. of ETR Surveys Taken	SRDB Ref ID
1958	81700	15174	87084, 87090
1959	*	12908	87091
1962	*	56450	139240
1965	111400	64200	139164, 139299
1966	69600	74800	139196, 139169

*Only partial smear results available

7.2.1.2 Methods for Bounding Operational Period Internal Dose for TRA

Uranium

The potential for uranium exposures was minimal because TRA used encapsulated fuel sources. TRA Health Physics used air monitoring data and contamination smear data to control potential uranium exposure. An interview with a former [organization redacted] staff member stated that exposure to airborne uranium was not an issue at TRA (Personal Communication, 2014i). In the few instances in which fuel capsules were ruptured in a lab or research setting, TRA collected bioassay samples. NIOSH will use these data to reconstruct doses to the exposed workers.

Fission Products

Workers with potential for exposure to fission and activation products due to releases of radioactive materials at TRA reactors, laboratories, and ancillary facilities were routinely monitored by both urinalysis and whole-body counting from the onset of radioactive operations at MTR through 1966. NIOSH will reconstruct intakes from potential exposures, using both urinalysis and *in-vivo* monitoring records supplied by DOE. Since TRA incorporated an *in-vivo* counting frequency of twenty-five percent of workers per year starting in 1967, NIOSH will develop a co-worker data model for fission-product intakes for 1967 through 1970 to complement monitoring data supplied by DOE.

At TRA, urine samples were typically analyzed only for gross beta, gross gamma, and/or strontium radioactivity. For such samples, NIOSH will assess missed Sr-90 and/or Cs-137 intakes in accordance with ORAUT-OTIB-0054 and ORAUT-OTIB-0060. Similarly, NIOSH will assess missed Cs-137 intakes when using *in-vivo* data in accordance with ORAUT-OTIB-0060.

Plutonium and Actinides

A limited known set of workers worked with un-encapsulated plutonium, americium and other actinides in TRA hot cells and laboratories, primarily after 1961 in the MTR Alpha Labs. NIOSH will reconstruct intakes from known exposures to actinides using worker monitoring data supplied by DOE. NIOSH may develop a co-worker actinide model to reconstruct doses for the period 1967 through 1970 using the monitoring data supplied by DOE for a chemist known to have had high potential for actinide exposure (see Table 7-3).

7.2.2 Evaluation of Bounding Internal Doses for CPP

To evaluate the petitioner concerns regarding internal exposures at CPP, NIOSH investigated the source term, available personnel monitoring records, and air sample data, as needed. Based on this information, NIOSH made a determination regarding the feasibility of reconstructing internal doses.

The original design philosophy for CPP based the routine monitoring and control program on fission products as the controlling radionuclides. That is, if fission products were controlled to permissible levels, the alpha radiation hazards would automatically be adequately controlled. However, the varying fuels used as feedstock changed this original concept so that, in parts of the process, alpha hazards were limiting (Plutonium, 1980).

A tabular representation of the feasibility of reconstructing doses is presented in Table 7-5, in which the dark green cells with an “F” indicate reconstructions that are feasible, the light green cells with a “C” indicate reconstructions that are feasible but a mixed-fission-product co-worker model is needed, and the red cells with an “I” indicate that an infeasibility exists for that particular exposure type. The rationale for these feasibility designations is presented in the following subsections.

Exposure Source	Years																					
	53	54	55	56	57	58	59	60	61	62	63	64	65	66	67	68	69	70	71	72	73	74
MFP	F	F	F	F	F	F	F	F	F	F	F	F	F	F	C	C	C	C	C	C	C	C
Pu/Np	F	F	F	F	F	F	F	F	F	F	I	I	I	I	I	I	I	I	I	I	I	I
Uranium	F	F	F	F	F	F	F	F	F	F	I	I	I	I	I	I	I	I	I	I	I	I
Th/Transuranics	F	F	F	F	F	F	F	F	F	F	I	I	I	I	I	I	I	I	I	I	I	I
Other	F	F	F	F	F	F	F	F	F	F	F	F	F	F	C	C	C	C	C	C	C	C
Photon	F	F	F	F	F	F	F	F	F	F	F	F	F	F	F	F	F	F	F	F	F	F
Neutron	F	F	F	F	F	F	F	F	F	F	F	F	F	F	F	F	F	F	F	F	F	F

F = Dose reconstructions are feasible.

C = Dose reconstructions are feasible but a mixed-fission-product co-worker model is needed.

I = Dose reconstructions are infeasible.

7.2.2.1 Evaluation of Bounding Process-Related Internal Doses for CPP

Urinalysis and Fecal Information and Available Data

CPP was designed as a closed process, where dissolution equipment and separation equipment were handled remotely (Stroschein, 1967). Process samples and research quantities of radioactive materials were handled within glove boxes and remotely handled within the Remote Analytical Facility. There were no indications of breaches to the glove boxes in any of the reviewed documents, in any of the employee interviews, or in the petition. However, the process-sampling methods and direct-contact maintenance structure provided the means by which workers could come in contact with radioactive materials.

INL had a routine monitoring program for a large portion of its history. That monitoring program was based largely on gross-gamma and beta analyses of urine samples. Incident-prompted special analyses were also performed, but not to a degree that would allow for the bounding of exposures to transuranics considering that the general attitude at CPP toward low-level contamination appeared to be too complacent (Rich, 1974). In 1966, the routine collection of urine samples was halted in favor of a routine whole-body counting procedure (McCaslin, 1966a). Table 7-6 provides internal monitoring records for CPP from 1954 to 1975.

Table 7-6: CPP-Specific Internal Monitoring Records							
Year	β/γ Urine	α/β Urine	Uranium Urine	Plutonium Urine	Plutonium Fecal	Neptunium Fecal	Whole Body Counts
1954	403	5	28	-	-	-	-
1955	1029	-	30	-	-	-	-
1956	1166	-	8	-	-	-	-
1957	1729	-	75	1	2	-	-
1958	1405	1	98	2	-	-	-
1959	1298	-	52	10	-	-	-
1960	645	-	25	1	-	-	-
1961	729	-	-	3	-	-	19
1962	807	-	3	18	-	-	49
1963	820	-	30	42	-	-	33
1964	998	-	27	28	-	-	71
1965	884	-	37	35	-	-	133
1966	222	-	-	8	-	-	218
1967	11	-	-	-	-	-	99
1968	24	-	-	-	-	-	98
1969	19	-	-	-	-	-	42
1970	12	1	-	1	-	-	100
1971	-	-	-	-	-	-	135
1972	-	-	193	86	-	-	133
1973	-	-	-	55	-	-	98
1974	1	-	1	29	-	1	229
1975	16	-	2	7	-	-	868

Source: Bioassay, 1956-1984; Bioassay, 1956-1967; Bioassay, 1958-1986

An analysis of the available monitoring data suggests that CPP personnel exposures were chronic in nature. Evidence points to the conclusion that shift laboratory personnel were exposed to low levels of internal radioactivity for many years, at levels and to isotopes reflective or proportional to the levels and isotopes of the work performed during the period under evaluation in this report. Exposures recorded in the mid- and late-1970s were detected as a result of a newly-initiated routine bioassay program (NIOSH has access to documented evidence that the CPP radiation protection program had significantly improved by 1975). The potential for exposures to transuranics that had been separated from the mixed fission products makes it unlikely that exposures to alpha-emitters can be adequately reconstructed from January 1963 through December 1974.

Whole Body Counting Information and Available Data

Groups of individuals who worked continuously with contaminated materials were scheduled for whole-body counts by the Health & Safety Services secretary according to the 1963 schedule shown in Figure 7-1 (Source: McCaslin, 1963).

AED-366 1-42		STANDARD PRACTICES MANUAL	
PHILLIPS PETROLEUM COMPANY ATOMIC ENERGY DIVISION			
STANDARD PRACTICE NO. <u>6.2411</u>		APPENDIX D	
SUBJECT <u>CPP Whole Body Count Frequency Schedule</u>		DATE ISSUED <u>4/1/63</u> EXPIRES _____	
AREA <u>Health & Safety Branch</u>		PAGE NO. <u>i</u> OF <u>i</u>	
APPROVED BY _____		SUPERSEDES ISSUE <u>2/25/63</u> DATED _____	
<u>Group</u>	<u>Once/Year</u>	<u>Once/2 Year</u>	<u>No Count</u>
<u>CPP HP</u>			
HP Technicians	10		
Decont. Technicians & Issue Clerk	3		
Supv., Safety, Nurse		5	
<u>Maintenance</u>			
Mechanics	6		
Fitters	5		
Welders	2		
Machinist		1	
Janitors		3	
Supvs., Clerks, Sec.			7
<u>Instrument Maintenance</u>			
Instrument Technicians	11		
Supervisor			1
<u>Electrical Maintenance</u>			
Electricians		4	
Supervisor			1
<u>Operations</u>			
Shift Supervisors		5	
Foremen		4	
Operators	33		
Outside Area & Power Plant			14
Supv., Coords., Eng., Sec.			13
<u>Design Engineering</u>			
			14
<u>Analytical Chemistry</u>			
<u>Chemical Analysis</u>			
Chemists and Technicians	10		
Supervisors		6	
Analytical Dev.			13
Spectroscopy			11
Radio and Spec. Analysis		7	
Supervisors and Secretary			3
<u>Technical</u>			
			39
SUB-TOTAL	80	35	116
Count Frequency	7/mo.	1/mo.	
		<u>8/mo. Total</u>	

Figure 7-1: CPP Whole Body Count Frequency Schedule for 1963

Special analyses would be requested by the Health Physics sections when internal exposure was suspected due to events occurring in the plant. The Health and Safety section determined, based on job duties, which individuals would receive a termination whole-body count at the time of their termination physical examination (McCaslin, 1963).

Personnel exposures for specific functional groups at CPP increased as the plant aged due to increased equipment age and the activity of the fuels being processed. This resulted in increased direct maintenance. CPP exposures in excess of that normally permitted drew attention from the AEC and Allied Chemical Corporation (Rich, 1974). Despite the increasing potential for exposure, the monitoring frequency decreased from the 1963 schedule shown in Figure 7-1 to each individual receiving a whole-body count every four years (McCaslin, 1966). During this time, bioassay samples (fecal and urine) were collected and analyzed only when an exposure incident was suspected. Based on this review, it is possible that even a routine whole-body count would be inadequate to detect low-level exposures or exposures to alpha- or beta-emitters, much less an incident-based program. Within the incident-based program, the typical problems were being encountered in obtaining from exposed personnel the cooperation necessary to provide samples as requested, and to furnish all of the necessary information (Rich, 1974).

Increased potential for intake due to poor contamination control and inadequate personnel monitoring for exposures to transuranics separated from mixed fission products makes it unlikely that exposures to alpha emitters can adequately be reconstructed from January 1963 through December 1974. Significant programmatic improvements were identified and initiated in 1974 (ICPP HP Upgrade, 1971-1980).

NOTE: Based on a need to further evaluate the implementation of the CPP programmatic improvements discussed above, NIOSH has reserved the time period beginning January 1, 1975 for further evaluation.

Airborne Levels

The Health and Safety Division provided a fixed air monitoring network as part of the complete radiation monitoring program (Horan, 1959). A total of 32 continuous air monitors were used in all areas of CPP to detect airborne radioactivity. However, continuous monitoring of air activity in the cells was difficult to do in a representative manner; as a result, cell entry was made using complete respiratory protection until contamination levels were reduced to insignificant levels (Rich, 1974). The CPP Health Physics Manual required use of a filter-type respirator when airborne activity exceeded $1 \times 10^{-8} \mu\text{Ci}/\text{cm}^3$ for beta/gamma activity or $1 \times 10^{-11} \mu\text{Ci}/\text{cm}^3$ for alpha activity. An army assault-type mask was required when levels exceeded this by a factor of 10; positive-pressure air masks were required if there were levels higher by a factor of 1,000 (CPP HP Manual, 1952). There was no routine program for air sampling or monitoring in the Mass Spectrometry Lab at the time of the 1972 plutonium contamination incident (Malmstrom, 1972).

Permissible airborne concentration limits were documented in the Process and Laboratory Building Operating Manual (Irvine, 1954), as shown in Table 7-7.

Table 7-7: CPP Permissible Airborne Contamination Levels	
Radionuclide	Concentration ($\mu\text{Ci}/\text{cm}^3$ air)
Strontium-89	2×10^{-8}
Strontium-90	2×10^{-10}
Iodine-131	3×10^{-9}
Xenon-133	5×10^{-6}
Xenon-135	1.7×10^{-2}
Uranium (natural)	1.7×10^{-11}
Plutonium-239	2×10^{-12}
Fission Products	1×10^{-9}

Source: Irvine, 1954

An adequate evaluation of the chronic intake of radioactive materials without extensive bioassay samples can be made only by performing a more sensitive and detailed analysis of the filters removed from the air sampling devices (Rich, 1974). Beginning in August 1959, CAM filters from the Change Room in Building 602, the Access Corridor, the Sample Corridor, the Process Makeup Area, Room 212, and the Shift Control Lab were saved and counted for long-lived alpha activity (Willis, 1959).

Although a routine air monitoring program appears to have been in place at CPP, NIOSH has found very limited air sampling results. These results include:

- 569 samples taken in G and H Cells, the Remote Analytical Facility, and Building 602 during 1955 (G&H Air, 1955).
- 343 β/γ results and 794 alpha results from Process Makeup Area, Access Corridor, and the Solvent Burner during the time period from February 1957 to January 1960 (CPP Air, 1957-1960),
- 130 α/β results acquired using a Hi-Vol air sampler in the Solvent Burner area, and CAMs in Building 605, the Access Corridor, the Makeup Area, and the Operating Corridor during the time period from 1960 to 1961 (CPP Hi Vol Air, 1960-1961).

NIOSH has determined that these limited air monitoring results cannot be used to adequately reconstruct exposures to alpha-emitters from January 1963 through December 1974.

Alternative Data Sources for Bounding Internal Dose

The contamination control limits employed for the detection and control of released activity beyond the control boundaries related to: (1) instrumentation capabilities; and (2) the basic philosophy of acceptance of detectable contamination. The contamination control limits for alpha on plant surfaces, and particularly personnel, were set close to the MDA, so that any detectable contamination was a signal for preventive and follow-up evaluations and actions. From the onset of operations through the

end of the 1960s, control levels on smear surveys were set at 500 dpm β and 20 dpm α per 100 cm². From the 1970s to the termination of CPP operations, smear control levels were set at 300 dpm β and 20 dpm α per 100 cm² (CPP HP Manual, 1952). Table 7-8 provides information on CPP contamination monitoring.

Year	Surveys	Smears	Cases Requiring Cleaning	SRDB Ref ID
1953	1999	5571	-	138206
1954	11819	24111	-	138206
1955	11697	30623	-	138206
1956	18921	81756	-	138206
1957	13044	53874	637	88592
1958	22879	85661	1596	87078
1959	28699	100021	2382	87080
1960	21631	58089	988	138206
1961	19132	55823	511	138206
1962	16502	65749	453	138206
1963	23262	85082	700	138707
1964	32302	129352	1538	138206
1965	36914	139848	2512	139285
1966	34435	120019	1481	139194

In October 1974, the *Preliminary ICPP Health Physics Upgrade Program* report was published and delivered to management with the intention of identifying and reducing the inherent risks of ICPP operations (Rich, 1974). This report provided an overview of the total radiological control program at CPP and detailed the interrelationship of each aspect of the program. In the body of the report, an attempt was made in each of the listed categories to:

- describe conditions as they existed, with a description of any observed deficiencies
- list the goals for programmatic improvement, keeping in mind the "State-of-the-Art"
- outline the initial plans to correct any deficiencies identified
- provide a rough estimate of cost for manpower and equipment
- estimate the time required to complete that phase of the program.

Publication of this report marked the initiation of substantial changes in the radiological control program (Rich, 1979).

7.2.2.2 Methods for Bounding Operational Period Internal Dose for CPP

Despite an increasing potential for exposure, monitoring frequency decreased in 1966 so that each individual received a whole-body count every four years (McCaslin, 1966). During this time, bioassay samples (fecal and urine) were collected and analyzed only when an exposure incident was suspected. Based on NIOSH's review, it is possible that even a routine whole-body count would be inadequate to detect low-level exposures or exposures to alpha- or beta-emitters, much less an

incident-based program. Within the incident-based program, the typical problems were being encountered in getting the cooperation necessary from exposed personnel to obtain samples as requested and all necessary information (Rich, 1974). Increased potential for intake due to poor contamination control and inadequate personnel monitoring for exposures to transuranics separated from mixed fission products makes it unlikely that exposures to alpha emitters can adequately be reconstructed from January 1963 through December 1974.

Uranium

CPP was designed as a closed process, wherein dissolution and separation equipment were handled remotely. The first radionuclide-specific bioassay results located for CPP are uranium results. NIOSH has determined that it does not have sufficient information to adequately bound exposures to uranium from January 1, 1963 through December 31, 1974.

Neptunium

Prior to 1965, neptunium was disposed of in waste streams. During the neptunium separation campaigns that began in 1965, the potential for exposure to this element increased for workers who drew samples from the process streams, as well as for analytical staff, who measured the neptunium concentration in the storage tanks and process streams. Although low, there was a potential for workers to be exposed to neptunium during activities at the CPP. There was no routine monitoring program for neptunium intakes and it is likely that the incident-based monitoring program could have missed chronic, low-level exposures. NIOSH has determined that it does not have sufficient information to adequately bound exposures to neptunium from January 1, 1963 through December 31, 1974.

Plutonium

Prior to 1965, plutonium was considered an undesirable contaminant of the uranium product and was disposed of in waste streams. During the neptunium separation campaigns that began in 1965, the potential for exposure to plutonium increased for workers who drew samples from the process streams, as well as for analytical staff, who measured the plutonium concentration in the storage tanks and process streams. Although low, there was a potential for workers to be exposed to plutonium during activities at CPP. There was no routine monitoring program for plutonium intakes and it is notable that the incident-based monitoring program is known to have missed chronic, low-level exposures, as described in Section 5.4.2. NIOSH has determined that it does not have sufficient information to adequately bound exposures to plutonium from January 1, 1963 through December 31, 1974.

Fission Products

From the beginning of operations, bioassay results for fission products were used as an indicator of contamination control. For urine samples only analyzed for gross beta, gross gamma, and/or strontium radioactivity, NIOSH will assess missed Sr-90 and/or Cs-137 intakes in accordance with ORAUT-OTIB-0054 and ORAUT-OTIB-0060. Similarly, NIOSH will assess missed Cs-137 intakes when using *in-vivo* data in accordance with ORAUT-OTIB-0060. Based on the procedural information and the data on hand, NIOSH finds that it has adequate monitoring data to allow for

sufficiently accurate estimation of internal fission product doses for workers during the period from January 1, 1954 through December 31, 1974.

Barium/Lanthanum

The RaLa process campaign ran from 1957 to 1963, during which time, over a million curies of Ba-140 were recovered. The fuel elements used in the RaLa process were intensely radioactive because of the short time that had elapsed between removal from the reactor and processing. Recovery of La-140 was a complicated process completed in a specialized processing cell (L-Cell) in CPP-601. Safety measures included: isolation of the process behind a shielded viewing window, remote-handling manipulators, a periscope, and an intercom system installed in the vacant L-Cell to allow an operator to see and hear the work going on behind six feet of concrete shielding. The nature of the process makes it extremely unlikely that a worker would be exposed to these materials. NIOSH has found no indication that there were ruptures or leaks in the process shielding or equipment, and no indication of barium or lanthanum contamination outside the cell.

During RaLa runs, the CAM in the PM area near L-Cell was to be checked for possible airborne contamination. In addition, once each hour, an individual designated by the HP foreman was assigned to routinely check the following: (1) all RaLa piping in the PM-PO-PA areas for any change in radiation; and (2) all CAMs in CPP-601, CPP-604, and CPP-643 for any rise in air activity.

The intense radiation of the product (approximately 60,000 rem/hr at one meter) necessitated remote handling of product materials. At the conclusion of RaLa processing, the RaLa product was remotely placed in the shipping cask inside the cell. A physicist was required to be present when the L-Cell hatch cover was removed, the shipping cask was removed from the cell, and the cask prepared for shipment. Full-face masks equipped with carbon filters were required during this part of the operation, and after the RaLa shipping container left the PM area, the physicist took smear samples of the PM area floor in the vicinity of L-Cell.

The air from the cell was required to be monitored continuously whenever the cell top was open and during decontamination. Any cell entry prior to or during decontamination required airline respirators or full-face air-purifying masks. After decontamination was complete and the air levels were measured to be less than 10 RCG potential, carbon respirators with static web filters were permitted for cell entry (HP Regs, 1963).

Lanthanum-140 decays by beta emission and, in doing so, emits several photons that should be detectable via whole-body counting. In addition, the presence of La-140 would have been detected during a urinalysis that was analyzed for gross gamma or beta counting. Based on the process information and the data on hand, NIOSH finds that it has adequate monitoring data to allow for sufficiently accurate estimation of barium-140 or lanthanum-140 exposures for workers during the period from January 1, 1954 through December 31, 1974.

Thorium

Two thorium slugs were dissolved in 1957. Each of these had a total mass of 1730 g, with 78 grams being aluminum cladding. Separation of the uranium was performed in a glove box and small samples were transferred to the Mass Lab for analysis, minimizing the exposure potential.

Six slugs were dissolved in 1961. Each slug had a mass of about 1730 g; they were dissolved and prepared for analysis in the Multicurie Cell. Manipulations within the cell were made with a pair of master-slave manipulators, minimizing the chance for an intake.

With a specific activity of 1.1×10^{-7} Ci/g, there is no apparent plausible scenario that would have allowed for the ingestion or inhalation of an appreciable amount during either of the above campaigns. Therefore, additional analysis of thorium, beyond the bounding approaches for other radionuclides that has been performed for this evaluation, has not been performed. Specific analyses for thorium will be addressed on a case-by-case basis if a plausible exposure scenario is identified or presented.

Rare Gases

Xenon and krypton are readily-diffusible gases that are neither used nor produced by the body. Most of the xenon or krypton gas that enters the circulation from a single breath is returned to the lungs and exhaled after a single pass through the peripheral circulation; they are essentially inert. Radiation doses from inhaling or ingesting krypton or xenon are small compared to the dose from external radiation, such as could occur in a cloud of gas. Thus, internal exposures due to these gases will not be considered further in this report.

Iodine

The RaLa process ran from February 1957 to August 1963. Because of a cooling time of only two days (compared to the 90-120 days cooling normally provided for most other fuel elements before reprocessing), the RaLa process contributed large quantities of the fission product iodine to the process off-gas. The virtually-complete containment of iodine was a major objective in the design of the RaLa process. However, the first processing of a fully-irradiated fuel element disclosed serious deficiencies in the iodine-containment measures.

An upgraded RaLa Off-Gas system contained charcoal beds for removing radioiodine and a gas holder for storing the noble gases during decay (Waste Management, 1974). This system was able to remove gaseous iodine with a 99.9% efficiency, but was still limited in its ability to remove iodine-bearing dusts and mists (I-131 Containment, 1961). Site-wide routine samples were initially analyzed only for gross alpha and beta, with isotopic analysis performed only if activity was discovered in the sample - although capabilities existed for analyses for specific isotopes such as Pu-239, Sr-90, Co-60, and I-131 in body excreta, water, and air samples. Beginning in May 1957, the Division started requesting gross-gamma counts on all urine samples submitted by CPP personnel in an effort to detect the potential uptake of iodine from fresh fuel (HP Monthly Reports, 1957). NIOSH intends to use these urinalysis data to reconstruct doses to the exposed workers.

Tritium

Historical records on INL tritium exposures are sparse, although it appears that limited environmental monitoring began in 1960 (Horan, 1961). The most important tritium source term appears to be HTO as a by-product waste material from processing alloy fuels at CPP. Sampling and analysis were consistent with methods used at other AEC facilities. In 1974, INL reported a detection limit of 0.6 kBq/L for tritium in urine using liquid-scintillation counting methods with a 10-minute counting time. The year 1974 is also the first year for which NIOSH has tritium-specific bioassay. This does not mean that tritium bioassays were not conducted, however. Documentation points to urine samples being analyzed for tritium as early as 1968 (Puphal, 1994). However, the results of *in-vivo* and *in-vitro* bioassay were not included in an individual's file unless a dose assessment was made from a positive result (Tiger Team, 1991).

As described in Section 5.2.2, tritium was likely only present where mixed fission and activation products were present. In addition, the source term for tritium and its ability to contribute to the workers' internal doses was likely insignificant compared to the workers' exposures to mixed fission and activation products because the process equipment and enclosed cell structure limited the potential for tritium exposure. Based on this information NIOSH feels it can adequately bound tritium exposures using the presence of mixed fission products as an indicator of the presence of tritium.

7.2.3 Evaluation of Bounding Internal Doses for TAN

The philosophy of TAN's internal dose monitoring program established a routine monitoring and control program based on mixed fission products as the controlling radionuclides. That is, if the mixed fission products were controlled to permissible levels, the alpha hazards would be adequately controlled. However, potential exceptions to this were noted in Section 5.2.3.

TAN workers participated in bioassay programs for potential intakes of mixed fission products by either urinalysis or whole-body counts, either routinely or when workplace indicators (e.g., elevated airborne radioactivity, contamination event, positive nasal smear) indicated that an intake may have occurred. When workplace indicators indicated that an intake may have occurred, "special" (non-routine) bioassay would be requested by TAN Health Physics.

As indicated in Section 5.2.3, the categories of radionuclides at TAN included: mixed fission and activation products, radioiodines, radioactive noble gases, plutonium, neptunium, uranium, other actinides, and other radionuclides.

A tabular representation of the feasibility of reconstructing doses is presented in Table 7-9, in which the dark green cells with an "F" indicate reconstructions that are feasible, the light green cells with a "C" indicate reconstructions that are feasible but a mixed-fission-product co-worker model is needed, and the yellow cells with an "R" indicate that years for that particular exposure type are reserved for further evaluation. The rationale for these feasibility designations is presented in the following subsections.

Table 7-9: Feasibility Summary for TAN (1955-1970)

Exposure Source	Years															
	55	56	57	58	59	60	61	62	63	64	65	66	67	68	69	70
Mixed Fission & Activation Products	F	F	F	F	F	F	F	F	F	F	F	F	C	C	C	C
Radioiodines	F	F	F	F	F	F	F	F	F	F	F	F	C	C	C	C
Actinides with MFP Present	F	F	F	F	F	F	F	F	F	F	F	F	C	C	C	C
Uranium without MFP Present	F	F	F	F	F	F	R	R	R	R	R	R	R	R	R	R
Other Radionuclides	F	F	F	F	F	F	F	F	F	F	F	F	C	C	C	C
External Photon and Electron	F	F	F	F	F	F	F	F	F	F	F	F	F	F	F	F
External Neutron	F	F	F	F	F	F	F	F	F	F	F	F	F	F	F	F

F = Dose reconstructions are feasible.

C = Dose reconstructions are feasible but a mixed fission product co-worker model is needed.

R = Reserved for further evaluation.

7.2.3.1 Evaluation of Bounding Process-Related Internal Doses for TAN

Urinalysis Information and Available Data

From September 1955 through January 1970, approximately 9,467 urinalyses for gross beta radioactivity, strontium radioactivity, and/or gross gamma radioactivity were performed for TAN workers in order to detect intakes of mixed fission and activation products. The urinalyses for gross gamma radioactivity could also detect intakes of radioiodines and other gamma-emitting radionuclides. The urinalyses for beta-gamma radioactivity could also detect intakes of other non-volatile beta-emitting radionuclides.

During 1956, 1962–1966, and 1970, approximately 111 urine samples were specifically analyzed for uranium. In May 1958, six urine samples were specifically analyzed for iodine-131. On October 16, 1962, the urine samples of several TAN workers were analyzed for thorium intakes. Only two urine samples from the same TAN worker were specifically analyzed for plutonium, one in 1963 and one in 1964. On November 13, 1956, one urine sample was analyzed for Po-210.

No urinalysis results were found for the other radionuclides at TAN.

Whole Body Counting Information and Available Data

Based on NIOSH's review of the available data, from July 1961 through 1975, whole-body counts were performed for TAN workers. Furthermore, during the period from July 1961 through January 1970, whole-body counts transitioned into being the primary bioassay method for detecting intakes of fission and activation products in TAN workers. Whole-body counts could also detect intakes of radioiodines and other gamma-emitting radionuclides. The TAN Whole Body Count Frequency Schedule from 1963 indicates that 22.3% of the TAN workers received whole-body counts every six months, 21.6% received annual whole-body counts, and 56.1% did not receive any whole-body counts (McCaslin, 1963). Based on the worker categories provided in that schedule, the frequencies were based on the workers' potential to receive internal dose (McCaslin, 1963). In addition, all

terminations requiring a physical examination, as determined by the Health & Safety sections, also required a whole-body count (McCaslin, 1963).

Airborne Levels

A limited amount of air monitoring data was captured for the TAN facilities for the years 1962-1970 (CAM 1967-1970, CAM, 1962-1963, CAM, 1963-1964, CAM, 1964-1967).

Alternative Data Sources for Bounding Internal Dose

A limited amount of contamination survey data was captured for the TAN facilities for the years 1964–1968 (TAN Monitoring, 1963).

7.2.3.2 Methods for Bounding Operational Period Internal Dose for TAN

Mixed Fission and Activation Products

The potential intakes of mixed fission and activation products for monitored and unmonitored TAN workers can be estimated using the approaches described in ORAUT-TKBS-0007-5. For urine samples analyzed for gross beta, gross gamma, and/or strontium radioactivity, NIOSH will assess Sr-90 and/or Cs-137 intakes in accordance with ORAUT-TKBS-0007-5 and ORAUT-OTIB-0060. For whole body counts, NIOSH will assess Cs-137 intakes in accordance with ORAUT-TKBS-0007-5 and ORAUT-OTIB-0060. In accordance with the guidance in ORAUT-OTIB-0054, NIOSH will use Sr-90 and/or Cs-137 intakes to estimate the intakes of the other mixed fission and activation products that may have been present, unless a bioassay result was available for a specific radionuclide. In the event that a bioassay result was available for a specific radionuclide, NIOSH will use that result in lieu of the ORAUT-OTIB-0054 approach.

Based on the procedural information and the data on-hand, NIOSH finds that it has adequate monitoring data to allow for sufficiently accurate estimation of internal doses attributable to mixed fission and activation products for TAN workers during the period from 1955 through 1970.

Radioiodines

The potential intakes of radioiodines without the other mixed fission products present can be estimated for monitored and unmonitored TAN workers using the approaches described in ORAUT-TKBS-0007-5. Urine samples analyzed for gross gamma radioactivity and whole-body counts can be used to assess any potential intakes of radioiodines without the other mixed fission products present. Based on the availability of the gross gamma urine sample data and whole-body count data for TAN workers, NIOSH finds that it has adequate monitoring data to allow for sufficiently accurate estimation of internal doses attributable to radioiodines for TAN workers during the period from August 1958 through 1970.

Radioactive Noble Gases

Because radioactive noble gases do not represent a significant internal exposure concern, NIOSH finds there is no need to assess the internal doses attributable to radioactive noble gases.

Actinides with Mixed Fission Products Present

The majority of the actinides at TAN were present with mixed fission products. The potential intakes of actinides when mixed fission products were present can be estimated using the approach described in Section 5.5.2 of ORAUT-TKBS-0007-5. Based on that approach, actinide intakes are estimated by multiplying the assessed Sr-90 and/or Cs-137 intakes by actinide-to-Sr-90 and/or actinide-to-Cs-137 ratios.

Based on the procedural information and the data on-hand, NIOSH finds that it has adequate monitoring data to allow for sufficiently accurate estimation of internal doses attributable to actinides when mixed fission products were present for TAN workers during the period from 1955 through 1970.

Uranium without Mixed Fission Products Present

NOTE: During research for the SEC-00219 evaluation report, it was discovered that uranium contamination without mixed fission products was present in the Fuel Storage Vaults of the TAN-607 Building and the TAN-615 Building. Further investigation is needed to determine the source of the contaminants, the beginning and end dates for the presence of the uranium contamination, and whether the exposures to that uranium can be bounded.

Other Radionuclides

Even though none of the bioassay methods at TAN could detect H-3 and/or C-14, these two radionuclides were likely only present where mixed fission and activation products were present. Furthermore, the source terms for H-3 and C-14 and their ability to contribute to the workers' internal doses were likely insignificant compared to the workers' exposures to mixed fission and activation products.

The potential intakes of Na-24 can be estimated for monitored and unmonitored TAN workers using the guidance provided in Section 5.5.8 of ORAUT-TKBS-0007-5. Urine samples analyzed for gross gamma radioactivity and whole-body counts can be used to assess any potential intakes of Na-24. Based on the availability of the gross beta urine sample data, gross gamma urine sample data, and whole-body count data for TAN workers, NIOSH finds that it has adequate monitoring data to allow for sufficiently accurate estimation of internal doses attributable to Na-24 for TAN workers during the period from 1955 through 1970.

7.2.4 Evaluation of Bounding Internal Doses for Misc. Reactor Areas

The Miscellaneous Reactor Areas' internal dose monitoring program established a routine monitoring and contamination control program based on mixed fission products as the controlling radionuclides. Workers participated in bioassay programs for potential intakes of mixed fission products by either urinalysis and/or whole-body counts. Participation was on a routine basis or as required by radiological indicators. When workplace indicators indicated that an intake may have occurred, "special" (non-routine) bioassay would be requested by the area Health Physics staff.

A tabular representation of the feasibility of reconstructing doses is presented in Table 7-10, in which the dark green cells with an "F" indicate reconstructions that are feasible, the light green cells with a "C" indicate reconstructions that are feasible but a mixed-fission-product co-worker model is needed, and the yellow cells with an "R" indicate that years for that particular exposure type are reserved for further evaluation. The rationale for these feasibility designations is presented in the following subsections.

Exposure Source	Years															
	55	56	57	58	59	60	61	62	63	64	65	66	67	68	69	70
Mixed Fission Products	F	F	F	F	F	F	F	F	F	F	F	F	C	C	C	C
Plutonium/Neptunium	F	F	F	F	F	F	F	F	F	F	F	F	C	C	C	C
Uranium	F	F	F	F	F	F	F	F	F	F	F	F	C	C	C	C
Other	F	F	F	F	F	F	F	F	F	F	F	F	C	R	C	C
Photon	F	F	F	F	F	F	F	F	F	F	F	F	F	F	F	F
Neutron	F	F	F	F	F	F	F	F	F	F	F	F	F	F	F	F

F = Dose reconstructions are feasible.

C = Dose reconstructions are feasible but a mixed fission product co-worker model is needed.

R = Reserved for further evaluation.

7.2.4.1 Evaluation of Bounding Process-Related Internal Doses for Misc. Reactor Areas

Urinalysis Information and Available Data

The Misc. Reactor Areas was a "proof of principle" area where various reactor projects were built and operated. Potential internal exposure to radioactive materials from operation and maintenance activities was recognized and monitored. The principal source of internal radiation doses for members of the class working in the Misc. Reactor Facilities was mixed fission products, although there was limited exposure potential to some exotic radionuclides, noble gases, iodine, and uranium, as discussed in Section 5.2.4.

The Misc. Reactor Area routine urinalysis program was based on gross beta and gamma analyses of urine samples. Positive measurements of interest would initiate identification of the contaminant of interest. Incident-driven or special urinalysis was also performed if an internal exposure was suspected from radiological conditions (Special HP Services, 1968; Personal Communication 2014i). Urinalysis data are available for the Misc. Reactor Areas during the years of operations, except for 1967-1970. The lack of *in-vitro* bioassay data between these years was due to transition to *in-vivo* measurements with subsequent decreases in *in-vitro* bioassay (McCaslin, 1966). Table 7-11 provides internal monitoring results for the Misc. Reactor Areas.

Table 7-11: Miscellaneous Reactor Area-Specific Internal Monitoring Results						
Year	SPERT		OMRE		ARA	
	β/γ urinalysis	<i>In-vivo</i>	β/γ urinalysis	<i>In-vivo</i>	β/γ urinalysis	<i>In-vivo</i>
1954	-	-	-	-	-	-
1955	3	-	-	-	-	-
1956	80	-	-	-	-	-
1957	124	-	69	-	-	-
1958	122	-	169	-	-	-
1959	76	-	99	-	81	-
1960	64	-	140	-	90	-
1961	150	4	43	22	413	48
1962	108	9	308	5	12	55
1963	48	27	108	75	52	63
1964	167	48	-	-	9	12
1965	142	68	-	-	-	2
1966	130	16	-	-	-	-
1967	-	19	-	-	-	-
1968	-	14	-	-	-	1
1969	-	-	-	-	-	-
1970	-	17	-	-	-	11

Source: Bioassay, 1956-1984; Bioassay, 1956-1967; Bioassay, 1958-1986; WBC1, 1961-1977; WBC2, 1963-1995; WBC3, 1981-1994; WBC4, 1979-1995; WBC5, 1973-1996

Whole Body Counting Information and Available Data

Table 7-11 presents both *in-vivo* and *in-vitro* data for the Misc. Reactor Areas. As with *in-vitro* bioassay, event-driven *in-vivo* measurements would be performed if deemed necessary by Health Physics. Of the Misc. Reactor Areas, only SPERT had a counting frequency prescribed by Health and Safety, shown in Table 7-12 (McCaslin, 1963).

Table 7-12: SPERT Whole Body Count Monitoring Frequency			
Group	Semiannual	Annual	Not Required
HP Technicians	4	1	-
SPERT I	4	4	-
SPERT II	5	7	-
SPERT III	5	1	-
SPERT IV	5	4	-
General Area	-	8	54

Source: McCaslin, 1963

Airborne and Contamination Levels

Air monitoring and contamination smear programs were used in the Misc. Reactor Areas to control personnel exposures to airborne radioactivity and surface contamination. Contamination smear programs were well documented in monthly Health Physics reports (SPERT HP Reports, 1959). Continuous air monitors were used in all reactor facilities. The SPERT reactors used a single CAM on the stack exhaust to measure air effluents which were reported in monthly radioactive waste reports. Airborne concentrations tended to be in the μCi -to- mCi range except during transient testing. During months when transient tests were performed, airborne releases were much higher but the composition of the releases was of fresh fission products with short half-lives. In addition, controlled access and favorable meteorological conditions were required for testing (SABER, 1990). Examples of the use of CAMs in the ARA, OMRE, and SPERT reactors are available (SL-1 Safety, 4Q1959; OMRE HP Survey, 1962-1963; SPERT, 1957, respectively). NIOSH does not intend to use air monitoring and contamination results to bound potential internal doses.

7.2.4.2 Methods for Bounding Operational Period Internal Dose for Misc. Reactor Areas

Fission Products

For the Misc. Reactor Areas, mixed fission and activation products have always been present in contaminants. For urine samples only analyzed for gross beta, gross gamma, and/or strontium radioactivity, NIOSH will assess missed Sr-90 and/or Cs-137 intakes in accordance with ORAUT-OTIB-0054 and ORAUT-OTIB-0060. Similarly, NIOSH will assess missed Cs-137 intakes when using *in-vivo* data in accordance with ORAUT-OTIB-0060. Based on the procedural information and the data on-hand, NIOSH finds that it has adequate monitoring data to allow for sufficiently accurate estimation of internal fission product doses for workers during the period from January 1, 1955 through December 31, 1970.

Other Radionuclides

As discussed, the primary exposure source at the Misc. Reactor Areas was fission products, and any other radionuclides were present with mixed fission products. The potential intakes of other radionuclides when mixed fission products were present (as indicated by data in personnel records) can be estimated on a case-by-case basis using the approach described in ORAUT-TKBS-0007-5. Based on the procedural information and the data on-hand, NIOSH finds that it has adequate monitoring data to allow for sufficiently accurate estimation of internal doses attributable to other radionuclides for Misc. Reactor Area workers during the period from January 1, 1955 through December 31, 1970.

NOTE: In 1968, the ARA hot cell was extensively modified for work separating Pa-233, a high-specific-activity alpha-emitter. Modifications included upgrades to the ventilation system and addition of isolation boxes for the Pa-233. ARA-I is being reserved for 1968 for further evaluation of the separation of Pa-233 that occurred in the hot cells.

7.2.5 Evaluation of Bounding Internal Doses for CFA

The Central Facilities Area's internal dose monitoring program established a routine monitoring and contamination control program based on mixed fission products as the controlling radionuclides. Workers participated in bioassay programs for potential intakes of mixed fission products by either urinalysis and/or whole-body counts. Participation was on a routine basis or as required by radiological indicators. When workplace indicators indicated that an intake may have occurred, "special" (non-routine) bioassay would be requested by the area Health Physics staff.

A tabular representation of the feasibility of reconstructing doses is presented in Table 7-13, in which the dark green cells with an "F" indicate reconstructions that are feasible, and the light green cells with a "C" indicate reconstructions that are feasible but a mixed-fission-product co-worker model is needed. The rationale for these feasibility designations is presented in the following subsections.

Table 7-13: Feasibility Summary for Central Facilities Area (1949-1970)																						
Exposure Source	Years																					
	49	50	51	52	53	54	55	56	57	58	59	60	61	62	63	64	65	66	67	68	69	70
Mixed Fission Products	F	F	F	F	F	F	F	F	F	F	F	F	F	F	F	F	F	F	C	C	C	C
Plutonium/Neptunium	F	F	F	F	F	F	F	F	F	F	F	F	F	F	F	F	F	F	C	C	C	C
Uranium	F	F	F	F	F	F	F	F	F	F	F	F	F	F	F	F	F	F	C	C	C	C
Other	F	F	F	F	F	F	F	F	F	F	F	F	F	F	F	F	F	F	C	C	C	C
Photon	F	F	F	F	F	F	F	F	F	F	F	F	F	F	F	F	F	F	F	F	F	F
Neutron	F	F	F	F	F	F	F	F	F	F	F	F	F	F	F	F	F	F	F	F	F	F

F = Dose reconstructions are feasible.

C = Dose reconstructions are feasible but a mixed fission product co-worker model is needed.

7.2.5.1 Evaluation of Bounding Process-Related Internal Doses for CFA

Urinalysis Information and Available Data

The Central Facilities Area provided support services to the rest of INL. The primary internal exposure concerns would have been from the CF-699 Laundry facility and transportation support for radioactive waste shipments. The principal source of internal radiation doses for members of the class working in the CFA was mixed fission and activation products, although there was limited exposure potential to uranium, as discussed in Section 5.2.5.

The Health Services Laboratory was located in the CFA. The laboratory was part of AEC Health and Safety Technical Services and provided radiochemical analyses of body excreta samples and *in-vivo* measurements for gamma-emitting radionuclides. Also located in CFA was the CF-603 medical dispensary where *in-vitro* samples could be delivered (due to its central location). Baseline, termination, and excreta samples were often submitted at CF-603. Facility codes for CFA were frequently used for *in-vitro* samples and *in-vivo* measurements although the worker was not assigned to CFA. Consequently, a disproportionately high number of results are attributed to CFA. The data are reported in Table 7-14.

Table 7-14: Central Facilities Area-Specific Internal Monitoring Results						
Year	β/γ urinalysis	U urinalysis	Sr urinalysis	I urinalysis	Pu urinalysis and fecal	<i>In-Vivo</i>
1953	4	1	1	-	-	-
1954	196	7	-	-	-	-
1955	410	2	-	-	-	-
1956	386	-	-	-	-	-
1957	632	-	-	29	2	-
1958	303	12	-	10	-	-
1959	953	-	-	10	-	-
1960	1225	-	17	9	-	-
1961	1679	1	433	-	-	110
1962	1277	-	793	-	-	284
1963	1146	-	360	-	5	356
1964	1177	-	804	-	9	364
1965	1299	1	625	-	2	452
1966	330	-	432	-	-	313
1967	111	10	263	-	-	80
1968	-	-	-	-	-	101
1969	-	-	-	-	-	84
1970	55	3	-	-	-	105

Source: Bioassay, 1956-1984; Bioassay, 1956-1967; Bioassay, 1958-1986; WBC1, 1961-1977; WBC2, 1963-1995; WBC3, 1981-1994; WBC4, 1979-1995; WBC5, 1973-1996

Whole Body Counting Information and Available Data

Table 7-14 presents *in-vivo* and *in-vitro* bioassay data for the CFA. As with *in-vitro* bioassay, event-driven *in-vivo* measurements would be performed if deemed necessary by Health Physics. The CFA was not on a prescribed whole-body counting schedule like TRA, CPP, TAN and SPERT (McCaslin, 1963).

Airborne and Contamination Levels

Air monitoring and contamination smear programs were used in the CFA to control personnel exposures to airborne radioactivity and surface contamination. Contamination controls in the CF-699 Laundry included radiation monitors, a monitoring table for laundered clothing, and a CAM. The radiation monitor was located above the laundry receiving door and set to alarm at 2 mR/hr (Savignac, 1961). The Laundry monitoring table employed eight GM tubes and two scaling units that allowed it to distinguish between contamination spots vs. distributed contamination on clothing. A CFA health physicist routinely checked the CF-699 monitoring equipment and was responsible for responding to alarms. The CFA cafeteria was also routinely surveyed and smeared (CFA HP Logs, 1965-1966).

CFA Health Physics monthly reports provide summary data on the number of smears taken, number of special air samples, and the number of vehicle checks for contamination. Also provided are the numbers of on-site and off-site radioactive shipments (Savignac, 1961; Johnson, 1961). Analyses of sludge from the CF-674 Sewage Treatment Plant, to which the CF-699 Laundry facility was the primary contributor, identified mixed fixed products, such as Co-60, Zr-95, Nb-95, Cs-137, and Ce-144 (Savignac, 1961). NIOSH does not intend to use air monitoring or contamination results to bound potential internal doses.

7.2.5.2 Methods for Bounding Operational Period Internal Dose for CFA

Fission Products

For the CFA, mixed fission and activation products were the internal dose hazards of concern. For urine samples only analyzed for gross beta, gross gamma, and/or strontium radioactivity, NIOSH will assess missed Sr-90 and/or Cs-137 intakes in accordance with ORAUT-OTIB-0054 and ORAUT-OTIB-0060. Similarly, NIOSH will assess missed Cs-137 intakes when using *in-vivo* data in accordance with ORAUT-OTIB-0060. Based on the procedural information and the data on-hand, NIOSH finds that it has adequate monitoring data to allow for sufficiently accurate estimation of internal fission product doses for workers during the period from January 1, 1953 through December 31, 1970. Prior to 1953, NIOSH will assess internal dose in accordance with ORAUT-OTIB-0033.

Other Radionuclides

As discussed, the primary exposure source at the CFA was fission products and any other radionuclides present with mixed fission products. The potential intakes of other radionuclides when mixed fission products were present (as indicated by data in personnel records) can be estimated on a case-by-case basis using the approach described in ORAUT-TKBS-0007-5.

Based on the procedural information and the data on-hand, NIOSH finds that it has adequate monitoring data to allow for sufficiently accurate estimation of internal doses attributable to other radionuclides for CFA workers during the period from January 1, 1953 through December 31, 1970.

7.2.6 Evaluation of Bounding Internal Doses for the Burial Ground

The Burial Ground’s internal dose monitoring program was based on a strict contamination control program with entry and exit monitoring. With the exception of Rocky Flats waste, mixed fission products were considered the controlling radionuclides. When workplace indicators indicated that an intake may have occurred, “special” (non-routine) bioassay would be requested by the area Health Physics staff.

A tabular representation of the feasibility of reconstructing doses is presented in Table 7-15, in which the dark green cells with an “F” indicate reconstructions that are feasible, the light green cells with a “C” indicate reconstructions that are feasible but a mixed-fission-product co-worker model is needed, and the yellow cells with an “R” indicate that years for that particular exposure type are reserved for further evaluation. The rationale for these feasibility designations is presented in the following subsections.

Table 7-15: Feasibility Summary for the Burial Ground (1952-1970)																			
Exposure Source	Years																		
	52	53	54	55	56	57	58	59	60	61	62	63	64	65	66	67	68	69	70
Mixed Fission Products	F	F	F	F	F	F	F	F	F	F	F	F	F	F	F	C	C	R	R
Plutonium/Neptunium	F	F	F	F	F	F	F	F	F	F	F	F	F	F	F	C	C	R	R
Uranium	F	F	F	F	F	F	F	F	F	F	F	F	F	F	F	C	C	R	R
Other	F	F	F	F	F	F	F	F	F	F	F	F	F	F	F	C	C	R	R
Photon	F	F	F	F	F	F	F	F	F	F	F	F	F	F	F	F	F	F	F
Neutron	F	F	F	F	F	F	F	F	F	F	F	F	F	F	F	F	F	F	F

F = Dose reconstructions are feasible.

C = Dose reconstructions are feasible but a mixed fission product co-worker model is needed.

R = Reserved for further evaluation.

7.2.6.1 Evaluation of Bounding Process-Related Internal Doses for the Burial Ground

Urinalysis and Whole Body Counting Information and Available Data

The Burial Ground served as a solid radioactive waste disposal area for INL-generated solid waste, an interim waste burial facility for the western United States (Hayden, 1961), and Rocky Flats Plant waste beginning in 1954. The principal source of internal radiation doses for members of the class working at the Burial Ground was mixed fission and activation products, although there was exposure potential to plutonium from Rocky Flats waste, as discussed in Section 5.2.6. Any potential exposure to exotic radionuclides would be dominated by mixed fission product exposures at the Burial Ground.

Responsibility for the Burial Ground during the period of this evaluation resided with the CFA Health Physicist. A pool of workers known as “yardmen” comprised the work force that emplaced waste at the Burial Ground and worked out of CFA during those work evolutions. The *in-vitro* and *in-vivo* measurements for monitoring at the Burial Ground are included in Table 7-14 in Section 7.2.5.1.

Review of worker names on SWPs indicate that, at a minimum, some workers were monitored by bioassay, although it is possible that the monitoring was due to work activities in other areas. Special bioassay also exists, but the results could not be directly related to a contamination event at the Burial Ground. Requests for incident or non-routine bioassay would be made by the CFA Health Physicist.

Airborne and Contamination Levels

Responsibility for the overall operation of the Burial Ground resided with the CFA Health Physicist (Hayden, 1962). These responsibilities also included preparation of monthly reports, which included the number of off-site and on-site shipments by area and curie content. Examples are available (Hueter, 1963; Savignac, 1963; Sauvignac, 1963a; Hazards Control Qtr, 1965). Waste disposal at the Burial Ground required the presence of a health physicist. A review of Burial Ground SWPs from January 1962 to December 1964 indicate the level of monitoring that was required for certain work evolutions. Examples include personal survey upon completion of work, hand and shoe counts, and the level (continuous or intermittent) of health physics coverage (SWP, 1962-1964).

Table 7-16 presents the waste burial schedule for Rocky Flats Plant waste from February through August 1963. It is representative of the waste burial practices for Rocky Flats waste sent to INL for burial. Of note is that burial of Rocky Flats waste was performed only for a limited number of days each month.

Table 7-16: Example of Rocky Flats Waste Burial Schedule, February-August 1963			
Burial Summary Report	Ft³ Buried	No. of Pieces	Date Buried
February 1963	3542	^a 481	February 1, 1963
February 1963	2352	320	February 15, 1963
March 1963	3289	405	March 1, 1963
March 1963	3395	462	March 15, 1963
March 1963	3426	466	March 22, 1963
March 1963	3022	340	March 29, 1963
April 1963	3881	46	April 19, 1963
April 1963	4121	43	April 26, 1963
May 1963	2272	309	May 6, 1963
May 1963	2411	328	May 10, 1963
May 1963	2749	374	May 17, 1963
May 1963	3293	448	May 24, 1963
June 1963	3292	448	June 7, 1963
June 1963	3277	448	June 14, 1963
June 1963	4446	238	June 21, 1963
June 1963	4332	48	June 28, 1963
July 1963	4270	55	July 5, 1963
July 1963	3161	430	July 12, 1963
July 1963	2866	390	July 19, 1963
August 1963	3287	449	August 9, 1963
August 1963	2301	313	August 16, 1963
August 1963	3241	441	August 23, 1963
August 1963	4466	549	August 30, 1963

Source: Waste Shipments, Feb1963; Waste Shipments, Mar1963; Waste Shipments, Apr1963; Waste Shipments, May1963; Waste Shipments, Jun1963; Waste Shipments, Jul1963; Waste Shipments, Aug1963; Waste Shipments, Nov1963

^a Estimated – record illegible

7.2.6.2 Methods for Bounding Operational Period Internal Dose for the Burial Ground

NOTE: In late 1969, some experimental equipment that was accidentally buried in Pit 1 was retrieved; this marked the first time in the history of the Burial Ground that buried waste was deliberately exhumed. Further NIOSH evaluation is required of the personnel monitoring data for waste-retrieval activities, necessitating reservation of the Burial Ground from 1969 forward.

Mixed Fission and Activation Products

For the Burial Ground, mixed fission and activation products were the primary internal dose hazards of concern. For urine samples only analyzed for gross beta, gross gamma, and/or strontium radioactivity, NIOSH will assess missed Sr-90 and/or Cs-137 intakes in accordance with ORAUT-OTIB-0054 and ORAUT-OTIB-0060. Similarly, NIOSH will assess missed Cs-137 intakes when using *in-vivo* data in accordance with ORAUT-OTIB-0060. Based on the procedural information and the data on-hand, NIOSH finds that it has adequate monitoring data to allow for sufficiently accurate estimation of internal fission product doses for workers during the period from January 1, 1953

through December 31, 1968. Prior to 1953, NIOSH will assess internal dose in accordance with ORAUT-OTIB-0033.

Plutonium

The radiological monitoring program at the Burial Ground included the presence of a health physicist, safe work permits for all waste disposals, personnel surveys upon completion of work, air monitoring, and decontamination of vehicles at CPP if they were found to be contaminated. This defense-in-depth approach was adequate to ensure that unmonitored intakes of plutonium did not occur.

As discussed, the primary exposure source at the Burial Ground was fission products and any other radionuclides present with mixed fission products. The potential intakes of other radionuclides when mixed fission products were present (as indicated by data in personnel records) can be estimated on a case-by-case basis using the approach described in ORAUT-TKBS-0007-5.

Based on the procedural information and the data on-hand, NIOSH finds that it has adequate monitoring data to allow for sufficiently accurate estimation of internal doses attributable to other radionuclides for CFA workers during the period from January 1, 1953 through December 31, 1968.

7.2.7 Internal Dose Reconstruction Feasibility Conclusion

The 1967-1970 period at INL has been identified as an area requiring analysis for the entire site due to a change in bioassay protocol during that period. While a data-sufficiency issue has not been identified (with the exception of the period from 1963-1974 at CPP and the reserved sections/areas of this report), NIOSH has determined that a bioassay co-worker model is needed to support reconstructing internal dose for the post-1966 period at INL.

NIOSH has come to the following conclusions regarding the feasibility of internal dose reconstruction for the six operating areas under evaluation for this report:

- Test Reactor Area: NIOSH concludes that the available bioassay data are such that internal radiation doses received from intakes of fission products and actinides can be completely reconstructed with sufficient accuracy for the Test Reactor Area at INL from 1953 through 1970.
- Chemical Processing Plant: NIOSH concludes that the available bioassay data are such that internal radiation doses received from intakes of fission products and other radionuclides can be completely reconstructed with sufficient accuracy for the Chemical Processing Plant at INL from 1953 through 1962. Increased potential for intake due to poor contamination control and inadequate personnel monitoring for exposures to transuranics separated from mixed fission products makes it unlikely that exposures to alpha emitters can adequately be reconstructed from January 1963 through December 1974.

NOTE: Based on a need to further evaluate the implementation of the CPP programmatic improvements, NIOSH has reserved the time period beginning January 1, 1975 for further evaluation.

- Test Area North: Based on the availability of the gross beta urine sample data, gross gamma urine sample data, and whole-body count data for TAN workers, NIOSH finds that it has adequate monitoring data to allow for sufficiently accurate estimation of internal doses for TAN workers during the period from the onset of TAN operations in 1955 through 1970.

NOTE: The only exception to the above conclusion is potential uranium exposures that might have occurred without mixed fission products being present. Those potential exposures might have occurred during 1961–1970, and are being reserved for further evaluation.

- Misc. Reactor Areas: NIOSH concludes that the available bioassay data are such that internal radiation doses received from intakes of mixed fission and activation products, and other applicable radionuclides, can be completely reconstructed with sufficient accuracy for the Miscellaneous Reactor Areas at INL from 1955 through 1970.

NOTE: The year 1968 is being reserved to further investigate Pa-233 separations at the ARA-I hot cells.

- Central Facilities Area: NIOSH concludes that the available bioassay data are such that internal radiation doses received from intakes of mixed fission and activation products, and other applicable radionuclides, can be completely reconstructed with sufficient accuracy for the Central Facilities Area at INL from 1949 through 1970.
- Burial Ground: NIOSH concludes that the available bioassay data are such that internal radiation doses received from intakes of mixed fission and activation products, and other applicable radionuclides, can be completely reconstructed with sufficient accuracy for the Burial Ground from 1953 through 1968.

NOTE: The years 1969 forward are being reserved to further investigate drum-retrieval activities.

Although NIOSH found that it is not possible to completely reconstruct internal radiation doses for workers in the Chemical Processing Plant at the Idaho National Laboratory for the period from January 1, 1963 through December 31, 1974, NIOSH intends to use any internal monitoring data that may become available for an individual claim (and that can be interpreted using existing NIOSH dose reconstruction processes or procedures). Dose reconstructions for individuals working in the CPP during the period from January 1, 1963 through December 31, 1974, but who do not qualify for inclusion in the SEC, may be performed using these data, as appropriate.

7.3 Evaluation of Bounding External Radiation Doses at INL

The principal source of external radiation doses for INL workers was a combination of direct exposures from nuclear reactors and exposures to the various radionuclide source terms at the site, which were predominately attributed to exposures to mixed fission products, activation products, and uranium. See Section 5.0 for a more detailed discussion of the radionuclides that are known to have been present.

The following subsections address the ability to bound external doses, methods for bounding doses, and the feasibility of external dose reconstruction.

7.3.1 Evaluation of Bounding Process-Related External Doses

The following subsections summarize the extent and limitations of information available for reconstructing the process-related external doses of members of the class under evaluation.

7.3.1.1 Electron and Photon Dosimetry Data

Because all workers in the INL's radiological areas were monitored for exposures to electron and photon radiation, and because the DOE provides workers' dosimeter data to NIOSH for dose reconstructions, the external electron and photon doses for the monitored workers can be reconstructed using the guidance in ORAUT-TKBS-0007-6. Because the control dosimeters at INL were likely exposed to elevated levels of onsite ambient (environmental) external radiation due to being located at the entrances of the major operating areas, onsite ambient external doses also need to be assigned to all monitored INL workers to account for any radiation dose that may have been inappropriately subtracted from their dosimeter results as background radiation (ORAUT-TKBS-0007-6).

For unmonitored workers, onsite ambient (environmental) external doses may be assigned. The onsite ambient external doses are limited to photon doses because the unmonitored workers would not have been close enough to the radioactive source terms to receive an external electron dose.

7.3.1.2 Neutron Dosimetry Data

The majority of the INL workers were not monitored for neutron dose. However, the available information indicates that neutron doses were unlikely at INL and that neutron radiation fields are specific to a few facilities (ORAUT-TKBS-0007-6). During the period of evaluation, ORAUT-TKBS-0007-6 indicates that the only location where neutron exposures were possible were at the MTR, TRA Hot Cell Cave, CFA calibration facilities (CF-633 and CF-636), and near some of the transuranics at the Burial Ground (ORAUT-TKBS-0007-6). Recently-captured information, such as the references for Section 5.0, indicates that neutron calibration/check sources (e.g., Ra-Be, Po-Be, Pu-Be, Am-Be, Cf-252) were present at most of the major operating areas at one time or another. Therefore, anyone working near those sources while they were unshielded would have also been exposed to neutron radiation.

Informal observations\reviews of the INL's neutron dosimetry data, conducted while performing dose reconstructions and while capturing records at the INL site, indicate that the neutron doses for the monitored workers are typically less than the dosimeters' limits of detection. In the INL claims, career neutron doses of 500 mrem or greater are rare. The available information also indicates that the INL investigated neutron exposures to unmonitored workers and estimated doses for those workers. As an example, neutron dose was estimated for an MTR worker after a neutron beam was discovered in the area where he was working (Sommers, 1957). Given that the INL likely monitored the workers with the highest potential to receive neutron doses, and given that the monitored workers' neutron doses were typically less than the dosimeters' limits of detection, it is unlikely that an unmonitored INL worker received more than an incidental exposure to neutron radiation. Because unmonitored neutron doses were unlikely at the INL, and because DOE provides the workers' dosimeter data to NIOSH for dose reconstructions, neutron doses for the workers can be reconstructed using the guidance in ORAUT-TKBS-0007-6.

7.3.2 Evaluation of Bounding Ambient Environmental External Doses

Table 4-13 of ORAUT-TKBS-0007-4 provides the onsite ambient (environmental) external doses from 1952 through the end of the evaluation period. For the years 1949–1951, the onsite ambient doses can be bounded by assigning the onsite ambient doses being assigned for the years 1952–1972 because radiological operations prior to 1952 were minimal compared to 1952 and later (ORAUT-TKBS-0007-2).

Because all workers in the INL's radiological areas were monitored for external dose, and because DOE provides workers' dosimeter data to NIOSH for dose reconstructions, the only doses that need to be assigned for unmonitored workers at INL are onsite ambient external doses. Because the control dosimeters at INL were likely exposed to elevated levels of onsite ambient radiation due to being located at the entrances of the major operating areas, onsite ambient doses are also assigned to all monitored INL workers to account for any radiation dose that may have been inappropriately subtracted from their dosimeter results as background radiation (ORAUT-TKBS-0007-6). To bound any onsite ambient dose when an energy employee's work location for a given year is unknown (which is often the case for unmonitored workers), the highest onsite ambient dose for any operating area can be assigned for that year.

7.3.3 Evaluation of Bounding Occupational Medical Doses

NIOSH has sufficient information through documents in the SRDB and ORAUT-TKBS-0007-3 to support the ability to bound the occupational medical doses for the evaluated class.

7.3.4 Methods for Bounding External Dose at INL

There is an established protocol for assessing external exposure when performing dose reconstructions (these protocol steps are discussed in the following subsections):

- Electron and Photon Doses
- Neutron Dose
- Ambient Environmental External Dose
- Occupational Medical Dose

7.3.4.1 Methods for Bounding Operational Period External Dose

Electron and Photon Doses

NIOSH has determined that external electron and photon doses can be reconstructed.

The primary method is the use of individual's external dosimetry records that are provided by DOE. Dosimeter exchange frequencies and thresholds are known and documented. Missed dose may be applied using that information. The necessary biases/corrections that need to be made to the worker's electron and photon dosimetry results are provided in ORAUT-TKBS-0007-6. To account for unmonitored radiation exposures, onsite ambient external doses can be assigned in accordance with the guidance in ORAUT-TKBS-0007-4 and ORAUT-PROC-0060.

Neutron Dose

NIOSH has determined that external neutron doses can be reconstructed.

The primary method is the use of individual's external dosimetry records that are provided by DOE. Dosimeter exchange frequencies and thresholds are known and documented. Missed neutron dose may be applied using that information. The necessary biases/corrections that need to be made to the worker's neutron dosimetry results are provided in ORAUT-TKBS-0007-6. Because unmonitored neutron doses were unlikely at INL, unmonitored neutron doses do not need to be assigned.

Occupational Medical Dose

NIOSH has determined that occupational medical doses can be reconstructed.

NIOSH has sufficient information through documents in the SRDB and ORAUT-TKBS-0007-3 to support the ability to bound the occupational medical doses for the evaluated class.

7.3.4.2 Methods for Bounding Ambient Environmental External Doses

NIOSH has determined that ambient environmental external doses can be reconstructed. The ambient environmental external doses can be reconstructed using the guidance in ORAUT-TKBS-0007-4 and ORAUT-PROC-0060.

7.3.5 External Dose Reconstruction Feasibility Conclusion

NIOSH has reached the following conclusions regarding the feasibility of external dose reconstruction:

- External dose for external electron and photon exposures may be reconstructed for all members of the evaluated INL class during the period under evaluation.
- External dose for neutron exposures may be reconstructed for all applicable members of the evaluated INL class during the period under evaluation.
- Occupational medical dose for occupational X-ray exposures may be reconstructed for all members of the evaluated INL class for the period under evaluation.

7.4 Evaluation of Petition Basis for SEC-00219

The following assertion was made on behalf of petition SEC-00219 for the Idaho National Laboratory:

SEC-00219: *There was no internal monitoring for plutonium, neptunium, or fission products at INL between 1949 and 1970.*

NIOSH has determined that internal monitoring of personnel has focused on fission products since the beginning of radiological operations at the Idaho National Laboratory. *In-vitro* bioassay began in 1953 with 455 gross beta and gross beta/gamma analyses and a single uranium analysis. In 1961, whole-body counting marked the beginning of *in-vivo* bioassay for gamma-emitting radionuclides that are common in fission products. *In-vitro* and *in-vivo* measurements by year are located in Section 6.1 of this evaluation report. During the course of this evaluation, it was determined that internal monitoring for plutonium and neptunium, while limited, was adequately performed. However, beginning in 1963, increased alpha contamination levels at the Chemical Processing Plant were routinely detected with no subsequent increase in plutonium bioassay. Due to inadequate bioassay, NIOSH is recommending the period from January 1, 1963 through December 31, 1974 at CPP for inclusion in the SEC. Significant programmatic improvements were identified and initiated in 1974. Based on a need to further evaluate the implementation of these improvements, NIOSH has reserved the time period beginning January 1, 1975 for further evaluation (ICPP HP Upgrade, 1971-1980). With the exception of this proposed class period, and the locations and periods reserved for further evaluation, NIOSH finds there are sufficient data and information relating to internal exposures and monitoring for the period between 1949 and 1970 at INL.

7.5 Other Potential SEC Issues Relevant to the Petition Identified During the Evaluation

During the feasibility evaluation for SEC-00219, a number of issues were identified that needed further analysis and resolution. The issues and their current status are:

- **ISSUE 1:** SEC-00172 Petitioner-Proposed SEC Petition Class: All employees who worked in all facilities and areas that have been or are operated by the DOE at Idaho National Laboratory, Scoville, Idaho, from January 1, 1950 through December 31, 2005.

RESPONSE: NIOSH completed the SEC-00172 PDR-Professional Judgment with the following finding: Based on the information provided by the petitioner and documentation available, NIOSH finds that there is no support for the petition bases. The petition does not demonstrate:

1. There exists one or more unmonitored, unrecorded, or inadequately monitored or recorded exposure incidents;
2. Exposures and radiation doses potentially incurred by members of the proposed class were not monitored, either through personal monitoring or through area monitoring;
3. Radiation monitoring records were lost, falsified, or destroyed; or that there is no information regarding monitoring, source, source term, or process from the site where the employees worked.

As part of the assessment for this SEC-00219 INL SEC evaluation, NIOSH has reviewed the information and findings of the SEC-00172 petition review and PDR-Professional Judgment and incorporated the applicable information into this evaluation report.

- **ISSUE 2:** Previous petitions evaluated for INL – from Completed ER Matrix

RESPONSE: SEC-00172 is the only previous petition for INL. As part of the assessment for this INL SEC evaluation, NIOSH has reviewed the information and findings of the SEC-00172 petition review and PDR-Professional Judgment and incorporated the applicable information into this evaluation report.

- **ISSUE 3:** The SEC-00219 Petitioner requests that the evaluated class include all employees who worked in any location at the Idaho National Laboratory from January 1, 1949 to December 31, 1970.

RESPONSE: The SEC-00219 Evaluation Report evaluated all employees who worked at the Idaho National Laboratory from January 1, 1949 to December 31, 1970. Argonne National Laboratory-West, located on the INL reservation, will be evaluated as a separate site, per the requirements of the EEOICPA SEC evaluation process, under its own SEC petition number (SEC-00224).

- ISSUE 4: Recent concerns have been raised by the ABRWH about potential actinide exposures at the INL-Radioactive Waste Management Complex.

RESPONSE: The ABRWH concerns about potential actinide exposures at the Radioactive Waste Management Complex pertain to waste retrieval. In 1969, the first exhumation and retrieval project took place at the Burial Ground (also referred to as the Subsurface Disposal Area of the Radioactive Waste Management Complex). At the time of this SEC evaluation, sufficient information relating to the post-1968 waste retrieval in the Burial Ground is not available to support a feasibility conclusion in this report. Accordingly, the post-1968 period at the Burial Ground has been reserved for additional evaluation, which will be included as an Addendum to this evaluation report, or as a separate 83.14 SEC evaluation if the research leads to the conclusion that the current proposed INL SEC class should be extended.

- ISSUE 5: CPP: Assess the ability to reconstruct dose for the portion of the class from 1963-1974 (recommending a SEC class for CPP from 1/63-12/74)

RESPONSE: NIOSH has assessed the CPP exposure sources and associated dose reconstruction methods in this report. Increased potential for intake due to poor contamination control and inadequate personnel monitoring for exposures to transuranics separated from mixed fission products makes it unlikely that exposures to alpha emitters can adequately be reconstructed from January 1963 through December 1974. An SEC class is recommended for CPP from January 1, 1963 to December 31, 1974 due to degradation in radiological conditions resulting in increased alpha contamination without adequate bioassay.

- ISSUE 6: CPP: Assess the ability to reconstruct dose for the portion of the class beyond 1974.

RESPONSE: At the time of this SEC evaluation, the end date for proposed SEC class at CPP has been defined as 1974. Accordingly, the post-1974 period at CPP has been reserved for additional evaluation, which will be included as an Addendum to this evaluation report or as a separate 83.14 SEC evaluation if the research leads to the conclusion that the current proposed INL SEC class should be extended.

- ISSUE 7: Need for a mixed-fission-products co-worker model beginning in 1967 due to a change in the *in-vivo* counting protocol.

RESPONSE: In 1967 INL transitioned towards more reliance on *in-vivo* radiobioassay resulting in fewer *in-vitro* radiobioassay analyses. At that time INL also began a representative *in-vivo* counting program such that workers were only counted every four years. The ability to bound doses requires an *in-vitro* coworker model.

- ISSUE 8: V&V of bioassay data.

RESPONSE: It is firmly believed that the *in-vivo* and *in-vitro* bioassay datasets for INL are complete. However, a verification and validation has not been finished at this time and will be performed as part of the development of a future internal co-worker study for INL.

- ISSUE 9: Use dosimeter information to place workers in particular areas.

RESPONSE: NIOSH has determined that because all of the workers in INL's radiological areas were monitored for external exposures, and the records exist for those workers, this information coupled with the internal monitoring records can be used to place workers in particular radiological work areas at INL. This further supports the ability to separate the CPP as an individual class at INL for the purposes of this SEC evaluation. In addition, a bioassay co-worker model will be developed due to a change in *in-vivo* and *in-vitro* bioassay practices in 1967. NIOSH believes that a bioassay co-worker model stratified by area can be developed based on personnel location information from dosimeter records.

- ISSUE 10: Reserve TAN-615 Actuator Building 1961-1970

RESPONSE: At the time of this SEC evaluation, sufficient information relating to TAN-615, Actuator Building, from 1961-1970 is not available to support a feasibility conclusion in this report. Accordingly, the 1961-1970 period at TAN-615 has been reserved for additional evaluation, which will be included as an Addendum to this evaluation report or as a separate 83.14 SEC evaluation if the research leads to the conclusion that the current proposed INL SEC class should be extended.

- ISSUE 11: Reserve ARA-I in 1968 due to Pa-233 separation.

RESPONSE: At the time of this SEC evaluation, sufficient information relating to Pa-233 exposures at ARA-1 in 1968 is not available to support a feasibility conclusion in this report. Accordingly, the 1968 period at ARA-1 has been reserved for additional evaluation, which will be included as an Addendum to this evaluation report, or as a separate 83.14 SEC evaluation if the research leads to the conclusion that the current proposed INL SEC class should be extended.

- ISSUE 12: OMRE

RESPONSE: During research for the SEC-00219 evaluation report, it was discovered that the Organic Moderated Reactor Experiment (OMRE) at INL was under the direction of the AEC Chicago Operations Office and not the AEC Idaho Operations Office. OMRE was not part of Argonne National Laboratory-West, nor is it a separate covered facility. NIOSH does not believe that this impacts the evaluation decisions presented in this report; a subsequent review of this analysis will be presented separately.

- ISSUE 13: In the evaluation of the 1963 TRA plutonium contamination incident, documentation was found that indicated a link between the plutonium material and CPP (Sommers, 1963). A chemist from CPP filled 13 capsules with rare-earth oxides, fission monitors, and transuranic oxides by weight in the CPP X-Cell Laboratory. Because the samples were isotopically pure, an investigation was performed by NIOSH to determine whether isotopic separations were performed at CPP.

RESPONSE: The materials involved in the 1963 TRA contamination incident were measured into capsules within the CPP X-Cell, but were not separated at this facility. Documentation indicates that the materials were ordered from ORNL and delivered with their specified isotopic purities (Shank, 1964). With this knowledge, NIOSH considers this issue resolved.

- ISSUE 14: The Umpire Laboratory Program began in 1968 with the aim of qualifying U.S. and foreign laboratories to analyze uranium and plutonium materials for the AEC. The program used samples prepared from very pure, well-characterized source materials. As announced by the AEC on May 5, 1965, in Press Release IN-584, the Atomic Energy Division of Phillips Petroleum Company was selected to conduct the program (Tingey, 1968). Because the program involved the preparation and analysis of plutonium samples, NIOSH began an investigation into what role INL had in preparing the plutonium standards.

RESPONSE: Standardizations of the plutonium nitrate, plutonium oxides, and plutonium metal standards were completed by Atlantic Richfield Hanford Company, Los Alamos, New Brunswick Lab, and Rocky Flats Plant. Test samples of these materials were distributed to five U. S. and five foreign laboratories. INL neither prepared nor analyzed the plutonium samples (Shank, 1969). NIOSH considers this issue closed.

7.6 Summary of Feasibility Findings for Petition SEC-00219

This report evaluates the feasibility for completing dose reconstructions for employees at the Idaho National Laboratory from January 1, 1949 through December 31, 1970. NIOSH found that the available monitoring records, process descriptions and source term data available are not sufficient to complete dose reconstructions for the evaluated class of employees.

Table 7-17 summarizes the results of the feasibility findings at Idaho National Laboratory for each exposure source during the time period January 1, 1963 through December 31, 1974 (Chemical Processing Plant) and from January 1, 1949 through December 31, 1970 (remainder of INL site, including CPP from 1953-1962, and excluding the reserved portions of the site).

Table 7-17: Summary of Feasibility Findings for SEC-00219				
January 1, 1963 through December 31, 1974 (Chemical Processing Plant); January 1, 1949 through December 31, 1970 (INL site excluding CPP SEC class and reserved areas)				
Source of Exposure	Chemical Processing Plant Jan. 1, 1963 through Dec. 31, 1974		INL Site Excluding CPP SEC Class and Reserved Areas Jan. 1, 1949 through Dec. 31, 1970	
	Reconstruction Feasible	Reconstruction Not Feasible	Reconstruction Feasible	Reconstruction Not Feasible
Internal¹		X²	X	
- U		X	X	
- Np		X	X	
- Pu		X	X	
- Th		X	X	
- Other transuranic radionuclides		X	X	
- Fission products	X		X	
- Noble gases	X		X	
- Iodine	X		X	
- Tritium	X		X	
External	X³		X	
- Gamma	X		X	
- Beta	X		X	
- Neutron	X		X	
- Occupational Medical X-ray	X		X	

¹ Internal evaluation of bioassay data included urinalysis/fecal (*in-vitro*) data and lung/whole body count (*in-vivo*) data

PARTIAL DOSE RECONSTRUCTION INFORMATION:

² INTERNAL: For the purpose of partial dose reconstruction for members of the proposed SEC class who worked at CPP from 1963 through 1974, partial DRs could include dose from any radionuclides for which specific personal monitoring data exist that can be assessed by methods defined in approved NIOSH dose reconstruction procedures or processes, but may not include dose from U, Np, Pu, or Th (or other alpha-emitters) that have been separated from fission products, based on ratios of these with fission products.

³ EXTERNAL: For the purpose of partial dose reconstruction for members of the proposed SEC class who worked at CPP from 1963 through 1974, partial DRs should include external dose based on the specific personal monitoring data that exist, or external DR methods as defined in approved NIOSH dose reconstruction procedures or processes.

As of February 2, 2015, a total of 1074 claims have been submitted to NIOSH for individuals who worked at INL during the period under evaluation in this report. Dose reconstructions have been completed for 956 individuals (~98%).

Although NIOSH found that it is not possible to completely reconstruct radiation doses for the proposed class, NIOSH intends to use any internal and external monitoring data that may become available for an individual claim (and that can be interpreted using existing NIOSH dose reconstruction processes or procedures). Therefore, dose reconstructions for individuals employed in the Chemical Processing Plant at the Idaho National Laboratory during the period from January 1, 1963 through December 31, 1974, but who do not qualify for inclusion in the SEC, may be performed using these data as appropriate.

Table 7-18 provides a more general summary of the six individual feasibility tables provided in Section 7.2, *Evaluation of Bounding Internal Radiation Doses at INL* (i.e., Sections 7.2.1 through 7.2.6 for each of the six operating areas under evaluation). Whereas the individual feasibility tables are more specific as to exposure sources, Table 7-18 provides the most restrictive feasibility designation for each year for that operating area.

The reserved portions of the site are:

- TAN: TAN-607 (Fuel Storage Vaults) and TAN-615 (Actuator Building) from 1961-1970 due to potential uranium exposures without mixed fission products being present
- Misc. Reactor Areas: ARA-I in 1968 due to potential unmonitored exposure to Pa-233
- Burial Ground: The years 1969 forward due to a newly-implemented procedure of waste exhumation and retrieval

Table 7-18: Summary of INL Feasibility Determinations by Operating Area (1949-1974)

INL Operating Area	Years																									
	49	50	51	52	53	54	55	56	57	58	59	60	61	62	63	64	65	66	67	68	69	70	71	72	73	74
Test Reactor Area	N	N	N	F	F	F	F	F	F	F	F	F	F	F	F	F	F	F	C	C	C	C	N	N	N	N
Chemical Processing Plant	N	N	N	N	F	F	F	F	F	F	F	F	F	F	I	I	I	I	I	I	I	I	I	I	I	I
Test Area North	N	N	N	N	N	N	F	F	F	F	F	F	R	R	R	R	R	R	R	R	R	R	N	N	N	N
Misc. Reactor Areas	N	N	N	N	N	N	F	F	F	F	F	F	F	F	F	F	F	F	C	R	C	C	N	N	N	N
Central Facilities Area	F	F	F	F	F	F	F	F	F	F	F	F	F	F	F	F	F	F	C	C	C	C	N	N	N	N
Burial Ground	N	N	N	F	F	F	F	F	F	F	F	F	F	F	F	F	F	F	C	C	R	R	N	N	N	N

F = Dose reconstructions are feasible.

C = Dose reconstructions are feasible but a mixed-fission-product co-worker model is needed.

I = Dose reconstructions are infeasible.

R = Reserved for further evaluation.

N = Prior to radiological operations or outside of evaluation period

8.0 Evaluation of Health Endangerment for Petition SEC-00219

The health endangerment determination for the class of employees covered by this evaluation report is governed by both EEOICPA and 42 C.F.R. § 83.13(c)(3). Under these requirements, if it is not feasible to estimate with sufficient accuracy radiation doses for members of the class, NIOSH must also determine that there is a reasonable likelihood that such radiation doses may have endangered the health of members of the class. Section 83.13 requires NIOSH to assume that any duration of unprotected exposure may have endangered the health of members of a class when it has been established that the class may have been exposed to radiation during a discrete incident likely to have involved levels of exposure similarly high to those occurring during nuclear criticality incidents. If the occurrence of such an exceptionally high-level exposure has not been established, then NIOSH is required to specify that health was endangered for those workers who were employed for a number of work days aggregating at least 250 work days within the parameters established for the class or in combination with work days within the parameters established for one or more other classes of employees in the SEC.

NIOSH has determined that the increased potential for intake due to poor contamination control and inadequate personnel monitoring for exposures to transuranics separated from mixed fission products makes it unlikely that exposures to alpha emitters can adequately be reconstructed from January 1963 through December 1974. The *Preliminary ICPP Health Physics Upgrade Program* report was published and delivered to CPP management in October 1974. The class end date was changed to December 31, 1974 as a convenience since further NIOSH-ORAUT review and assessment will be necessary to determine if the program data from 1975 forward is adequate to support reconstructing dose with sufficient accuracy for this area.

NIOSH did not identify any evidence supplied by the petitioners or from other resources that would establish that members of the proposed SEC class at the Idaho Chemical Processing Plant (CPP) between January 1, 1963 and December 31, 1974 were exposed to radiation during a discrete incident resulting in significant unmonitored exposures likely to have involved exceptionally high-level exposures. However, evidence indicates that some workers in the proposed class may have accumulated substantial chronic exposures through episodic intakes of radionuclides, combined with external exposures to gamma, beta, and neutron radiation. Based on its assessment, presented in this evaluation report, NIOSH finds that there were issues that make it unlikely that exposures to alpha-emitters can be adequately reconstructed from January 1, 1963 through December 31, 1974. Consequently, NIOSH has determined that health was endangered for those CPP workers from January 1, 1963 through December 31, 1974 who were employed for at least 250 aggregated work days either solely under their employment or in combination with work days within the parameters established for other SEC classes.

For the workers at the INL site for the period of January 1, 1949 through December 31, 1970 (excluding the CPP workers from January 1, 1963 through December 31, 1974, and those workers in the areas with reserved periods in this report), a health endangerment determination is not required because NIOSH has determined that it has sufficient information to estimate dose for the members of the evaluated class.

9.0 Class Conclusion for Petition SEC-00219

Based on its full research of the class under evaluation, NIOSH has defined a single class of employees for which NIOSH cannot estimate radiation doses with sufficient accuracy. The NIOSH-proposed class to be added to the SEC includes all employees of the Department of Energy, its predecessor agencies, and their contractors and subcontractors who worked at the Idaho National Laboratory in Scoville, Idaho, and were monitored for external radiation at the Idaho Chemical Processing Plant (CPP) (e.g., at least one film badge or TLD dosimeter from CPP) between January 1, 1963 and December 31, 1974 for a number of work days aggregating at least 250 work days, occurring either solely under this employment, or in combination with work days within the parameters established for one or more other classes of employees in the Special Exposure Cohort. For all non-CPP workers on the remainder of the INL site, there are sufficient monitoring data to make dose reconstruction feasible for the time period from January 1, 1949 through December 31, 1970.

NIOSH has carefully reviewed all material sent in by the petitioner, including the specific assertions stated in the petition, and has responded herein (see Section 7.4). NIOSH has also reviewed available technical resources and many other references, including the Site Research Database (SRDB), for information relevant to SEC-00219. In addition, NIOSH reviewed its NOCTS dose reconstruction database to identify EEOICPA-related dose reconstructions that might provide information relevant to the petition evaluation.

These actions are based on existing, approved NIOSH processes used in dose reconstruction for claims under EEOICPA. NIOSH's guiding principle in conducting these dose reconstructions is to ensure that the assumptions used are fair, consistent, and well-grounded in the best available science. Simultaneously, uncertainties in the science and data must be handled to the advantage, rather than to the detriment, of the petitioners. When adequate personal dose monitoring information is not available, or is very limited, NIOSH may use the highest reasonably possible radiation dose, based on reliable science, documented experience, and relevant data to determine the feasibility of reconstructing the dose of an SEC petition class. NIOSH contends that it has complied with these standards of performance in determining the feasibility or infeasibility of reconstructing dose for the class under evaluation.

10.0 References

42 C.F.R. pt. 81, *Guidelines for Determining the Probability of Causation Under the Energy Employees Occupational Illness Compensation Program Act of 2000*; Final Rule, Federal Register/Vol. 67, No. 85/Thursday, p. 22,296; May 2, 2002; SRDB Ref ID: 19391

42 C.F.R. pt. 82, *Methods for Radiation Dose Reconstruction Under the Energy Employees Occupational Illness Compensation Program Act of 2000*; Final Rule; May 2, 2002; SRDB Ref ID: 19392

42 C.F.R. pt. 83, *Procedures for Designating Classes of Employees as Members of the Special Exposure Cohort Under the Energy Employees Occupational Illness Compensation Program Act of 2000*; Final Rule; May 28, 2004; SRDB Ref ID: 22001

42 U.S.C. §§ 7384-7385 [EEOICPA], *Energy Employees Occupational Illness Compensation Program Act of 2000*, as amended

AEC, 1954-1960, *Various INEL Area Maps*; U.S. Atomic Energy Commission (AEC) Idaho Operations Office; various dates ranging from 1954 to 1960; SRDB Ref ID: 117427

AEC, 1954-1986, *National Reactor Testing Station Plot Plans for Various Areas*; U.S. Atomic Energy Commission (AEC) Idaho Operations Office; various dates ranging from 1954 to 1986; SRDB Ref ID: 86891

AEC, Jan-Dec1967, *Major Activities in the Atomic Energy Programs, January-December 1967*, INDC-216; U.S. Atomic Energy Commission; January 1968; SRDB Ref ID: 115844

AEC, Apr1967, *Quarterly Technical Report STEP Project for July 1966 – September 1966*, IDO-17213; U.S. Atomic Energy Commission (AEC); April 1967; SRDB Ref ID: 140006

AEC, 1970, *Nuclear Technology Branch Annual Progress Report for Period Ending June 30, 1969*, IN-1317; Atomic Energy Commission (AEC); Issued January 1970; SRDB Ref ID: 136165

AEC Annual Report, 1960, *Annual Report to Congress of the Atomic Energy Commission for 1960*, U.S. Atomic Energy Commission; January 1961; SRDB Ref ID: 40909

Affidavit, 2014, Affidavit from Petitioner supporting Petition SEC-00219 for Idaho National Laboratory, received August 29, 2014; DSA Ref ID: 120226

Air Monitoring, Feb1953-Oct1954, *Alpha Activity Results for Constant Air Monitors (February 1953-October 1954)*; dates ranging from February 1953-October 1954; SRDB Ref ID: 138649

Air Monitoring, Dec1956-Aug1957, *Long Life Activity of Constant Air Monitors and ¼ of Filters and Beta and Alpha Activity Results for Constant Air Monitors (December 1956-August 1957)*; dates ranging from December 1956-August 1957; SRDB Ref ID: 138651

Air Monitoring, 1965-1966, *Air Samples, Calculations, and Plots (1965-1966)*; dates ranging from 1965-1966; SRDB Ref ID: 138630

Air Monitoring, Mar1965-Dec1966, *MTR Air Monitoring Surveys and Isotopic Analysis (March 1965-December 1966)*; dates ranging from March 1965-December 1966; SRDB Ref ID: 140302

Air Monitoring, 1966, *MTR Stack, Particulate Spectrums, Isotopic Analysis and Air Monitoring (1966)*; various dates throughout 1966; SRDB Ref ID: 140286

Air Monitoring, 1966-1967, *ETR High Volume Air Sample Spectra (1966-1967)*; dates ranging from 1966-1967; SRDB Ref ID: 140177

Alpha Surveys, 1962-1968, *Test Area North Alpha Surveys*; author unknown; 1962-1968; SRDB Ref ID: 140265

Analytical Lab, 1957, *Analytical Control Laboratory Operating Manual*, IDO-14396; M. J. Painter; Phillips Petroleum Co.; March 21, 1957; SRDB Ref ID: 139890

Analytical Program, 1957, *Analytical Program for Processing Aluminum-Uranium Reactor Fuel Elements*, IDO-14412, R. C. Shank; Phillips Petroleum Co.; August 15, 1957; SRDB Ref ID: 140043

Anderson, 1974, *Personnel Dosimetry and Exposure Control at the ICPP*; D. K. Jenson; 1974; SRDB Ref ID: 118886, PDF p. 8

Becar, 1961, *Critical Experiment Tank (CET) Reactor Hazards Summary*, XDC-61-4-709; N. J. Becar, J. F. Kunze, G. D. Pincock, and L. D. VanVleck; March 31, 1961; SRDB Ref ID: 1093

Belnap, 1963, *Waste Disposal Report and Authorization Form for CFA Laundry*; October 1963; Vern E. Belnap; SRDB Ref ID: 139214

Bengstad, 1962, *Radioactive Shipment Record*; R. H. Bengstad; October 16, 1962; SRDB Ref ID: 138788, PDF p. 17

Bentzen, 1963, *Safety Analysis Report – SNAPTRAN 2/10A-1 Safety Tests*, IDO-16825; F. L. Bentzen et al.; January 28, 1963; SRDB Ref ID: 136849

Bioassay, 1956-1984, *INEL Bioassay CD 1 of 3*; author unknown; 1956-1984; SRDB Ref ID: 123095

Bioassay, 1956-1967, *INEL Bioassay CD 2 of 3*; author unknown; 1956-1957; SRDB Ref ID: 123096

Bioassay, 1958-1986, *INEL Bioassay CD 3 of 3*; author unknown; 1958-1986; SRDB Ref ID: 123104

Bjorklund, 1970, *Revised Safety Analysis Report for the ICPP Denitration Process*; W. J. Bjorklund and G. F. Offutt; December 11, 1970; SRDB Ref ID: 116061

Boone, 1959, *Gross Activity Stack Monitoring Results and Environmental Hazards Evaluation for the D101-L2A and D101-L2C Test Series*, DC-59-7-722; F. W. Boone; July 30, 1959; SRDB Ref ID: 31951

Brugger, 1975, *Nuclear Technology Division Annual Progress Report for Period Ending June 30, 1974*, ANCR-1177; R. M. Brugger; January 1975; SRDB Ref ID: 140199, PDF p. 24

Burial Ground, 1962, *NRTS Burial Ground Standard Practices Manual*; 5.61.2; author unknown; SRDB Ref ID 140874, PDF p. 3

CAM, 1961, *CAM Filter Counts for Long-Lived Alpha and Beta 1961*; author unknown; 1961; SRDB Ref ID: 140193

CAM, 1962-1963, *Test Area North Logbook of CAM Filter Results 1962-1963*; Author unknown; 1962-1963; SRDB Ref ID: 140255

CAM, 1963-1964, *Test Area North Logbook of CAM Filter Results 1963-1964*; author unknown; 1963-1964; SRDB Ref ID: 140257

CAM, 1964-1967; *Test Area North Logbook of CAM Filter Results 1964-1967*; author unknown; 1964-1967; SRDB Ref ID: 140259

CAM 1967-1970, *CAM Filter Counts from May 8, 1967 to March 12, 1970*; unknown author; various dates; SRDB Ref ID: 138064

CFA HP Logs, 1965-1966, *CFA Health Physics Log Sheets January 1965 – December 1966*; SRDB Ref ID: 139293

Chemical Programs, 1972, *Idaho Chemical Programs Annual Technical Report: Fiscal Year 1971*, ICP-1006, J. A. Buckham; Allied Chemical Corporation; May 1972; SRDB Ref ID: 83365

Cipperley, 1958, *Personnel Metering Operating Techniques, Self-Service System, Effective August 20, 1951 through March 29, 1958*, F. V. Cipperley; IDO-12007; U.S. Atomic Energy Commission, Idaho Operations Office; 1958; SRDB Ref ID: 8112

Cipperley, 1968, *Personnel Dosimetry Standard Operating Procedure Effective March 30, 1958*, F. V. Cipperley; IDO-12070; U.S. Atomic Energy Commission, Idaho Operations Office; December 1968; SRDB Ref ID: 8086

Condotta, 1981, *Action Plans – Shift Laboratory*; DC-3-81; D. L. Condotta; July 14, 1981; SRDB Ref ID: 124536, PDF p. 10

Condotta, 1981a, *Action Plans – Shift Laboratory*; DC-3-81; D. L. Condotta; July 14, 1981; SRDB Ref ID: 124536, PDF p. 15

Conner, 1956, *MTR Technical Branch Quarterly Report, First Quarter – 1956*; W. P. Conner; June 8, 1956; SRDB Ref ID: 139938

Cordes, 1963, *TAN Health Physics Progress Reports for 1963*, O. L. Cordes; various dates throughout 1963; SRDB Ref ID: 138714

Cordes, 1963a, *TAN Health Physics Progress Report for March 1963*, O. L. Cordes; April 23, 1963; SRDB Ref ID: 138714, PDF pp. 45-49

CPP Air, 1957-1960, *CPP Sample Record Sheets Air Samples February 1957 - January 1960*; author unknown; SRDB Ref ID: 140233

CPP Contract, 1955, *Idaho Chemical Processing Plant Contract AT(10-1)-728, Design & Operations Manual for SIR-STR Fuel Processing BKC-4193*; IDO-18002; January 3, 1955; SRDB Ref ID: 83201 ECI

CPP Dosimetry, 1984, *ICPP Internal Dosimetry Procedures Manual*, L. Guinn; Westinghouse Idaho Nuclear Company, Inc.; 1984; SRDB Ref ID: 118948

CPP Fact Sheet, undated, *The Idaho Chemical Processing Plant (ICPP) (A Fact Sheet)*, B. F. Boardman; U. S. Atomic Energy Commission; undated; SRDB Ref ID: 14658

CPP Hi Vol Air, 1960-1961, *CPP High Volume Air Sample Logsheets with Alpha and Beta Measurements 1960-1961*; author unknown; SRDB Ref ID: 140399

CPP HP Manual, 1952, *CPP Health Physics Manual April 1952*; IDO-14055; author unknown; SRDB Ref ID: 8095

CPP HP Surveys, 1970, *CPP HP Routine Surveys December 1970*; author unknown; 1970; SRDB Ref ID: 138084

CPP Krypton, 1979, *Recovery and Purification of Krypton Gas at ICPP*, BUC-153-70; April 29, 1979; SRDB Ref ID: 47090

CPP Phase-out, 1994, *Idaho Chemical Processing Plant and Plutonium-Uranium Extraction Plant Phase-out/Deactivation Study*, WHC-EP-0693, M. W. Patterson; Westinghouse Hanford Company; January 1994; SRDB Ref ID: 88360

CPP Plan, 1997, *Field Sampling Plan for the D&D of the CPP-631 RaLa Building, and CPP-709 and CPP-734 Monitoring Stations at the Idaho Chemical Processing Plant*, R. W. Jones; INEEL/EXT-97-00805; Lockheed Martin; August 1997; SRDB Ref ID: 140747

CPP Progress Report, Feb1954, *Idaho Chemical Processing Plant Progress Report – February, 1955*, F. P. Vance; IDO-14297; April 23, 1954; SRDB Ref ID: 87334 ECI

CPP Progress Report, Sep1955, *Idaho Chemical Processing Plant Progress Report – September, 1955*, F. P. Vance; IDO-14355; October 24, 1955; SRDB Ref ID: 87332 ECI

CPP Progress Report, Nov1957, *Idaho Chemical Processing Plant Progress Report – November, 1957*, F. P. Vance; PTR-262; December 12, 1957; SRDB Ref ID: 87154 ECI

CPP Progress Report, Jan1958, *Idaho Chemical Processing Plant Progress Report – January 1958*, F. P. Vance; PTR-279; February 13, 1958; SRDB Ref ID: 83171 ECI

CPP Progress Report, Feb1958, *Idaho Chemical Processing Plant Progress Report – February 1958*, F. P. Vance; PTR-288; March 14, 1958; SRDB Ref ID: 88004 ECI

CPP Progress Report, Jul1958, *Idaho Chemical Processing Plant Progress Report – July 1958*, F. P. Vance; PTR-333; August 25, 1958; SRDB Ref ID: 83177 ECI

CPP Progress Report, Aug1958, *Idaho Chemical Processing Plant Progress Report – August 1958*, F. P. Vance; PTR-333; October 10, 1958; SRDB Ref ID: 83178 ECI

CPP Progress Report, Sep1958, *Idaho Chemical Processing Plant Progress Report – September 1958*, F. P. Vance; PTR-355; November 10, 1958; SRDB Ref ID: 83179 ECI

CPP Progress Report, Jun1959, *Idaho Chemical Processing Plant Progress Report – June 1959*, F. P. Vance; PTR-427; August 27, 1959; SRDB Ref ID: 83196 ECI

CPP RaLa, 1969, *Control of Fission Product Activity During Short-Cooled Fuel Processing Connected with the ICPP RaLa Process*, J. R. Bower; Idaho National Laboratory; paper presented in Vienna, Austria on May 27-30, 1969; SRDB Ref ID: 32034

CPP Safety Review, 1974, *Idaho Chemical Processing Plant Safety Review Document, Volume I*, ICPP-SRD-1; G. K. Cederberg; Allied Chemical Corporation; March 1974; SRDB Ref ID: 14660

CPP Waste Management, 1960, *Waste Management at the Idaho Chemical Processing Plant*, IDO-14551, A. L. Ayers; Phillips Petroleum Company; December 5, 1960; SRDB Ref ID: 139906

Cusimano, 1963, *Latent Image Fading in Personal Neutron Monitoring Film at the NRTS*, J. P. Cusimano; IDO-12031; U.S. Atomic Energy Commission, Idaho Operations Office; 1963; SRDB Ref ID: 8135

D101 L2A-1, 1959, *Test Results from D101 L2A-1 Power Testing, IET #14, DC 59-8-728*; various authors; August 19, 1959; SRDB Ref ID: 12732

Davis, 1970, *Critical Experiments in an MTR Mockup Using Phoenix Fuel*, BNWL-1481; E. C. Davis, Jr., R. I. Smith, L. D. Williams; June 1970; SRDB Ref ID: 118572

DCAS-PR-004, *Internal Procedures for the Evaluation of Special Exposure Cohort Petitions, Rev. 1*, National Institute for Occupational Safety and Health (NIOSH); Cincinnati, Ohio; April 15, 2011; SRDB Ref ID: 94768

Dierks, 1963, *Contamination in TAN-615 Building*, correspondence to V. V. Hendrix; D. H. Dierks; July 3, 1963; SRDB Ref ID: 141264

DOE, 1991, *Idaho National Engineering Laboratory Historical Dose Evaluation, Volume 2: Appendices*, DOE/ID-12119; U.S. Department of Energy (DOE) Field Office, Idaho; August 1991; SRDB Ref ID: 1109

DOE, 2009, *Engineering Evaluation/Cost Analysis for Decommissioning of the TRA-632 Hot Cells*, DOE/ID-11397; Department of Energy (DOE); September 2009; SRDB Ref ID: 87764

EG&G, 1977, *LOFT Integral Test System Final Safety Analysis Report Revision 1*, Volume 2 of 3; EG&G Idaho, Inc.; August 1977; SRDB Ref ID: 88511

EOCR, 1959, *Experimental Organic Cooled Reactor: Conceptual Design*, J. R. Huffman; Phillips Petroleum Company; December 1, 1959; SRDB Ref ID: 137817

ETR Exposure History, 1993, *Occupational Radiation Exposure History of Idaho Field Office Operations at the INEL*, J. R. Horan and J. B. Braun; EGG-CS-11143; Idaho National Engineering Laboratory; October 1993; SRDB Ref ID: 1023

ETR Surveys, 1961-1962, *ETR Cubicle Radiation Surveys 1961-1962*; author unknown; 1961-1962; SRDB Ref ID: 140463

Fire, 1970, *Burial Ground Fire June 1, 1970*; various authors; 1970; SRDB Ref ID: 139276

Freeman, 1964, *Tan Hot Shop and Satellite Facilities*, IDO-17032; R. A. Freeman; November 1964; SRDB Ref ID: 138791

G&H Air, 1955, *G & H Cell (RAF) Air Samples*; author unknown; 1955; SRDB Ref ID: 140227

GCRE Final Report, 1964, *Army Gas-Cooled Reactor Systems Program Final Report: Full Power and Limited Endurance Test of the ML-1 Nuclear Power Plant*, IDO-28634, R. H. Chesworth; Aerojet-General Nucleonics; September 1964; SRDB Ref ID: 136848

GCRE Progress Report, 1959, *Army Gas-Cooled Reactor Systems Program, Monthly Progress Report*, April 1959, G. A. Linenberger; Aerojet-General Nucleonics; May 25, 1959; SRDB Ref ID: 136834

General Electric, 1953, *Nuclear Power Plant Testing in the IET*, APEX-131; General Electric; May 1953; SRDB Ref ID: 40238

General Electric, 1961, *Test Program and Procedures for STP Program A*, single page; General Electric; July 1961; SRDB Ref ID: 1068

Gesell, 1986, *Minimum Reporting Levels for the Panasonic Dosimetry Systems*, letter to dosimetry customers, T. F. Gesell; Radiological and Environmental Sciences Laboratory; May 15, 1986; SRDB Ref ID: 8123

Gesell, 1992, *Technical Basis of the INEL Personal Photon-Beta Dosimeter*, T. F. Gesell, M. A. Hall, and B. L. Anderson; Idaho State University, Department of Physics, December 1, 1992; SRDB Ref ID: 8163

Gesell, 1996, *Technical Basis of the INEL Personal Neutron Dosimeter*; Report 960112 Attachment #4; T. F. Gesell; January 12, 1996; SRDB Ref ID 8157, PDF p. 19

Ginkel, 1959, *Report of Investigation, Nuclear Incident at the Idaho Chemical Processing Plant*; William L. Ginkel; undated; SRDB Ref ID: 88098

Ginkel, 1960, *Nuclear Incident at the Idaho Chemical Processing Plant on October 16, 1959, Report of the Investigating Committee*; William L. Ginkel; February 15, 1960; SRDB Ref ID: 12784

Grigg, 2008, *Safety Analysis Report for the INTEC Laboratory Facilities (CPP-602 Laboratory and CPP-630 Mass Spectrometry Facility)*, SAR-121; Document owner: Clayne B. Grigg; May 20, 2008; SRDB Ref ID: 116935

H&S Bulletin, 1958, *H&S Instruction Bulletin 3.20: Neutron Sources*; H&S IB-3.20; author unknown; June 10, 1958; SRDB Ref ID: 85432, PDF pp. 137-138

Hawley, 1965, *Alpha Contamination Incident at MTR*; C. A. Hawley; September 14, 1965; SRDB Ref ID: 140170

Hayden, 1959, *CPP Incident – October 16, 1959*; Ha-180-59A; R. E. Hayden; November 3, 1959; SRDB Ref ID: 31947

Hayden, 1959a, *CPP Health Physics Monthly Report, Period July 1 through July 31, 1959*; Ha-135-59A; R. E. Hayden; August 7, 1959; SRDB Ref ID: 87080, PDF p. 21

Hayden, 1959b, *CPP Health Physics Monthly Report, Period August 1 through August 31, 1959*; Ha-159-59A; R. E. Hayden, September 9, 1959; SRDB Ref ID: 87080, PDF p. 14

Hayden, 1961, *HP Accomplishments 1960*; Ha-11-61A-N; R. E. Hayden; February 3, 1961; SRDB Ref ID: 139251

Hayden, 1962, *NRTS Burial Ground Standard Practices Manual*; 5.61.2; R. E. Hayden; April 13, 1962; SRDB Ref ID: 140874

Hazards Control Qtr, 1965, *Hazards Control Quarterly Report No. 22 (July-September 1965)*; UCRL-14534; various authors; undated; SRDB Ref ID: 13888

Hofmann, 1965, *Progress Report – Phoenix Fuel Program – FY-1965*, BNWL-152; P. L. Hofmann; August 15, 1965; SRDB Ref ID: 118622

Hoover, 1961, *SL-1 Health Physics Data Report No. II*, DR-RO-2; R. L. Hoover; February 6, 1961; SRDB Ref ID: 83650

Horan, 1959, *Health and Safety Division Annual Report, 1958*, IDO-12012; John R. Horan and multiple other authors; not dated, but likely written in 1959; SRDB Ref ID: 8079

Horan, 1961, *Health and Safety Division Annual Report, 1960*, IDO-12019; John R. Horan and multiple other authors; September 1961; SRDB Ref ID: 8078

Horan, 1962, *Health and Safety Division Annual Report, 1961*, IDO-12021; John R. Horan and multiple other authors; May 21, 1962; SRDB Ref ID: 8076

Horan, 1963, *Health and Safety Division Annual Progress Report, 1963*; IDO-12037; John R. Horan; August 1964; SRDB Ref ID: 13449, PDF p. 17

Howe, 1986, *Summary of B-331 Radiation Protection Program Results - 1985*; H. J. Howe; March 3, 1986; SRDB Ref ID: 14076

HP Logbook, 1959, *HP Logbook for SPERT August 12, 1958 – October 29, 1959*; author unknown; 1958-1959; SRDB Ref ID: 141077

HP Log Sheets, 1972, *Health Physics Log Sheets for June 1972-November 1972*; SRDB Ref ID: 141076

HP Monthly Reports, 1957, *Health Physics Monthly Progress Reports 1957*; various authors; SRDB Ref ID: 85474

HP Monthly Reports, 1959-1960, *Health Physics Monthly Reports 1959-1960*; J. W. McCaslin; SRDB Ref ID: 138195, PDF pp. 37-38, 86-87, 105-106, 123, 152

HP Monthly Reports, 1962, *Health Physics Monthly Reports - 1962*, Phillips Petroleum; various authors; monthly for 1962; SRDB Ref ID: 138197

HP Regs, 1963, *Health Physics Regulations Related to L Cell and RaLa Processing, Standard Practices Manual*, 6.10.3; author unknown; March 14, 1963; SRDB Ref ID: 138258

Hueter, 1963, *Radioactive Waste Reports, MTR Liquid and Airborne and ETR Liquid, October-November 1963*; L. J. Hueter; 1963; SRDB Ref ID: 138892

Hughes, 2002, *Building 707 Facility Complex Decommissioning Basis for Interim Operation (DBIO) Revision 4*; S. R. Hughes; February 2002; SRDB Ref ID: 104875

I-131 Containment, 1961, *Containment of Iodine-131 Released by the RaLa Process*, IDO-14566, G. K. Cederberg; Phillips Petroleum Company; October 30, 1961; SRDB Ref ID: 133328

ICPP HP Upgrade, 1971-1980, *Preliminary ICPP Health Physics Upgrade Program*; various authors, 1971-1980; SRDB Ref ID: 124516

IDO Report, 1961, *IDO Report on the Nuclear Incident at the SL-1 Reactor*, IDO-19302; author unknown; January 1962; SRDB Ref ID: 87848

Incoming Radioactive Shipment Records, 1961, *Incoming Radioactive Shipments April – December 1961*; author unknown; SRDB Ref ID: 140188

INEEL, 1998, *Historic American Engineering Record – Photographs, Written Historical and Descriptive Data for Various Years*; Idaho National Engineering and Environmental Laboratory (INEEL); Received September 15, 1998; SRDB Ref ID: 139434; SRDB Ref ID: 118550

INEEL, 2004, *Removal Action Work Plan for the Decontamination and Decommissioning of Building CPP-627, the Remote Analytical Facility*, DOE/NE-ID-11158; Idaho National Engineering and Environmental Laboratory (INEEL); June 2004; SRDB Ref ID: 139435

INEEL, 2005, *Historical American Engineering Record—Idaho National Engineering and Environmental Laboratory—Test Area North, HAER No. ID-33-E*, INEEL/EXT-04-02536; Idaho National Engineering and Environmental Laboratory (INEEL); February 2005; SRDB Ref ID: 83751

INEL Bioassay, 2010a, *INEL Bioassay Records, CD 1 of 3*, Idaho National Laboratory; historical records (10,583 pages) collected by NIOSH on September 1, 2010; various dates and years; SRDB Ref ID: 123095

INEL Bioassay, 2010b, *INEL Bioassay Records, CD 2 of 3*, Idaho National Laboratory; historical records (10,583 pages) collected by NIOSH on September 1, 2010; various dates and years; SRDB Ref ID: 123095

INL, 1963, *Brief SNAPTRAN Program Summary*; Idaho National Laboratory (INL); Circa 1963; SRDB Ref ID: 139088

INL, 2006; *Final Report for the Decontamination and Decommissioning of CPP-627 Remote Analytical Facility*, ICP/EXT-06-01145; Idaho National Laboratory (INL); February 2006; SRDB Ref ID: 139433

INL, 2009, *Idaho National Laboratory Cultural Resource Management Plan*, Rev. 3, DOE/ID-10997; Idaho National Laboratory (INL); February 2009; SRDB Ref ID: 119133

Irvine, 1954, *Idaho Chemical Processing Plant Process and Laboratory Building Operating Manual*, Volume 1, IDO-14277; V. W. Irvine; June 1954; SRDB Ref ID: 87771 ECI

Johnson, 1961, *MTR Health Physics Report for July 1961*; Joh-25-61A; Blair D. Johnson; August 18, 1961; SRDB Ref ID: 138196, PDF pp. 12, 180-181

Johnson, 1963, *MTR Health Physics Report for November, 1963*; Joh-3-64A; Blair D. Johnson; January 8, 1964; SRDB Ref ID: 138880, PDF pp. 5-6

Johnson, 1965, *MTR Health Physics Report for December, 1964*, LJJ-2-65A; LaMar J. Johnson; January 14, 1965; SRDB Ref ID: 139193, PDF p. 3

Johnson, 1965a, *TRA Hot Cell Contamination 8-9-65*; LJJ-36-65A; L. J. Johnson; August 10, 1965; SRDB Ref ID: 125970, PDF pp. 84, 116, 122-125, 131, 133

Johnson, 1969, *Pu and Am-241 Levels in Rocky Flats Wastes at INL*; October 13, 1969; Blair Johnson; SRDB Ref ID: 125546

- Johnston, 1952, *Health Physics Services Provided at the NRTS*, ID-B&M; L. E. Johnston; April 14, 1952; SRDB Ref ID: 139103
- Kalbeitzner, 1983, *Reportable Threshold Reading from the Unshielded Dosimeter of the INEL Personnel Badge*, memorandum to Dosimetry Branch, F. L., Kalbeitzner; Radiological and Environmental Sciences Laboratory; Idaho Falls, Idaho; March 25, 1983; SRDB Ref ID: 8154
- Keller, 1958, *Air Activity Incident – MTR Reactor Building, December 15, 1958*, correspondence to R. L. Doan; F. R. Keller; December 16, 1958; SRDB Ref ID: 139186
- Keller, 1958a, *MTR Progress Report Cycles No. 108 and 109, August 4 thru September 8, 1958*, IDO-16496; F. R. Keller; October 1, 1958; SRDB Ref ID: 83102
- Kunze, 1970, *Facility Operating Manual-Low Power Test Facility*, ANCR-1137; J. F. Kunze and P. L. Chase; December 1970; SRDB Ref ID: 1037
- Latchum, 1963, *Findings of Accident Review Committee, Alpha Contamination Incident, Test Reactor Area (TRA) November 15-18, 1963*; J. W. Latchum; December 10, 1963; SRDB Ref ID 88068, PDF pp. 1-62
- Layfield, 1961, *SL-1 Health Physics Data Report No. III*, DR-RO-3; R. L. Layfield; February 15, 1961; SRDB Ref ID: 83775
- Layfield, 1961a, *SL-1 Health Physics Data Report No. IV*, DR-RO-4; R. L. Layfield; February 22, 1961; SRDB Ref ID: 83653
- Legler, 1957, *Startup Operation of a Production Facility for Separating Barium-140 from MTR Fuel*, IDO-14414; B. M. Legler, S. F. Fairbourne, P. N. Kelly, and R. A. Robinson; September 1, 1957; SRDB Ref ID: 136831
- Levine, 1959, *General Operating Rules for Nuclear Testing at the NRTS – ANP Site*, DC-59-4-712; S. J. Levine; April 3, 1959; SRDB Ref ID: 116980
- LOC, 1957-2014, *Idaho National Laboratory Photos*; compilation of links to various photos accessed through the Library of Congress (LOC); SRDB Ref ID: 138147
- Long, 1969, *Fast Burst Reactors*, R. L. Long and P. D. O'Brien; U.S. Atomic Energy Commission, Division of Technical Information; Proceedings of the National Topical Meeting on Fast Burst Reactors; University of New Mexico, January 28-30, 1969; SRDB Ref ID: 136474
- Loop, 1963, *Plutonium Contamination at the Materials Testing Reactor, Conclusions and Recommendations of the Investigating Committee*; E.K. Loop, November 18, 1963; SRDB Ref ID 88068, PDF pp.17, 63-72
- Loop, 1963a, *Plutonium Contamination at the Materials Testing Reactor, Findings of the Investigating Committee*; E. K. Loop, November 18, 1963; SRDB Ref ID: 88068, PDF pp. 40-41

Mahathy, 2015, *Mike Mahathy's OSTI Notes of Gas Analysis Highly Irradiated Be Sample*; Mike Mahathy; 2015; SRDB Ref ID: 141280

Malmstrom, 1972, *Plutonium and Uranium Inhalation Exposures at the Analytical Chemistry Laboratory of the Idaho Chemical Processing Plant*; Carl R. Malmstrom; December 4, 1972; SRDB Ref ID 116077

Mandiloff, 1971, *Phoenix Core Fuel Incident Report, Man-3-71*; D. M. Mandiloff; January 20, 1971; SRDB Ref ID: 140929

McCaslin, 1953, *Radioactive Shipment Monitoring Records January – June 1953*; J. W. McCaslin; SRDB Ref ID: 138870

McCaslin, 1963, *Whole Body Counting Procedures Standard Practices Manual*; 6.24.1; J. W. McCaslin; April 1, 1963; SRDB Ref ID: 132561

McCaslin, 1966, *J. W. McCaslin Correspondence 1966*; J. W. McCaslin; SRDB Ref ID: 126064

McCaslin, 1966a, *J. W. McCaslin Correspondence 1966*; J. W. McCaslin; SRDB Ref ID: 126064, PDF p. 19

McKenna, 1963, *Radioactive Material Shipment Record*; J. H. McKenna; April 26, 1963; SRDB Ref ID: 140429, PDF p. 19

Measurement Procedures, 1983, *Radiologic Field Measurement Procedures*; GJ-09(83); author unknown; July 1983; SRDB Ref ID: 94140

Mills, 1957, *SPERT Incident Report 3-18-57 – 3-22-57*, RLM-8-57A, R. L. Mills; March 29, 1957; SRDB Ref ID: 86640, PDF pp. 2-3

Mills, 1957a, *Multicurie Cell Facility Decontamination*; McV-10-56A; W. H. McVey; August 24, 1956; SRDB Ref ID: 86640, PDF p. 60

Moser, 1985, *RALA Off-Gas Cell and Storage Tank (CPP-631 and VES-702) Decontamination and Decommissioning Plan*, WINCO-1032; C. L. Moser, Westinghouse Idaho Nuclear Company, Inc.; July 1985; SRDB Ref ID: 83550

MTR, 1960s, *Materials Testing Reactor*, Idaho Nuclear Corporation; date unknown, but from context: mid-1960s; SRDB Ref ID: 139250

MTR, 1967, *MTR Phoenix Core*; C. W. Bills, J. R. Horan, E. K. Loop; 1967; SRDB Ref ID: 116086

MTR Progress Report, 1953, *Materials Testing reactor Progress Report*: December 1953, Phillips Petroleum Company; issued January 8, 1954; SRDB Ref ID: 83033, PDF p. 24

Murphy, 1966, *Final Disassembly and Examination of the ML-1 Reactor Core*, IDO-17190; T. L. Murphy, D. R. Schuyler, and W. L. Clarke; issued June 1966; SRDB Ref ID: 141102

Nelson, 1961, Report on the SL-1 Incident, January 3, 1961; author unknown; May 1961; SRDB Ref ID: 4495

Neptunium, 1969, *Neptunium Purification at ICPP*, An-267-69, F. H. Anderson; Idaho Nuclear Corporation; October 9, 1969; SRDB Ref ID: 136643

Neptunium, 1972, *Neptunium-237: Production and Recovery*, ARH-2417, W. W. Schultz; Atlantic Richfield Hanford Company; March 21, 1972; SRDB Ref ID: 105831

Neptunium, 1973, *First Neptunium Processing Campaign at ICPP*, ICP-1019, J. E. Johnson; Allied Chemical Corporation; February 1973; SRDB Ref ID: 130210

Newby, 2000, *Summary of Waste Calcination at the Idaho Nuclear Technology and Engineering Center*, INEEL/EXT-2000-01206; B. J. Newby and B. H. O'Brien; October 2000; SRDB Ref ID: 88549

Notes, 2015, *[Name's redacted] Notes on TRA Progress Reports*, [Name redacted], handwritten notes made during review of TRA Progress Reports regarding various TRA facilities; January 8, 2015; SRDB Ref ID: 140873

NRTS Facilities, 1973, *Tabulation of Facilities at the National Reactor Testing Station*, author unknown; National Reactor Testing Station; July 1973; SRDB Ref ID: 29250

Offutt, 1969, *Rare Gas Recovery Facility at the Idaho Chemical Processing Plant*, IN-1221; G. F. Offutt and C. L. Bendixsen; April 1969; SRDB Ref ID: 136144

OMRE, 1957, *OMRE – Another U.S. Project Under Way*, author unknown; Nuclear Engineering, December 1957; SRDB Ref ID: 139241

OMRE, 1959, *OMRE Radioactive Waste Reports 1959*; author unknown; 1959; SRDB Ref ID: 87001

OMRE, 1961, *Radioisotopic Investigating of OMR Coolants, Part I: OMRE Operation January, 1958 Through August, 1960*; NAA-SR-5049, L. Baumash; Atomics International; December 1, 1961; SRDB Ref ID: 85399

OMRE HP Survey, 1962-1963, *Organic Moderated Reactor Experiment Health Protection Surveys, 1962-1963*; SRDB Ref ID: 71410

ORAUT-OTIB-0005, *Internal Dosimetry Organ, External Dosimetry Organ, and IREP Model Selection by ICD-9 Code*, Rev 05; ORAU Team Dose Reconstruction Project for NIOSH; December 20, 2012; SRDB Ref ID: 121336

ORAUT-OTIB-0006, *Dose Reconstruction from Occupational Medical X-Ray Procedures*, Rev. 04; ORAU Team Dose Reconstruction Project for NIOSH; June 20, 2011; SRDB Ref ID: 98147

ORAUT-OTIB-0011, *Technical Information Bulletin: Tritium Calculated and Missed Dose Estimates*, Rev 00; ORAU Team Dose Reconstruction Project for NIOSH; June 29, 2004; SRDB Ref ID: 19430

ORAUT-OTIB-0014, *Assignment of Environmental Internal Doses for Employees Not Exposed to Airborne Radionuclides in the Workplace*, Rev 00; ORAU Team Dose Reconstruction Project for NIOSH; June 22, 2004; SRDB Ref ID: 19432

ORAUT-OTIB-0017, *Bulletin: Interpretation of Dosimetry Data for Assignment of Shallow Dose*, Rev 01; ORAU Team Dose Reconstruction Project for NIOSH; October 11, 2005; SRDB Ref ID: 19434

ORAUT-OTIB-0018, *Internal Dose Overestimates for Facilities with Air Sampling Programs*, Rev 01; ORAU Team Dose Reconstruction Project for NIOSH; August 9, 2005; SRDB Ref ID: 19436

ORAUT-OTIB-0023, *Technical Information Bulletin: Assignment of Missed Neutron Doses Based on Dosimeter Records*, Rev 01; ORAU Team Dose Reconstruction Project for NIOSH; May 14, 2008; SRDB Ref ID: 43937

ORAUT-OTIB-0033, *Application of Internal Doses Based on Claimant-Favorable Assumptions for Processing as Best Estimates*, Rev 00; ORAU Team Dose Reconstruction Project for NIOSH; April 20, 2005; SRDB Ref ID: 19457

ORAUT-OTIB-0049, *Estimating Doses for Plutonium Strongly Retained in the Lung*, Rev 01 PC-2; ORAU Team Dose Reconstruction Project for NIOSH; November 29, 2010; SRDB Ref ID: 90666

ORAUT-OTIB-0054, *Technical Information Bulletin: Fission and Activation Product Assignment for Internal Dose-Related Gross Beta and Gross Gamma Analyses*, Rev 02; ORAU Team Dose Reconstruction Project for NIOSH; March 6, 2014; SRDB Ref ID: 130852

ORAUT-OTIB-0060, *Internal Dose Reconstruction*, Rev 01; ORAU Team Dose Reconstruction Project for NIOSH; September 8, 2014; SRDB Ref ID: 135808

ORAUT-OTIB-0079, *Guidance on Assigning Occupational X-Ray Dose under EEOICPA for X-Rays Administered Off Site*, Rev 00; ORAU Team Dose Reconstruction Project for NIOSH; January 3, 2011; SRDB Ref ID: 89563

ORAUT-OTIB-0082, *Technical Information Bulletin: Dose Reconstruction Method for Chronic Lymphocytic Leukemia*, Rev 00 PC-1; ORAU Team Dose Reconstruction Project for NIOSH; December 20, 2012; SRDB Ref ID: 121337

ORAUT-PROC-0060, *Procedure: Occupational On-Site Ambient Dose Reconstruction for DOE Sites*, Rev 01; ORAU Team Dose Reconstruction Project for NIOSH; June 28, 2006; SRDB Ref ID: 29986

ORAUT-PROC-0061, *Procedure: Occupational Medical X-Ray Dose Reconstruction for DOE Sites*, Rev 03; ORAU Team Dose Reconstruction Project for NIOSH; March 3, 2010; SRDB Ref ID: 79758

ORAUT-TKBS-0007-1, *Idaho National Laboratory and Argonne National Laboratory-West – Introduction*, Rev. 03; ORAU Team Dose Reconstruction Project for NIOSH; Effective Date: March 12, 2010; SRDB Ref ID: 79862

ORAUT-TKBS-0007-2, *Idaho National Laboratory and Argonne National Laboratory-West – Site Description*, Rev. 04; ORAU Team Dose Reconstruction Project for NIOSH; Effective Date: August 2, 2010; SRDB Ref ID: 84106

ORAUT-TKBS-0007-3, *Idaho National Laboratory and Argonne National Laboratory-West – Occupational Medical Dose*, Rev. 02; ORAU Team Dose Reconstruction Project for NIOSH; Effective Date: December 21, 2009; SRDB Ref ID: 77829

ORAUT-TKBS-0007-4, *Idaho National Laboratory and Argonne National Laboratory-West – Occupational Environmental Dose*, Rev. 02; ORAU Team Dose Reconstruction Project for NIOSH; Effective Date: January 8, 2010; SRDB Ref ID: 78635

ORAUT-TKBS-0007-5, *Idaho National Laboratory and Argonne National Laboratory-West – Occupational Internal Dose*, Rev. 03; ORAU Team Dose Reconstruction Project for NIOSH; Effective Date: March 2, 2010; SRDB Ref ID: 79571

ORAUT-TKBS-0007-6, *Idaho National Laboratory and Argonne National Laboratory-West – Occupational External Dose*, Rev. 03; ORAU Team Dose Reconstruction Project for NIOSH; Effective Date: April 19, 2011; SRDB Ref ID: 94104

Paulus, undated, *Report of Investigation, Criticality Incident at the Idaho Chemical Processing Plant*; R. C. Paulus; undated; SRDB Ref ID: 88441

Perry, 1993, *Minimum Reporting Level for the Idaho National Engineering Laboratory (INEL) Thermoluminescent Dosimetry (TLD) Systems*, EGG-ESQ-10917; O. R. Perry, B. L. Andersen, and P. E. Ruhter; Idaho National Engineering Laboratory; SRDB Ref ID: 8161

Personal Communication, 2014a, *Personal Communication with former INL worker*; In-person interview at Idaho Falls, Idaho by NIOSH and SC&A; November 2014; SRDB Ref ID: Not yet in SRDB

Personal Communication, 2014b, *Personal Communication with former INL worker*; In-person interview at Idaho Falls, Idaho by ORAU Team, ABRWH, SC&A, and NIOSH; November 17, 2014; SRDB Ref ID: Not yet in SRDB

Personal Communication, 2014c, *Personal Communication with former INL worker*; In-person interview at Idaho Falls, Idaho by ORAU Team, ABRWH, SC&A, and NIOSH; November 17, 2014; SRDB Ref ID: Not yet in SRDB

Personal Communication, 2014d, *Personal Communication with former INL worker*; In-person interview at Idaho Falls, Idaho by ORAU Team, Board, SC&A, and NIOSH; November 18, 2014; SRDB Ref ID: Not yet in SRDB

Personal Communication, 2014e, *Personal Communication with former INL worker*; In-person interview at Idaho Falls, Idaho by ORAU Team, Board, SC&A, and NIOSH; November 18, 2014; SRDB Ref ID: Not yet in SRDB

Personal Communication, 2014f, *Personal Communication with former INL worker*; In-person interview at Idaho Falls, Idaho by SC&A and NIOSH; November 18, 2014; SRDB Ref ID: Not yet in SRDB

Personal Communication, 2014g, *Personal Communication with former INL worker*; In-person interview at Idaho Falls, Idaho by ORAU Team, Board, SC&A, and NIOSH; November 18, 2014; SRDB Ref ID: Not yet in SRDB

Personal Communication, 2014h, *Personal Communication with former INL worker*; In-person interview at Idaho Falls, Idaho by ORAU Team, SC&A, and NIOSH; November 20, 2014; SRDB Ref ID: Not yet in SRDB

Personal Communication, 2014i, *Personal Communication with former INL worker*; In-person interview at Idaho Falls, Idaho by ORAU Team and NIOSH; December 11, 2014; SRDB Ref ID: Not yet in SRDB

Peterson, 2004, *Supplement to Technical Basis Document 4 for the Idaho National Engineering and Environmental Laboratory: INEEL Occupational Environmental Dose*, Rev. 0; Henry Peterson; March 9, 2004; SRDB Ref ID: 15451

Petition, 2014, *Special Exposure Cohort Petition - Form B for Idaho National Laboratory*, received by NIOSH on July 18, 2014; DSA Ref ID: 120082

Phillips, 1962, *Phillips Petroleum Company, Atomic Energy Division, Idaho Falls, Idaho*, Operation overview brochure, Phillips Petroleum Company; from context: about 1962; SRDB Ref ID: 139280

Phoenix, 1967, *Significant Unplanned Event*; William C. Phoenix; August 1967; SRDB Ref ID 138999

Picker, 2001, *TAN Hot Shop and Support Facility Utilization Study*, INEEL/EXT-01-01481; B. A. Picker; November 2001; SRDB Ref ID: 136250

Plutonium, 1980, *A Review of the Plutonium Problem in ICPP Facilities and Projects*, M. J. Szulinski; Science Applications, Inc.; April 1980; SRDB Ref ID: 8431

Plutonium in Feces, 1965, *Determination of Plutonium in Feces*; author unknown; July 7, 1965; SRDB Ref ID: 140462

Progress Report, 1968, *Health and Safety Branch Progress Report – 1968*, J. W. McCaslin; Idaho Nuclear Corporation; 1968; SRDB Ref ID: 60289

Progress Reports, 1959, *Health Physics Monthly Progress Reports for 1959*; various authors; various dates throughout 1959; SRDB Ref ID: 85456

Puphal, 1994, *History of the INEL Bioassay Programs*; Puphal; May 2, 1994; SRDB Ref ID: 14664

Redesignation, 1963, *Redesignation of the Army Reactor Experiment Area at the NRTS*, H. N. Eskildson; U. S. Atomic Energy Commission, Idaho Operations Office; July 12, 1963; SRDB Ref ID: 138181

Remediation, 2006, *Remedial Investigating and Baseline Risk Assessment for Operable Unit 7 13/14*, K. J. Holdren; Idaho Cleanup Project; U.S. Department of Energy, Idaho Operations Office; May 2006; SRDB Ref ID: 138535

RFP Waste, 2005, *Historical Background Report for Rocky Flats Plant Waste Shipped to the INEEL and Buried in the SDA from 1954 to 1971*, ICP/EXT-04-00248; North Wind, Inc., TRU Program Technical Services; February 2005; SRDB Ref ID: 83756

Rich, 1958, *Thyroid Exposures from March 1958 Incident at ICPP*; BLR-83-58A; Bryce L. Rich; April 21, 1958; SRDB Ref ID: 8013

Rich, 1974, *Preliminary ICPP Health Physics Upgrade Program*; ACI-167; B. L. Rich; October 1974; SRDB Ref ID: 14667

Rich, 1974a, *CPP-603 Contamination Control Status*, BLR-6-74; B. L. Rich; March 1, 1974; SRDB Ref ID: 118914

Rich, 1979, *1978 Health Physics Annual and Upgrade Status Report*, BLR-10-79; B. L. Rich; May 3, 1979; SRDB Ref ID: 124517

Robertson, 1982, *Brief History of GE at INL and Disposition of Records*; D. C. Robertson; March 26, 1982; SRDB Ref ID: 90564

Ruhter, 2002, *Idaho National Engineering and Environmental Laboratory (INEEL) Dosimetry Systems History and Minimum Dose Reporting Level (MRL) Information (External Dose Summary Profile – 1951 to March 2002)*, P. E. Ruhter and O. R. Perry; Bechtel BWXT Idaho, Idaho National Engineering and Environmental Laboratory; April 8, 2002; SRDB Ref ID: 1774, PDF p. 2

RWMC History, 1979, *A History of the Radioactive Waste Management Complex at the Idaho National Engineering Laboratory*; PR-W-79-038; B. C. Anderson; Operations Project, Waste Management Programs, EG&G Idaho, Inc.; SRDB Ref ID: 83011

RWMC History, 1985, *A History of the Radioactive Waste Management Complex at the Idaho National Engineering Laboratory*; WM-F1-81-003, Rev. 3; author unknown; Waste Program Division, RWMC Operations Branch; July 1985; SRDB Ref ID: 83913; SRDB Ref ID: 124478

TAN Shipments, 1963-64, *Radioactive Material Shipment Records for TAN, 1963-64*, various authors and dates; Idaho National Laboratory; SRDB Ref ID: 138229

SABER, 1990, *Steam Accumulator Blowdown Evaluation Rig Large Scale Steam Valve Test Action Description Memorandum*; author unknown; SRDB Ref ID: 139732

Savignac, 1961, *CFA Health Physics Monthly Report for September, 1961*; Sav-12-61A; Bart Savignac; October 24, 1961; SRDB Ref ID: 139258

Savignac, 1961a, *CFA Health Physics Monthly Report for July, 1961*; Sav-9-61A; Bart Savignac; August 11, 1961; SRDB Ref ID: 139258, PDF p. 13

Savignac, Jul1961, *CFA Health Physics Monthly Report for July, 1961*, Sav-9-61A; Bart Savignac; August 11, 1961; SRDB Ref ID: 138196

Savignac, 1963, *Monthly Burial Ground Report*; Sav-11-63A; B. F. Savignac; May 8, 1963; SRDB Ref ID: 139220

Sauvignac, 1963a, *Monthly Burial Ground Report October – December 1962*; Bart Sauvignac; 1962-1963; SRDB Ref ID: 138684

Shank, 1964, *Annual Report of Division Analytical Branch for 1963*; IDO-14636; Ralph C. Shank; June 1964; SRDB Ref ID: 138063

Shank, 1969, *Analytical Chemistry Branch Annual Report Fiscal Year 1969*; IN-1316; R. C. Shank; September 1969; SRDB Ref ID: 136032

Shipment Records, 1960s, *Radioactive Shipment Records for U-235, Mixed Fission Products and Contaminated Respirators*, U.S. Atomic Energy Commission, Idaho Operations Office; various authors; various dates in early 1960s; SRDB Ref ID: 139190

SL-1 Chronology, 1961, *SL-1 Chronology, January through April 1961*, author unknown; Idaho National Laboratory; February 2, 1961; SRDB Ref ID: 83755

SL-1 Final, 1962; *Final Report of SL-1 Recovery Operation*, IDO-19311; author unknown, July 27, 1962; SRDB Ref ID: 140097

SL-1 IDO Report, 1962, *IDO Report on the Nuclear Incident at the SL-1 Reactor January 3, 1961 at the National Reactor Testing Station*; IDO-19302; author unknown; January 1962; SRDB Ref ID: 85418

SL-1 Records, 2009, *Historical Information for SL-1 (Accident Records)*, SL-1 accident response timeline, observations, log entries, badge reports, dosimetry reports and misc. documents gathered in 2009 by ORAU Team; SRDB Ref ID: 59343

SL-1 Report, 1961, *Report on the SL-1 Incident, January 3, 1961*, C. A. Nelson; U.S. Atomic Energy Commission Board of Investigation; May 1961; SRDB Ref ID: 4495

SL-1 Safety, 3Q-1959, *ABWR Quarterly Progress Report, Volume II, SL-1 Health Physics & Safety, July 1 to September 30, 1959*, IDO-19005, E. J. Vallario; Combustion Engineering; October 15, 1959; SRDB Ref ID: 8142

SL-1 Safety, 4Q-1959, *ABWR Quarterly Progress Report, Volume II, SL-1 Health Physics & Safety, October 1 to December 31, 1959*, IDO-19009, E. J. Vallario; Combustion Engineering; January 15, 1960; SRDB Ref ID: 140236

SL-1 Safety, 1Q-1960, *ABWR Quarterly Progress Report, SL-1 Health Physics & Safety, January 1 to March 31, 1960*, IDO-19013, R. T. Canfield; Combustion Engineering; May 25, 1960; SRDB Ref ID: 135863

SL-1 Safety, 2Q-1960, *ABWR Quarterly Progress Report, SL-1 Health Physics & Safety, April 1 to June 30, 1960*, IDO-19017, W. B. Allred; Combustion Engineering; August 12, 1960; SRDB Ref ID: 102428

SL-1 Sr-90 Dose, 1961, *Probable Strontium-90 Dose of Personnel Involved with SL-1 Incident, January 3, 1961*, E. R. Ebersole; Analysis Branch, Health and Safety Division, Idaho National Laboratory; document date unknown; SRDB Ref ID: 31960

Smith, 1981, *Characterization of the RALA Off-Gas Cell, CPP-631*, WM-F1-81-010; D. L. Smith and D. J. Bradford; May 1981; SRDB Ref ID: 31990

SNAPTRAN, 1964, *SNAPTRAN 2/10A-3 Program*, Doc. No. 726881, Idaho National Laboratory; May 1964; SRDB Ref ID: 136013

SNAPTRAN, 1967, *SNAPTRAN-2 Destructive Test Results*, IDO-17194, W. E. Kessler; Phillips Petroleum Company; January 1967; SRDB Ref ID: 140002

Sommers, 1956, *Radioactivity Incident Reports, John F. Sommers, January 1956*; SRDB Ref ID: 139301, PDF pp. 60-69

Sommers, 1957, *Crystal Spectrometer Incident – 12-11-57*; Som-122-57A; John F. Sommers; December 13, 1957; SRDB Ref ID: 85448, PDF pp. 104-105

Sommers, 1957a, *Hot Cell Contamination Incident on March 8, 1957*; Som-34-57A; John Sommers; March 29, 1957; SRDB Ref ID: 86568, PDF pp. 18-20, 105-108

Sommers, 1959, *Radioactive Shipment Record Details of Shipment MTR Hot Laundry December 1959*; John Sommers; SRDB Ref ID: 138144

Sommers, 1959a, *MTR Health Physics Program Report for August, 1959*; Som-80-59A; John F. Sommers; September 16, 1959; SRDB Ref ID: 87081, PDF p. 23

Sommers, 1961, *Whole Body Counting Procedures for MTR-ETR HP's*; Som-106-61A-M; John F. Sommers; September 27, 1961; SRDB Ref ID: 8545

Sommers, 1963, *Plutonium Contamination Incident at the TRA November 13-18, 1963*; John F. Sommers; undated; SRDB Ref ID: 87466

Sommers, 1966, *Whole Body Counting*; Som-44-66; John F. Sommers; September 6, 1966; SRDB Ref ID: 32048

Sommers, 1968, *TRA Routine Whole Body Counts in 1968*; Som-5-68; John F. Sommers; January 11, 1968; SRDB Ref ID: 32054

Special HP Services, 1968, *Idaho Nuclear Corporation Standard Practice No. 6.20.2, Special HP Services*, F. A. Anderson; Idaho Nuclear Corporation; October 17, 1968; SRDB Ref ID: 141098

SPERT, 1957, *Various SPERT Activity Release Reports for 1957*; Phillips Petroleum Company; various dates throughout 1957; SRDB Ref ID: 31877

SPERT and SNAPTRAN, 1960s, *Source Term Quality Control Tasks (Episodic Releases)*, DOE/ID-12119-QAF-014 6- 018, assorted documents from 1991 focused on SPERT events in the 1960s; also includes SNAPTRAN events; various authors; Idaho National Laboratory; various dates; SRDB Ref ID: 88727

SPERT-I, 1961, *Special Power Excursion Reactor Tests (SPERT), General Information, Fact Sheet on SPERT-I*, Phillips Petroleum Company; April 2, 1961; SRDB Ref ID: 136955

SPERT-I, 1965, *SPERT I Destructive Test Series Environmental Monitoring and Research Studies*, IDO-12039, D. F. Bunch; Idaho Operations Office, U.S. Atomic Energy Commission; January 1965; SRDB Ref ID: 83580

SPERT-I, -II, and -III, 1957, *Summary of the SPERT-I, -II, and -III Reactor Facilities*, C. R. Montgomery; Phillips Petroleum Co.; November 1, 1957; SRDB Ref ID: 136833

SPERT-III, 1961, *SPERT III Reactor Facility*, R. E. Heffner; National Reactor Testing Station, U.S. Atomic Energy Commission; October 25, 1961; SRDB Ref ID: 139856

SPERT-IV, 1962, *SPERT IV Facility*, IDO-16745, R. E. Heffner, Phillips Petroleum Company; February 22, 1962; SRDB Ref ID: 139885

SPERT Dosimetry, 1957-58, *Various SPERT Documents Regarding Dosimetry*, various authors and dates from January 2, 1957 to October 7, 1958; Idaho National Laboratory; SRDB Ref ID: 140361

SPERT Program, 1957, *SPERT Program Review*, W. E. Nyer; Phillips Petroleum Co.; September 27, 1957; SRDB Ref ID: 136953

SPERT Tests, 1965, *Special Power Excursion Reactor Tests*, Phillips Petroleum Company; August 13, 1965; SRDB Ref ID: 116091

Stacy, 1995, *Historical American Engineering Record, Idaho National Engineering Laboratory, Test Area North, Hangar 629, HAER No. ID-33-A*; Susan Stacy; August 12, 1995; SRDB Ref ID: 136966

Stacy, 2000, *Proving the Principle*, DOE/ID-10799; Susan M. Stacy, Idaho Operations Office of the Department of Energy; Published in 2000; SRDB Ref ID: 1152

Stacy, 2000a, *Proving the Principle*, DOE/ID-10799; Susan M. Stacy, Idaho Operations Office of the Department of Energy; Published in 2000; SRDB Ref ID: 1152, PDF p. 279

Stacy, 2000b, *Proving the Principle*, DOE/ID-10799; Susan M. Stacy, Idaho Operations Office of the Department of Energy; Published in 2000; SRDB Ref ID: 1152, PDF p. 274

Stacy, 2006, *Historic American Engineering Record, Idaho National Laboratory, Idaho Chemical Processing Plant, Fuel Reprocessing Complex*, INL/EXT-06-11969; Susan Stacy and Julie Braun; December 2006; SRDB Ref ID: 80142

Stroschein, 1967, *Health Physics Manual of NRTS Areas Operated by Idaho Nuclear Corporation*; edited by H. W. Stroschein and P. H. Maeser; Issued: April 1967; SRDB Ref ID: 1029

Survey, Aug-Dec1953, *Alpha Smear Surveys (August-December 1953)*; August 31-December 16, 1953; SRDB Ref ID: 138873

Survey, May-Jun1955, *Alpha Smear Surveys (May-June 1955)*; May 26-June 30, 1955; SRDB Ref ID: 138871

Survey, Oct1955, *Alpha Smear Surveys for Main Floor, Reactor Basement, Labs 106, 107, 109, 112, and 113 (October 1958)*; October 9-25, 1955; SRDB Ref ID: 138724

Survey, Jun1958, *Alpha Beta Gamma Surveys (June 1958)*; June 1-30, 1958; SRDB Ref ID: 138681

Survey, Nov1958, *Alpha Surveys (November 1958)*; November 1-30, 1958; SRDB Ref ID: 138688

Survey, Apr1963, *MTR Health Physics Survey Logs (April 1963)*; April 1-30, 1963; SRDB Ref ID: 140256

Survey, Jul1963, *HP Logbook Sheets MTR with Total Daily Swipe Counts and Beta and Gamma Surveys (July 1963)*; July 1-31, 1963; SRDB Ref ID: 140359

Survey, Aug1968, *MTR Contamination Surveys (August 1968)*; August 1-31, 1968; SRDB Ref ID: 140292

Survey, Apr1969, *MTR HP Survey Logs (April 1969)*; March 31-April 30, 1969; SRDB Ref ID: 140315

Surveys, 1968, *Floor Plan Surveys July 1968*; author unknown; 1968; SRDB Ref ID: 138812

SWP 1962-1964, *Safe Work Permit Burial Ground January 1962 – December 1964*; author unknown; 1962-1964; SRDB Ref ID: 138194

TAN Alpha Survey, 1968, *Test Area North Alpha Survey, Hot Cell Area*; W. Anderson; June 4, 1968; SRDB Ref ID: 140265, PDF p. 119

TAN HP Report, Dec1963, *TAN Health Physics Report for December, 1963*, O. L. Cordes; Phillips Petroleum Company, Atomic Energy Division, Idaho Falls, Idaho; January 9, 1964; SRDB Ref ID: 138714

TAN Monitoring, 1963, *Tan Area Monitoring Schedule*; author unknown; March 1963; SRDB Ref ID: 140265, PDF p. 105

Terch, 1963, *SPERT Health Physics Monthly Report for August, 1963*, Ter-10-63A; L. P. Terch; September 10, 1963; SRDB Ref ID: 138710

Thorium, 1961, *Remote Dissolution and Analytical Program for Irradiated Thorium*, IDO-14557, G. A. Huff; Phillips Petroleum Company; July 14, 1961; SRDB Ref ID: 133336

Thornton, Feb1962, *Comprehensive Technical Report – General Electric Direct-Air-Cycle Aircraft Nuclear Propulsion Program, Heat Transfer Reactor Experiment No. 1*, APEX-904; G. Thornton, S. H. Minnich, C. Heddleson, and D. H. Culver; February 28, 1962; SRDB Ref ID: 84049

Thornton, Jun1962, *Comprehensive Technical Report – General Electric Direct-Air-Cycle Aircraft Nuclear Propulsion Program, Program Summary and References*, APEX-901; G. Thornton and A. J. Rothstein; June 28, 1962; SRDB Ref ID: 1078

Tiger Team, 1991, *Tiger Team Assessment of the Idaho National Engineering Laboratory Volume 2, Section 4.0*; author unknown; 1991; SRDB Ref ID: 77146

Tingey, 1968, *Qualification of Umpire Laboratories for the Analysis of Uranium and Plutonium Materials Specifications Report 1, Basic Programs*; F. H. Tingey; May 1968; SRDB Ref ID: 139246

Uranium, 1957, *Determination of Uranium in Irradiated Thorium*, IDO-14411, B. E. Paige; Phillips Petroleum Co.; June 19, 1957; SRDB Ref ID: 139893

Uranium, 1966, *Uranium Recovery from Aluminum Alloyed Fuel, ICPP Run No. 21*, IDO-14669, B. R. Wheeler; Phillips Petroleum Company; January 1966; SRDB Ref ID: 133346

Voelz, 1969, *1968 Annual Report of the Health Services Laboratory*, IDO-12071; George L. Voelz and multiple other authors; April 1969; SRDB Ref ID: 1359

Voelz, 1970, *1969 Annual Report of the Health Services Laboratory*, IDO-12073; George L. Voelz and multiple other authors; July 1970; SRDB Ref ID: 1362

Waste Management, 1974, *ID Waste Management Plan for FY 1975: National Reactor Testing Station*; Office of Waste Management, Idaho Operations Office, U.S. Atomic Energy Commission; July 1974; SRDB Ref ID: 139837

Waste Shipments, Feb1963, *Disposal of Off-Site Radioactive Waste – Shipment Data Forms*, Phillips Petroleum Company; various dates in February 1963; SRDB Ref ID: 139231

Waste Shipments, Mar1963, *Disposal of Off-Site Radioactive Waste – Shipment Data Forms*, Phillips Petroleum Company; various dates in March 1963; SRDB Ref ID: 139232

Waste Shipments, Apr1963, *Disposal of Off-Site Radioactive Waste – Shipment Data Forms*, Phillips Petroleum Company; various dates in April 1963; SRDB Ref ID: 139233

Waste Shipments, May1963, *Disposal of Off-Site Radioactive Waste – Shipment Data Forms*, Phillips Petroleum Company; various dates in May 1963; SRDB Ref ID: 139234

Waste Shipments, Jun1963, *Disposal of Off-Site Radioactive Waste – Shipment Data Forms*, Phillips Petroleum Company; various dates in June 1963; SRDB Ref ID: 139235

Waste Shipments, Jul1963, *Disposal of Off-Site Radioactive Waste – Shipment Data Forms*, Phillips Petroleum Company; various dates in July 1963; SRDB Ref ID: 139236

Waste Shipments, Aug1963, *Disposal of Off-Site Radioactive Waste – Shipment Data Forms*, Phillips Petroleum Company; various dates in August 1963; SRDB Ref ID: 139237

Waste Shipments, Nov1963, *Disposal of Off-Site Radioactive Waste – Shipment Data Forms*, Phillips Petroleum Company; various dates in November 1963; SRDB Ref ID: 139238

WBC1, 1961-1977, *INEL Whole Body Count CD 1 of 5*; SRDB Ref ID: 123105

WBC2, 1963-1995, *INEL Whole Body Count CD 2 of 5*; SRDB Ref ID: 123113

WBC3, 1981-1994, *INEL Whole Body Count CD 3 of 5*; SRDB Ref ID: 123114

WBC4, 1979-1995, *INEL Whole Body Count CD 4 of 5*; SRDB Ref ID: 123115

WBC5, 1973-1996, *INEL Whole Body Count CD 5 of 5*; SRDB Ref ID: 123116

Wenzel, 1973, *Internal Pu Doses*; Wen-2-73; D. R. Wenzel; July 24, 1973; SRDB Ref ID: 8014

Wenzel, 1973b, *Internal Doses Resulting from ICPP Analytical Chemistry Laboratory Plutonium Contamination Occurrence*, correspondence with attached report; D. R. Wenzel; July 24, 1973; SRDB Ref ID: 1231

Willis, 1959, *CAM Filter Counting Procedure*; CLW-3-59A-N; C. L. Willis; August 19, 1959; SRDB Ref ID: 124536, PDF p.50

Attachment 1: Data Capture Synopsis

Table A1-1: Data Capture Synopsis for Idaho National Lab			
Data Capture Information	General Description of Documents Captured	Date Completed	Uploaded To SRDB
<p><u>Primary Site/Company Name:</u> Idaho National Laboratory (INL) DOE 1949 - Present</p> <p><u>Alternate Site Names:</u> National Reactor Testing Station Idaho National Engineering Laboratory Idaho National Engineering and Environmental Laboratory</p> <p><u>Physical Size of the Site:</u> 892 square miles</p> <p><u>Site Population:</u> 4,100 in 2010</p>	<p>Routine blood sampling, incident reports, environmental reports, SL-1 reports, internal dosimetry programmatic documents, Aircraft Nuclear Propulsion reports, dosimetry report area codes, uranium urinalysis using the KPA laser, neutron dose rates, building lists, site telephone directories, individual medical records, individual dosimetry reports, offsite environmental surveillances, onsite environmental surveillances, monitoring and modeling effluent releases, extracting radionuclides from product streams, occupational and environmental air sampling data, periodic Health Physics reports, periodic facilities reports, tritium reports, safety analyses for facilities and campaigns, surveys of specific areas with high radionuclide concentrations, ecological reports, contamination control plans, logbooks, bioassay result sheets, temporary badge reports, correspondence files, Idaho Chemical Processing Plant (ICPP) routine surveys, Health Physics log sheets, safe work permits, annual exposure records, Health and Safety Record Sheets, periodic operations and technical reports, irradiated thorium reports, waste handling reports, shipping reports, air filter spectra, and analytical methods. NOTE: Awaiting documents to be released from INL.</p>	OPEN	3,449
State Contacted: NA	Since INL is an operating DOE facility the state was not contacted.	01/30/2015	0
Albany Research Center (ARC)	Fluorometric determination of uranium in air dusts and smears, INL work performed at ARC, a study on melting wastes, and the disposal of solid packaged waste.	03/20/2013	4
Argonne National Laboratory (ANL)	The 2004 ANL EEOICPA Reasonable Search Procedures, decontamination of plutonium contaminated gloveboxes, and monthly Operation Clean Sweep status reports from 1982.	03/26/2008	3
Battelle Memorial Institute - King Avenue	Battelle reactor decommissioning core materials shipped to INL and 1955-1956 applications to obtain radioisotopes.	08/18/2014	3
Brookhaven National Laboratory	Ambient air monitoring at DOE facilities, the development of a single unit beta-gamma extremity dosimeter, identification of INL as the repository for the High Flux Beam Reactor spent fuel, and accelerator and medical reactor radiation exposures.	11/14/2008	5

Table A1-1: Data Capture Synopsis for Idaho National Lab			
Data Capture Information	General Description of Documents Captured	Date Completed	Uploaded To SRDB
Cincinnati Public Library	A 1974 history of the Atomic Energy Commission.	02/10/2011	1
Claimant Provided	A petition on the Nuclear Regulatory Commission's oversight of mill tailings that refers to INL, the inter-agency reports on links between exposure to hazards and illnesses in the DOE contractor workforce, and the explosive demolition of the Organic Moderated Reactor Experiment building foundation.	11/26/2013	3
Colorado Mesa University, Tomlinson Library	ICPP waste inventories and properties, removal of radionuclides from waste evaporator condensates, and the pilot plant operation of a geometrically safe denitrator at the ICPP.	10/15/2012	3
Colorado State University	A 1986 decontamination and waste treatment facilities assessment.	04/10/2006	1
Curtiss-Wright, Cheswick, PA	The Liquid Metal Fast Breeder Reactor Program, an INL request for quotation on plutonium pellets, and shipping information 1968-1972.	04/24/2009	3
Dade Moeller	External and internal dosimetry records, radiation incident reports and dosimetry, air monitoring data, effluent releases, bus survey data, surveillances, whole body counts and scheduling, and a records clean out campaign.	04/24/2009	92
Dade Moeller / SC&A	Sample thyroid counts, release reports, incident reports, monthly Health Physics reports, and waste reports.	03/19/2007	11
DOE Albuquerque	Description of INL facility for storing Pantex components.	04/13/2010	1
DOE Environmental Management Consolidated Business Center (EMCBC), Denver	The 1989 Performance Indicator Pilot Program.	08/15/2013	1
DOE Germantown	A 1958 trip report, Mallinckrodt airport waste, the DOE Legacy Management process to respond to EEOICPA claims, search procedures for the DOE Oak Ridge Operations Records Holding Area, the 2010 ANL EEOICPA Reasonable Search Procedures, and a NIOSH researcher's notes from a Germantown classified document review.	03/18/2014	6
DOE Idaho Operations Office	DOELAP external dosimetry reports, survey reports, photographs of film packs, film calibrations, dosimeters, Bonner spheres, neutron cards, and summary descriptions of film calibration curves and area photographs.	12/20/2013	34
DOE Legacy Management - Grand Junction Office	INL's handling of transuranic waste, a CPAF report, waste management, uranium scrap shipments, a 1964 site map with off-site environmental monitoring data, bioassay data, programmatic internal dosimetry documents, environmental monitoring reports, development of reference materials, and an index to reactor fuel data sheets.	08/25/2011	31

Table A1-1: Data Capture Synopsis for Idaho National Lab			
Data Capture Information	General Description of Documents Captured	Date Completed	Uploaded To SRDB
DOE Legacy Management - Morgantown	Grand Junction Facilities dosimetry reports provided by INL, recycled uranium reports, exposure investigations, and an assessment of health and mortality studies.	04/16/2013	105
DOE Legacy Management - MoundView (Fernald Holdings, includes Fernald Legal Database)	Feed Materials Production Center reports referring to INL, unusual occurrence reports, DOE suspends shipments of low-level waste to commercial burial grounds, a bioassay conference, a safety analysis report for plutonium repackaging, an investigation of a high radiation exposure, 1976 Mound transuranic shipments to INL, and the codes for the Idaho Operations Office and INL contractors.	09/01/2008	37
DOE Legacy Management - Westminster	The 2003 analysis of external dosimetry across the DOE Complex, a Rocky Flats author list, and INL as a QA laboratory for the Rocky Flats bioassay program.	07/24/2013	3
DOE Oak Ridge Operations Office	Internal audit criteria for industrial hygiene, radiation exposure records 1954-1968, U-233 disposition strategies and options, and an article on radiation injuries.	07/09/2012	5
DOE Oak Ridge Operations Office - RHTG	An INL shipment to the Portsmouth Gaseous Diffusion Plant and early AEC Production Division reports.	06/25/2013	7
DOE Office of Scientific and Technical Information (OSTI)	Report on surveys of irradiation facilities, stable isotope and heavy element inventories, radioisotope inventories, Health Physics reports, reports of shipments, the first neptunium processing campaign, U-233 in irradiated thorium, dosimetry service performance testing, particulate diffusion near buildings, and the MESODIF-II description and code.	01/21/2015	37
DOL - Paragon	Mixed waste inventory characteristics, Organic Moderated Reactor Experiment (OMRE) evaluations, and transcripts of the National Academies of Science committee meetings on remediation of buried waste.	01/23/2012	5
East Tennessee Technology Park (ETTP) Records Center	Report confirming the routing of some recycled uranium through the ICPP.	06/05/2014	1
Federal Records Center (FRC) - Atlanta	The 1986 Effluent Information System (EIS)/Onsite Discharge Information System (ODIS) executive summary.	03/16/2004	1
Federal Records Center (FRC) - Boston	Personnel termination exposure summaries.	04/27/2012	1
Federal Records Center (FRC) - Chicago	Personnel monitoring records.	09/29/2008	2
Federal Records Center (FRC) - Denver	Mixed waste streams, a review of criticality accidents, a 1995 DOE occupational exposure report, Photodosimetry Evaluation Book Volume IV, and the transfer of the tritium plasma experiment glovebox to INL.	01/31/2012	5

Table A1-1: Data Capture Synopsis for Idaho National Lab			
Data Capture Information	General Description of Documents Captured	Date Completed	Uploaded To SRDB
Federal Records Center (FRC) - Kansas City	Argonne National Laboratory (ANL) fuel cycle and waste management field work proposals and agreements.	08/15/2008	1
Federal Records Center (FRC) - San Bruno	Operations reports, equipment development reports, Health Physics reports, and bioassay procedures.	08/03/2012	16
General Atomic	An SL-1 accident report, 1960-1964 radiation injury claims, material shipping and status reports, and GAMAS Trailer exposures at INL.	01/10/2006	5
General Electric (GE) - Evendale	The history of GE at INL and the disposition of records.	11/12/2010	1
Hagley Museum & Library	Mention of INL as a major liquid waste producer and a trip report to ANL.	09/28/2010	2
Hanford	AEC operational accidents and radiation exposures 1943-1970, an SL-1 report, Hanford operational reports, neptunium production and recovery, material balance and transaction reports, and DOE comments on the Environmental Protection Agency's proposed hazardous waste management system.	01/17/2013	29
Hanford / S. Cohen & Associates (SC&A)	A routine fecal sampling program for plutonium workers.	08/05/2004	1
[Name Redacted]	A dosimetry system intercomparison report.	08/13/2003	1
Idaho National Laboratory / SC&A	Incident reports, Initial Engine Test reports, stack monitoring description and data, and 1985 TLD and air monitoring data for the Radioactive Waste Management complex (RWMC).	06/05/2012	14
Interlibrary Loan	A 1973 criticality short course, 1958 uranium ore processing, environmental reports, INL participation in a tritium plasma experiment, and ICPP technical progress reports.	01/13/2015	28
Internet - Defense Technical Information Center (DTIC)	Annual reports to Congress on activities relating to the Defense Nuclear Facilities Safety Board (DNFSB), plutonium stabilization, waste treatment reports, irradiation reports, and radiochemical constituents of aqueous effluents. This database has not been searched in its entirety.	OPEN	18
Internet - Defense Technical Information Center (DTIC) / SC&A	A 1995 site environmental report.	01/09/2012	1
Internet - DOE	The standard of good radiological protection practices in plutonium facilities and experimental data for release fractions from nonreactor facilities.	12/04/2008	2
Internet - DOE Comprehensive Epidemiologic Data Resource (CEDR)	This database has not been searched in its entirety.	OPEN	0
Internet - DOE Environmental Management	Linking Legacies Chapter 3: Wastes.	10/28/2007	1

Table A1-1: Data Capture Synopsis for Idaho National Lab			
Data Capture Information	General Description of Documents Captured	Date Completed	Uploaded To SRDB
Internet - DOE Hanford DDRS	Hanford monthly reports referencing INL, criticality considerations and loads forecasts for ICPP, material shipments, and plutonium for the Zero Power Physics Reactor (ZPPR).	06/06/2013	40
Internet - DOE Legacy Management	INL decontamination and decommissioning technology logic diagrams and a DOE mixed waste report.	09/19/2014	3
Internet - DOE Legacy Management Considered Sites	Materials packaging and shipping reports and a mixed waste report.	12/29/2014	3
Internet - DOE National Nuclear Security Administration (NNSA) - Nevada Site Office	No relevant data identified.	09/19/2012	0
Internet - DOE Oak Ridge Operations Office	An interim action report for fuel and flush salt removal from the Oak Ridge National Laboratory (ORNL) molten salt reactor experiment.	01/14/2014	1
Internet - DOE OpenNet	Incident reports, interviews, environmental branch reports, aircraft nuclear propulsion reports, SNAPTRAN reports, Health Physics reports, iodine skin absorption reports and consent documents, SPERT reports, and 1961 site radiation protection standards.	12/29/2014	86
Internet - DOE OpenNet / Hanford	A human radiation studies interview.	11/26/2007	1
Internet - DOE OpenNet / NIOSH	A 1960 annual report to Congress.	01/11/2008	1
Internet - DOE OSTI	The Tiger Team Assessment of INL, 1965 and 1969 waste disposal data, and a nuclear waste management report.	11/11/2013	6
Internet - DOE OSTI Energy Citations	Characterization of transuranic waste, nuclear fuel development and research reports, fuel transfers, facility descriptions, external dosimetry reports, environmental surveys and assessments, mixed waste assessments, effluent monitoring, ICPP upgrade evaluations, Nevada Test Site shipment reports, thorium utilization report, reactor core experiments, advanced neutron source report, reactor operations procedures, nuclear air cleaning conference proceedings, and detection of highly-enriched uranium.	05/07/2013	100
Internet - DOE OSTI Energy Citations / SC&A	A 1966 controlled environmental radioiodine test.	04/29/2010	1

Table A1-1: Data Capture Synopsis for Idaho National Lab			
Data Capture Information	General Description of Documents Captured	Date Completed	Uploaded To SRDB
Internet - DOE OSTI Information Bridge	Integrated spent fuel and radioactive waste inventories, environmental reports to Congress, interviews, waste generation reports, reactor fuel reports, annual DOE radioisotope customer and shipment reports, environmental reports, ZPPR progress reports, continuous detection of airborne Pu-239, spent fuel treatment, decontamination and decommissioning reports, air emission reports, radiological control performance indicator reports, transuranic control reports, ICPP research reports, properties of Rocky Flats vitrified transuranic waste, disposal of high level waste at the ICPP, handling ICPP high level waste, EBR-II reports, U-233 recovery, neptunium processing, and low level waste transportation.	08/13/2013	498
Internet - DOE OSTI Information Bridge / SC&A	A 1954 BORAX experiment Health Physics report.	07/06/2007	1
Internet - DOE OSTI SciTech Connect	The INEL historical dose evaluation-reconstruction of airborne releases, chemical processing technology periodic reports, technical progress reports, analytical branch reports, safety analyses reports, Advanced Test Reactor (ATR) radiological monitoring results, ATR waste reports, instrument branch reports, analyses of irradiated materials, ICPP waste handling and management reports, fuels and materials reports, metals and ceramics reports, environmental reports, air emissions reports, and mixed waste processing reports.	01/13/2015	427
Internet - Energy Employees Claimant Assistance Project (EECAP)	Compendium of federal and state radioactive materials transportation laws and regulations and Arco, Idaho soil samples. This database has not been searched in its entirety.	OPEN	2

Table A1-1: Data Capture Synopsis for Idaho National Lab			
Data Capture Information	General Description of Documents Captured	Date Completed	Uploaded To SRDB
Internet - Google	Environmental reports, ABRWH meeting minutes, waste reports, nuclear nonproliferation reports, U-233 storage safety, DOE radioisotope customers, DOE occupational exposure reports, INL history and photographs, waste shipments, reports to Congress, environmental impact statements, a 2004 union agreement, a comprehensive RWMC waste inventory and projection, Aircraft Nuclear Propulsion reports, SL-1 reports, radionuclide releases, environmental behavior of radionuclides, air sampling, remediation conceptual designs, EPA records of decision, facility descriptions, risk assessments, INL oversight reports, ICPP operational reports, instrument and equipment instructions and reports, Rocky Flats transuranic waste reports, estimating releases of various radionuclides, radionuclide releases, and planning for the long term storage of high level ICPP waste.	09/22/2014	785
Internet - Hathitrust	ICPP technical progress reports.	12/02/2014	4
Internet - Health Physics Journal	Health Physics aspects of the SL-1 accident, environmental reports including intakes by indigenous animal species, iodine monitoring, the rem response of the INL personnel dosimeter to photons, and application of ALARA to the high level waste tank closure project. This database has not been searched in its entirety.	OPEN	15
Internet - Journal of Occupational and Environmental Hygiene	This database has not been searched in its entirety.	OPEN	0
Internet - National Academies Press (NAP)	Waste treatment and disposition, plutonium treatment and disposition, radionuclide releases, review of DOE's cleanup roadmap, and cancer risks to adjacent populations.	12/29/2014	11
Internet - National Institute for Occupational Safety and Health (NIOSH)	Residual beryllium contamination reports, a review of Initial Engine Test source terms, and the epidemiologic study of mortality and cancer risk at INL	11/02/2011	5
Internet - NRC Agencywide Document Access and Management (ADAMS)	A FOIA response for Westinghouse Electric, waste reports, spent nuclear fuel management, plutonium and highly-enriched uranium management, weapons-usable material disposition environmental impact statement and studies, LOFT experiment reports, studies on environmental transport, environmental reports, NRC reviews of INL remediation plans, facility safety assessments, and accident scenario assessments.	12/29/2014	205

Table A1-1: Data Capture Synopsis for Idaho National Lab			
Data Capture Information	General Description of Documents Captured	Date Completed	Uploaded To SRDB
Internet - Oak Ridge National Laboratory (ORNL)	ORNL division progress reports referencing INL and summary of transuranic waste assay methods used by INL.	04/08/2013	102
Internet - University of Hawaii, Manoa	A 1965 aerial survey of the National Reactor Testing Station.	11/08/2007	1
Internet - University of North Texas	A reactor engineering division quarterly report, extraction study reports, summary of the SPERT reactor facilities, Army gas-cooled reactor periodic reports, hazards summary reports, a SNAPTRAN safety analysis, and the microfilm system for engineering drawings.	11/11/2014	29
Internet - US Army Corps of Engineers (USACE)	No relevant data identified.	12/29/2014	0
Internet - US Environmental Protection Agency NEPIS	Superfund records of decision, environmental I-129, and 1987 mixed energy waste studies.	12/29/2014	15
Internet - US Transuranium and Uranium Registries	A mortality and longevity report on workers exposed to plutonium.	12/29/2014	1
Kansas City Plant	Radiation exposure records and personal dosimeter procedures.	10/09/2013	5
Lawrence Livermore National Laboratory	Request for approval to ship Tory II-A fuel elements.	08/02/2014	1
Los Alamos National Laboratory	Photodosimetry Evaluation Book "Bible" Volume VIII Procedures 1996-2001 (LANL 2001b) and radioactive waste disposal issues.	11/29/2006	2
Los Alamos National Laboratory - LAHDRA	Waste projections, characteristics of mixed waste streams, and storage and disposition of weapons-usable material.	12/13/2007	6
Missouri Department of Natural Resources	Plutonium Working Group reports.	10/01/2008	3
Mound Museum	Bismuth reports, weapons production, waste management, and Mound publications referencing INL.	02/01/2012	13
National Archives and Records Administration (NARA) - Atlanta	A Materials Testing Reactor report, accident report summaries, a National Reactor Testing Station information packet, the DOE indoor radon study, and directory of consultants.	05/23/2008	12
National Archives and Records Administration (NARA) - Atlanta / SC&A	SL-1 reports.	09/26/2003	2
National Archives and Records Administration (NARA) - College Park	Aircraft nuclear Propulsion reports, a Rover/Tory fuel disposal report, and the 1959 report on the future role of AEC laboratories.	08/17/2010	4
National Archives and Records Administration (NARA) - Seattle	Incident reports, ETR, TAN, CFA, MTR, SPERT Health Physics reports, radiation exposure reports, shipment records, radioactive waste reports, radiological survey records, Safety Section reports, Burial Ground reports, and Industrial Hygiene reports.	12/18/2014	205
National Archives and Records Administration (NARA) - Seattle / SC&A	1954 and 1955 environmental records.	11/15/2006	2

Table A1-1: Data Capture Synopsis for Idaho National Lab			
Data Capture Information	General Description of Documents Captured	Date Completed	Uploaded To SRDB
National Institute for Occupational Safety and Health (NIOSH)	Internal dose assessment and bioassay manuals and reports, environmental transport reports, reports to Congress, the AEC history, interviews, worker outreach documents, radiological surveys, effluent releases, and plutonium bioassay and contamination reports.	12/31/2014	94
National Institute for Occupational Safety and Health (NIOSH) / SC&A	Highly Enriched Uranium Working Group reports, a recycled uranium report, an INL former worker medical surveillance program report, and a study on aerosols generated by metal cutting techniques.	10/20/2006	7
National Nuclear Security Administration (NNSA), Albuquerque Office	A 1996 external dosimetry report.	09/03/2008	1
National Technical Information Service (NTIS)	Spent fuel storage casks tests and analyses.	02/19/2010	2
New York State Archives	Waste disposal and 1952 periodic reports.	03/19/2012	2
Nevada Test Site	The Tory II-C fact sheet and a Nevada environmental impact statement.	01/12/2003	2
Nuclear Regulatory Commission Non-Public Holdings	Redacted radiation exposure reports and a blowdown rests report.	06/04/2012	3
Nuclear Regulatory Commission Public Document Room	Inspection reports, management of transuranic waste, material transfer reports, and the INEEL emergency plan and RCRA contingency plan.	12/17/2014	21
Oak Ridge Library for Dose Reconstruction	Design of an iodine removal unit from the ICPP waste gas stream, waste treatment reports, MTR-B project waste solutions, and Oak Ridge National Laboratory reports referencing INL.	05/10/2011	14
Oak Ridge National Laboratory (ORNL)	Eleventh DOE workshop on personnel neutron dosimetry, the transfer of U-233 to INL, request for an irradiation in the MTR, and ORNL periodic reports referencing INL.	03/20/2014	55
Ohio Department of Health	An Aircraft Nuclear Propulsion report, a 1953 Initial Engine Test report, and an environmental restoration report.	11/03/2008	3
ORAU Team	Technical basis documents, technical information bulletins, annual DOE radiation exposure reports, effluent monitoring, newspaper articles, counting systems calibrations, whole body counting reports, documented communications, instrumentation descriptions and manuals, and DOE adoption of 1990 ICRP neutron weighting factors.	11/25/2014	106
Rocky Flats Environmental Technology Site (RFETS)	An assessment of the flammability and explosion potential of defense transuranic waste.	05/17/2006	1
SAIC	Radiation exposure summaries.	09/02/2004	8
Sandia National Laboratory - NM	Radiation exposure requests and Sandia Engineering Reactor Health Physics logs.	01/17/2012	5
Santa Susana Field Laboratory	Organic Moderated Reactor Experiment reports.	08/10/2009	26
Savannah River Site (SRS)	Dosimetry visitor cards and SRS periodic reports referencing INL.	03/19/2012	35

Table A1-1: Data Capture Synopsis for Idaho National Lab			
Data Capture Information	General Description of Documents Captured	Date Completed	Uploaded To SRDB
S. Cohen & Associates (SC&A)	Environmental reports, SNAPTRAN reports, incident reports, the RWMC history, an SL-1 report, inventory and manufacturing statements, ICPP production reports, and a documented communication.	04/07/2011	101
SC&A / ANL-E	A report on planned processing of irradiated plutonium fuel assemblies, the production of transplutonium elements, and a description of ANL critical facilities.	06/24/2010	3
SC&A / INL	Environmental monitoring reports, incident reports, periodic facility reports, history of buried transuranic waste at INL, construction staff meeting notes, ICPP process reports, remedial investigation reports and work plans, SL-1 reports, ground water reports, radiochemistry reports, pollution control, effluent releases, Initial Engine Test reports, decontamination and decommissioning reports, material inventories, lab notebooks, Health Physics monthly reports, and source term quality control tasks.	06/24/2010	1,980
SC&A / INL / Seattle NARA	1956 monthly radioactive waste reports.	06/24/2010	1
SC&A / Internet - OpenNet	The first 50 years plutonium history.	10/28/2014	1
SC&A / Internet - DOE OSTI Information Bridge	The 1992 review of the Radiological Environmental Surveillance Program.	08/06/2010	1
SC&A / Internet - Google	A 1959 waste calcination off-gas study.	09/02/2014	1
SC&A / Internet - University of North Texas	Design and hazards summary report on the Boiling Reactor Experiment V (Borax V).	10/13/2014	1
SC&A / Pinellas Plant	A 1993 waste generation and minimization report.	06/24/2010	1
SC&A / West Valley Demonstration Project	Quality control of West Valley TLDs at DOE-ID, procedure for releasing exposure histories, procedures for the records interface with DOE-ID, special dose evaluations, and preparation of samples for shipment to INL.	05/06/2011	7
Senator John Heinz History Center	A history of Westinghouse in atomic power.	12/20/2007	1
Southern Illinois University, Edwardsville, IL	AEC construction cost differentials and the SC&A review of the Mallinckrodt Site Profile which mentions the similarity between the Mallinckrodt and INL external dosimeter.	10/18/2008	2
University of Iowa	A records listing and the DOE Environmental Site Profile for INL.	07/11/2003	2
University of Tennessee Library	The report of Plutonium Task Force 7 and an SL-1 report.	10/03/2011	2

Table A1-1: Data Capture Synopsis for Idaho National Lab			
Data Capture Information	General Description of Documents Captured	Date Completed	Uploaded To SRDB
Unknown	An SL-1 report, safety analyses and hazard summaries, reactor procedures, effluent releases, environmental reports, radiation exposure reports, in-vivo reports, internal dosimetry incident reports, external dosimetry technology, technical bases, procedure reports, skin contaminations, and conferences on the peaceful uses of atomic energy.	06/28/2010	233
Unknown / INL	Fluidized bed calcination of aluminum nitrate wastes, 1971 Health Services Laboratory report, and 1979 environmental monitoring data.	05/10/2012	3
Unknown / SC&A	Environmental reports, the EBR-1 meltdown, and the SPERT-1 destructive test report.	10/24/2003	42
Unknown / SC&A / INL	A 1959 Health and Safety Division report.	10/24/2003	1
Washington University Library	A lithium cooled reactor report.	04/23/2007	1
West Valley Demonstration Project	A 1981 investigation of a radiation exposure at the MTR Plug Storage Area.	08/02/2006	1
Wyeth Insurance	A 1951 newsletter report on American Cyanamid winning the ICPP operating contract.	02/29/2008	1
Y-12 / SC&A	A report on plutonium contamination on recycled material from INL.	07/28/2010	1
TOTAL			9,350

Table A1-2: Databases Searched for Idaho National Laboratory			
Database/Source	Keywords / Phrases	Hits	Selected
NOTE: Database search terms employed for each of the databases listed below are available in the Excel file Called "Idaho National Laboratory Rev 00, (83.13) 02-06-15"			
Defense Technical Information Center (DTIC) https://www.dtic.mil/	See Note above	OPEN	
DOE CEDR https://www.ornl.gov/cedr	See Note above	OPEN	

Table A1-2: Databases Searched for Idaho National Laboratory			
Database/Source	Keywords / Phrases	Hits	Selected
DOE Hanford DDRS http://www2.hanford.gov/declass/ COMPLETED 09/18/2012	See Note above	32	12
DOE Legacy Management Considered Sites http://www.lm.doe.gov/considered_Sites/ COMPLETED 12/29/2014	See Note above	2,795	4
DOE NNSA - Nevada Site Office www.nv.doe.gov/main/search.htm COMPLETED 09/19/2012	See Note above	0	0
DOE OpenNet http://www.osti.gov/opennet/advancedsearch.jsp COMPLETED 12/29/2014	See Note above	7,641	75
DOE OSTI Energy Citations http://www.osti.gov/energycitations/ COMPLETED 09/19/2012	See Note above	47,027	39
DOE OSTI Information Bridge http://www.osti.gov/bridge/advancedsearch.jsp COMPLETED 09/19/2012	See Note above	41,900	221
DOE OSTI SciTech Connect http://www.osti.gov/scitech COMPLETED 12/29/2014	See Note above	2,687,639	634
Energy Employees Claimant Assistance Project (EECAP) http://www.eecap.org	See Note above	OPEN	
Google http://www.google.com COMPLETED 09/22/2014	See Note above	146,556,657	757
HP Journal http://journals.lww.com/health-physics/pages/default.aspx	See Note above	OPEN	
Journal of Occupational and Environmental Health http://www.ijoh.com/index.php/ijoh	See Note above	OPEN	
National Academies Press http://www.nap.edu/ COMPLETED 12/29/2014	See Note above	56,359	7

Table A1-2: Databases Searched for Idaho National Laboratory

Database/Source	Keywords / Phrases	Hits	Selected
NEPIS http://nepis.epa.gov/ COMPLETED 12/29/2014	See Note above	40,154	31
NRC ADAMS Reading Room http://www.nrc.gov/reading-rm/adams/web-based.html COMPLETED 12/29/2014	See Note above	30,586	125
United States Army Corps of Engineers (USACE) http://www.usace.army.mil/ COMPLETED 12/29/2014	See Note above	10	0
U.S. Transuranium & Uranium Registries http://www.ustur.wsu.edu/ COMPLETED 12/29/2014	See Note above	930	1

Table A1-3: Interlibrary Loan Documents Requested for Idaho National Laboratory

Document Number	Document Title	Date Requested	Date Received
NA Ref ID: 32032	A Whole-Body Counter with Rotating Detectors from Health Physics Journal Vol. 16:709-717	03/20/2013	03/20/2013
NA Ref ID: 32031	A Portable Whole-Body Counter from Health Physics Journal Vol 13:141-148	03/20/2013	03/20/2013
IDO-14453 Ref ID: 139094	Technical Progress Report for April through June 1958: Idaho Chemical Processing Plant	11/11/2014	01/13/2015
IDO-14457 Ref ID: 139096	Technical Progress Report for July through September 1958: Idaho Chemical Processing Plant	11/11/2014	01/13/2015
IDO-14467 Ref ID: 139097	Technical Progress Report for October through December 1958: Idaho Chemical Processing Plant	11/11/2014	01/13/2015
IDO-14471 Ref ID: 139095	Technical Progress Report for January through March 1959: Idaho Chemical Processing Plant	11/11/2014	01/13/2015
IDO-14494 Ref ID: 139093	Technical Progress Report for April through June 1959: Idaho Chemical Processing Plant	11/11/2014	01/13/2015
IDO-14526 Ref ID: 139092	Idaho Chemical Processing Plant Technical Progress Report: Radioactive Waste Disposal Projects, October-December 1959	11/11/2014	01/13/2015

Table A1-3: Interlibrary Loan Documents Requested for Idaho National Laboratory

Document Number	Document Title	Date Requested	Date Received
IDO-14530 Ref ID: 139090	Idaho Chemical Processing Plant Technical Progress Report: Radioactive Waste Disposal Projects, January-March 1960	11/11/2014	01/13/2015
IDO-14514 Ref ID: 139091	Idaho Chemical Processing Plant Technical Progress Report, Radioactive Waste Disposal Projects, July-September 1959	11/11/2014	01/13/2015