

RI 9438

REPORT OF INVESTIGATIONS/1992

Effectiveness of Iron-Based Fuel Additives for Diesel Soot Control

By H. William Zeller and T. E. Westphal

UNITED STATES DEPARTMENT OF THE INTERIOR



BUREAU OF MINES

Report of Investigations 9438

Effectiveness of Iron-Based Fuel Additives for Diesel Soot Control

By H. William Zeller and T. E. Westphal

UNITED STATES DEPARTMENT OF THE INTERIOR
Manuel Lujan, Jr., Secretary

BUREAU OF MINES
T S Ary, Director

Library of Congress Cataloging in Publication Data:

Zeller, H. William.

Effectiveness of iron-based fuel additives for diesel soot control / by H. William Zeller and T.E. Westphal.

p. cm. — (Report of investigations; 9438)

Includes bibliographical references (p. 16).

1. Mine dusts. 2. Diesel fuels—Additives—Testing. 3. Ferrocene. I. Westphal, T. E. (Terry E.). II. Title. III. Series: Report of investigations (United States. Bureau of Mines); 9438.

TN23.U43 [TN312] 622 s—dc20 [622'.83] 92-13640 CIP

CONTENTS

	<i>Page</i>
Abstract	1
Introduction	2
Problem	2
Fuel additives	2
Background	2
Flame-type additives	2
Combustion catalysts	2
Objectives	3
Acknowledgments	3
Apparatus and procedures	3
Engine	3
Particulate measurement	3
Gas emissions measurement	3
Experimental approach	5
Test plan for ferrous picrate	5
Test plan for ferrocene	5
Baseline tests	5
Engine conditioning	6
Data analysis	6
Experimental results for ferrous picrate	6
Experimental results for ferrocene	7
Effects of ferrocene in engine's combustion chamber	7
Conditioning effects on exhaust properties	7
Research duty cycle	7
Steady-state engine modes	8
Discussion and interpretation of experimental results	12
Proposed mechanisms involving catalytic oxidation surfaces	12
Effect of sulfates on particulate	13
Research recommendations	15
Conclusions	16
References	16
Appendix A.—Fuel comparison	18
Appendix B.—Maintenance concentration effects on emissions	20
Appendix C.—Data analysis	21
Appendix D.—Engine and emissions data	22

ILLUSTRATIONS

1. Diesel engine testing facility	4
2. Air intake and dilution systems	4
3. Effect of ferrous picrate on DPM emissions at two concentrations of additive in fuel	7
4. Effect of ferrous picrate on CO emissions at two concentrations of additive in fuel	7
5. Effect of ferrocene conditioning on exhaust parameters for multimode duty cycle	8
6. Effect of ferrocene conditioning on CO emissions	9
7. Effect of ferrocene conditioning on NO _x emissions	9
8. Effect of ferrocene conditioning on CO ₂ emissions	9
9. Effect of ferrocene conditioning on O ₂ emissions	9
10. Effect of ferrocene conditioning on DPM percentage	10
11. Effect of ferrocene conditioning on DPM concentration	10
12. Effect of ferrocene conditioning on solid DPM emissions	10
13. Effect of ferrocene conditioning on volatile DPM emissions	10

ILLUSTRATIONS—Continued

	<i>Page</i>
14. Effect of conditioning time on ratio of extinction coefficient to DPM mass	11
15. Effect of ferrocene conditioning on gas-phase hydrocarbons emissions for steady-state loads at 2,300 r/min	11
16. Effect of ferrocene conditioning on gas-phase hydrocarbons emissions for steady-state loads at 1,600 r/min	11
17. Effect of fuel-air ratio on estimated sulfate fraction in DPM	13
18. Effect of fuel-air ratio on estimated sulfate fraction in volatile DPM	13
19. Effect of fuel-air ratio on estimated sulfate fraction in solid DPM	14
20. Effects of sulfates on ferrocene conditioning at various fuel-air ratios	14
21. Effect of barium and ferrocene on DPM	15
A-1. DPM emissions for two fuels	18
A-2. Gas-phase hydrocarbon emissions for two fuels	18
A-3. Volatile DPM emissions for two fuels	19
B-1. Effect of maintenance concentration of ferrocene on exhaust parameters	20
B-2. Effect of maintenance concentration of ferrocene on extinction coefficients	20
B-3. Effect of maintenance concentration of ferrocene on gas-phase hydrocarbons	20
C-1. Adjustment procedures for fuel-air variations	21

TABLES

1. Modified SAE J1003 emissions test	5
2. Research duty cycle modes	5
3. Conditioning cycle	6
4. Oxygen concentration differences between conditioned and unconditioned engine	12
A-1. Diesel fuel analysis	18
D-1. General test data	22
D-2. Engine load, sample time, and intake conditions	23
D-3. Engine conditions	24
D-4. Particulate parameters	25
D-5. Gas-phase emissions	26

UNIT OF MEASURE ABBREVIATIONS USED IN THIS REPORT

atm	atmosphere, standard	lb/h	pound per hour
bhp	brake horsepower	lb/hp-h	pound per horsepower-hour
cfm	cubic foot per minute	mg	milligram
cm	centimeter	mg/m ³	milligram per cubic meter
°F	degree Fahrenheit	min	minute
ft	foot	mm Hg	millimeter of mercury
ft-lb	foot pound	oz	ounce
gal	gallon	pct	percent
h	hour	ppm	part per million
h/d	hour per day	r/min	revolution per minute
hp	horsepower	s	second
in	inch	wt pct	weight percent
L	liter		

EFFECTIVENESS OF IRON-BASED FUEL ADDITIVES FOR DIESEL SOOT CONTROL

By H. William Zeller¹ and T. E. Westphal²

ABSTRACT

The U.S. Bureau of Mines evaluated the effects of two iron-based fuel additives on diesel particulate matter (DPM) emissions. The 5.6-L, six-cylinder test engine is typical of engines used in underground mines. One additive, ferrous picrate, did not measurably affect exhaust emissions. This report is mainly about a ferrocene-based additive that reduced DPM between 4 and 45 pct, depending on engine operating conditions. The report concludes that the DPM reductions were caused by the catalytic oxidation properties of a ferric oxide coating that developed inside the engine's combustion chamber. The ferric oxide coating also decreased gas-phase hydrocarbons and O₂, but it increased CO₂ and NO_x. The increase in NO_x of about 12 pct, is considered the only adverse effect of the ferrocene-based fuel additive. The results suggest that the effectiveness of ferrocene was partially offset by increased sulfates because of the high-sulfur fuel used. Recommendations for continuing fuel additive research are presented.

¹Physical scientist.

²Mechanical engineer (now with Ford Motor Company, Dearborn, MI).
Twin Cities Research Center, U.S. Bureau of Mines, Minneapolis, MN.

INTRODUCTION

PROBLEM

Diesel-powered equipment is widely used in underground mining because of its high productivity and flexibility compared with electric-powered equipment. Unfortunately, diesel engines emit particulates consisting of carbonaceous agglomerates, adsorbed organic compounds, and other substances such as sulfates and metals. Although diesel particulate matter (DPM) levels are not specifically regulated in underground mines, DPM adds to the general dust level.

To help mine operators comply with dust standards and to address concerns about potential occupational health problems (22)³ arising from exposure to DPM emissions, the U.S. Bureau of Mines is conducting research to develop improved DPM control methods. Much of the research has been on the evaluation of the diesel particulate filter (3), but to provide the mining industry with alternatives the Bureau is also evaluating fuel additives.

FUEL ADDITIVES

Background

The work presented here is a continuation of fuel-additive research initially reported by the Bureau in 1987 (31). These earlier investigations were on a postflame, barium-based additive, and they confirmed claims that additives can reduce DPM emissions (31-33). Although the barium additive was not effective at light engine loads, the DPM reductions measured were sufficient to encourage further additive testing.

The selection of additional additives involved consideration of the following requirements: to broaden the scope of the research by testing other additive categories, such as flame-type; to evaluate only additives for which emissions reductions have been documented; and to include only additives expected to have negligible adverse health effects when emitted in the engine exhaust. Certain iron-based compounds met all three of these requirements.

A particular attraction of iron-based additives is the lack of any documented adverse health effects caused by iron compounds in the exhaust. For example, Klarman (14) did not identify any health-related problems attributable to iron-based fuel additives.

Iron-based fuel additives have been shown to reduce DPM emissions from diesel engines (18-19). Related research on turbines (17, 27) and laboratory simulations

using various flame geometries (4, 15) showed that iron-based additives, such as ferrocene and iron naphthenate, can reduce carbon emissions.

Flame-Type Additives

Fuel atomizers are one category of flame-type additives. Both Parsons (23) and Walker (29) reported that fuel-atomizing additives containing ferrous picrate reduced smoke from diesel engines. The commercial product chosen for evaluation by the Bureau was FE-6 fuel additive,⁴ which is available from Ferrous Corporation, P.O. Box 1764, Bellevue, WA, 98009. (There are at least two other sources for fuel additives containing ferrous picrate: Fuel Technology Pty Ltd., P.O. Box 100, Darra, Queensland 4076, Australia, and FPC Enterprises, P.O. Box 156, Evans City, PA, 16033.)

Combustion Catalysts

A ferrocene-based fuel additive was selected for evaluation because of claims that it enhanced combustion through the formation of a catalytic ferric oxide (Fe_2O_3 or hematite) coating on the engine's combustion surfaces. This additive, Diesel Maxi-miser, is available commercially from Econalytic Systems, Inc., 4845 Pearl East Circle, Suite 300, Boulder, CO, 80301-2474.

The catalytic properties of ferric oxide are well known. For example, one commercial method for producing sulfuric acid used catalytic ferric oxide to oxidize SO_2 to SO_3 , although platinum is probably the preferred catalytic agent now (8). Miyamoto proposed that some metal-based additives may inhibit soot formation at the beginning of combustion and concluded that many metals including iron ". . . have dramatic catalytic effects not only to improve reaction rate but also to reduce activation energy in soot oxidation . . ." (18-19).

Murray (21) measured gaseous emissions reductions for an engine coated with an oxidation catalyst. Sapienza (24) and Gaffney (9) plated the combustion surfaces of a diesel engine with platinum. This procedure produced an initial DPM reduction of 40 pct, but after 8 h of continuous operation the DPM emissions were identical with those measured before the application of the platinum. The authors believed that the platinum was lost because of poor adhesion to the walls, which were not prepared and had surface impurities, including carbon.

³Italic numbers in parentheses refer to items in the list of references preceding the appendixes at the end of this report.

⁴Reference to specific products does not imply endorsement by the U.S. Bureau of Mines.

OBJECTIVES

The main objective of these investigations is to find the potential of fuel additives to reduce DPM when used in indirect injection engines representative of the types used in underground mines. This objective has been accomplished.

A second objective is to determine how to use the additives most effectively. Because ferrous picrate, at two different concentrations in the fuel, had no measurable effect on exhaust emissions, the tests were terminated. Ferrocene was effective at the manufacturer's

recommended concentration levels, but the work was terminated prematurely because of equipment problems.

A third objective is to identify undesirable effects caused by the additives such as reduced engine performance, reduced engine service life, and increases in toxic exhaust emissions. This objective has been partially completed for ferrocene because changes in some toxic emissions were measured.

The main purpose of this study is to justify the conclusions that ferrocene-treated fuel produced a catalytic ferric oxide coating on portions of the test engine's combustion surfaces, that this coating enhanced combustion, and that it reduced DPM.

ACKNOWLEDGMENTS

The accomplishment of the long-duration tests discussed in this report required considerable cooperation among the individuals who operate the diesel engine test facility. The authors acknowledge the following people

for their efforts to complete the program within the constraint of available time: C. F. Anderson, A. M. Benning, C. G. Cordova, T. L. Hillman, G. R. Vandenbos, and M. J. Vogel.

APPARATUS AND PROCEDURES

The equipment and procedures used in this investigation (fig. 1) are described only briefly here. More detailed descriptions of the engine controls, dilution tunnel, DPM collection, and gas emissions measurements are in other Bureau reports (7, 31).

ENGINE

A naturally aspirated, indirect injection, four stroke Deutz F6L 912W diesel engine was used. The engine is rated for 83 hp at 2,300 r/min. An eddy-current dynamometer supplied the loads to the test engine. Speed and load were controlled within ± 1 r/min and ± 1 ft-lb, respectively. A mass metering system, with an accuracy of ± 0.5 pct, measured fuel consumption. The air supply system (fig. 2) maintained the engine's intake manifold at conditions equivalent to Society of Automotive Engineers' (SAE's) standards (76° F, 1 atm) for power measurements (26). DPM and other emission concentrations presented in this report are adjusted to these SAE standard conditions.

PARTICULATE MEASUREMENT

The dilution system (fig. 2) provided a representative sample of the exhaust for DPM samples. The diesel particulates were collected on 8- by 10-in fluorocarbon-coated, glass-fiber filters. Temperature and pressure across the sample orifice were measured and used to calculate dilution ratios. The dilution was also checked from

measurements of nitrogen oxides (NO_x) in the raw and the diluted exhaust. An in-line diesel exhaust smokemeter measured smoke opacity.

GAS EMISSIONS MEASUREMENT

Five gaseous exhaust components were measured (fig. 1). The sample for gas-phase measurements was extracted from the raw exhaust at a point near the dilution tunnel sampling point and was transported to the gas emissions measuring instruments through a 25-ft line heated to 400° F. CO_2 and CO were measured with nondispersive, infrared analyzers. O_2 was measured with an instrument with a polarographic sensor. NO_x were measured with chemiluminescence analyzers. Measurements of specific nitrogen oxides were not obtained.

Gas-phase hydrocarbons (GPHC) were measured with a flame ionization detector (FID). FID responds only to those hydrocarbons that manage to penetrate the heated sampling line and the particulate filter just ahead of the instrument. Hydrocarbons with boiling points less than 400° F are presumed to penetrate to the FID, but low-volatile components, such as oils with boiling points greater than 600° F, are not believed to penetrate to the FID at all. Substances with boiling points between 400° and 600° F, such as many polycyclic aromatic hydrocarbons and paraffin fuel components, may only be partially measured.

Preliminary experiments (unpublished) showed that FID response accounts for less than 35 pct of diesel fuel sample

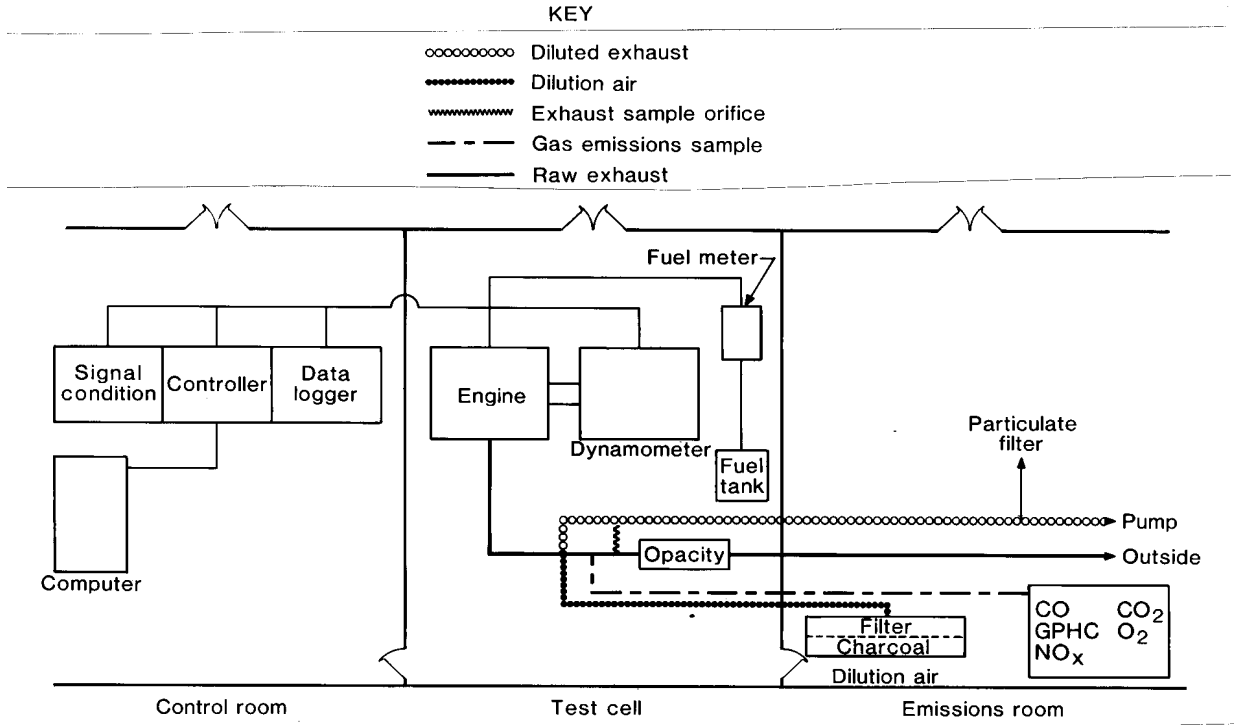

Figure 1.—Diesel engine testing facility.

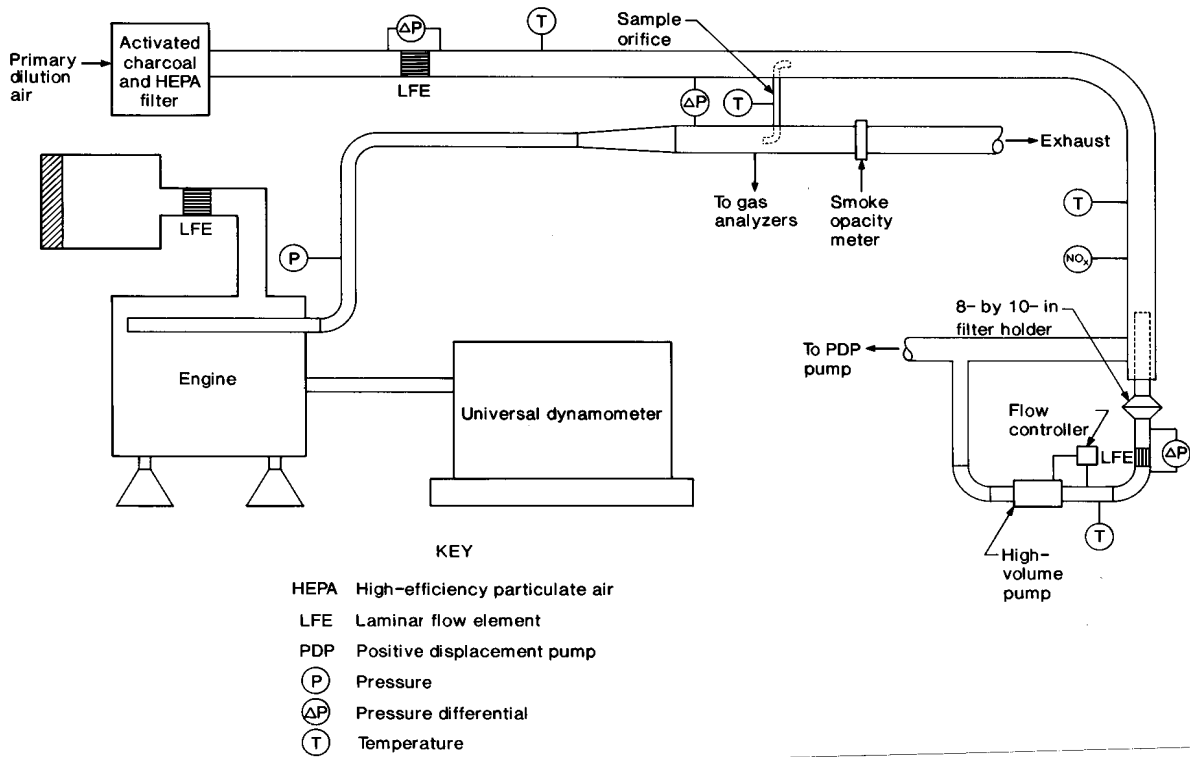

Figure 2.—Air intake and dilution systems.

injected at the sample line intake. Also, the response of the instrument may depend on the molecular weight or

carbon number of compounds (6). Methane was used in these experiments to calibrate the FID.

EXPERIMENTAL APPROACH

TEST PLAN FOR FERROUS PICRATE

The test plan for ferrous picrate called for initial screening tests at steady-state engine conditions to measure effects of the additive on DPM emissions for a wide range of fuel-air ratios at different engine speeds and loads. The test conditions included engine operation at idle and three additional speeds—peak torque speed of about 1,600 r/min, 1,830 r/min (80 pct of rated speed), and at the rated speed of 2,300 r/min. Engine loads included 50, 75, 90, and 100 pct of full torque at the selected speeds.

The plan also called for the screening tests to be conducted at the recommended concentration in diesel fuel of 1 part additive to 3,000 parts fuel, or 0.033 wt pct. If the preliminary screening tests showed that the additive had any potential for reducing DPM, more extensive testing was planned.

When no effects on exhaust emissions were measured, 1 set of additional tests was conducted using an additive concentration 10 times that recommended, or 1 part additive to 300 parts fuel. When no emissions effects were observed, the tests on ferrous picrate were terminated.

TEST PLAN FOR FERROCENE

This additive requires a period of engine "conditioning" to develop the catalytic coating inside the engine (16). The conditioning process requires engine operation with ferrocene-treated fuel at a concentration about four times greater than the "maintenance" concentration recommended for maintaining the coating in normal use. Because of the engine conditioning required, the test plan for ferrocene was much more extensive than that for ferrous picrate. The plan called for the following phases: baseline measurements to establish initial engine emissions levels, engine conditioning to develop the ferric oxide coating, and repetition of the baseline tests to measure the effects of engine conditioning with ferrocene.

Baseline Tests

This phase established the baseline emissions for the unconditioned engine. Each set of baseline measurements consisted of a modified SAE J1003 (26, pp. 25.25-25.26) emissions series (table 1) and the research duty cycle (RDC) (table 2). The results of the SAE J1349 power

curve test (26, pp. 24.09-24.10) were used to define the actual torque loadings used.

Table 1.—Modified SAE J1003 emissions test

(Time for each mode was 20 min)

Mode ¹	Speed, r/min	Load, pct	Air intake density, pct ²
1	750	0	0.97
2	1,600	2	.97
3	1,600	25	.97
4	1,600	50	.97
5	1,600	75	.97
6	1,600	100	.97
7	750	0	.97
8	2,300	100	.97
9	2,300	75	.97
10	2,300	50	.97
11	2,300	25	.97
12	2,300	2	.97
13	750	0	.97
14	1,600	100	.87

¹Modes 1 through 13 comprise the SAE J1003, 13-mode sequence, and modes 1 through 14 comprise the modified SAE J1003 test sequence.

²Percent of density at SAE standard conditions.

Table 2.—Research duty cycle modes

Applied time, s	Speed, ¹ pct	Load, pct
30	100	50
30	100	100
30	25	25
30	100	50
30	100	100
30	(²)	0
30	(³)	100
60	(²)	0
30	(³)	100
30	100	100
30	25	25
60	(²)	100
60	(²)	0

¹Full speed is rated at 2,300 r/min.

²Engine idle.

³Engine at peak torque speed, about 1,600 r/min for Deutz engine.

The first two baseline sets were conducted using fuel without ferrocene. These tests are identified by the numerical suffixes 001 and 002 in appendix D. The third baseline set was with fuel treated with the maintenance concentration of 1 part additive to 1,280 parts fuel. These data have the numerical suffix 101 in appendix D. The purpose was to measure the effect, if any, of this low concentration on engine performance and exhaust emissions before the additive conditioning process began.

Engine Conditioning

The ferric oxide coating on the engine's combustion surfaces was formed in this phase by using the ferrocene-based additive in the fuel at the conditioning concentration of 1 part additive to 320 parts fuel (20 oz of additive in 50 gal of fuel).

Using the special conditioning cycle (table 3), the engine was operated 8 to 10 h/d. The engine intake was pressurized to about 50 in of water above local atmospheric pressure to minimize DPM emissions and to shorten the time necessary to condition the engine.

Table 3.—Conditioning cycle

Speed, r/min	Load, pct	Time, min
2,070	80	30
2,070	90	30
2,070	100	30
2,300	100	30
2,300	90	30
2,300	80	30

During the conditioning cycle, CO and opacity were continuously monitored to detect any effects of the conditioning process. Periodically the engine was run with the maintenance concentration of the additive to check on the emissions changes. The procedure was the same as that in the baseline phase except that only about half the test modes were checked. These were modes 1, 2, 6, 8, 10, 14, and the RDC. Because of the premature termination of the conditioning process, these data are the basis for evaluating the effects of the conditioning process and are labeled with the suffixes 102, 103, 104, and 105 in appendix D.

EXPERIMENTAL RESULTS FOR FERROUS PICRATE

The ferrous picrate concentrations used were 0.033 and 0.33 wt pct of the commercial product in the fuel. Based on information from the distributor, the concentration of the active ingredient, ferrous picrate, in the fuel at the recommended concentration (0.033 wt pct) is estimated to be about 0.5 ppm.

Data Analysis

The intent was to repeat the tests conducted during the initial baselining phase and compare the emission measurements to evaluate additive effects. In the original plan, data from all 14 steady-state conditions (table 1) and the RDC were to be analyzed for exhaust emissions changes for comparison with the initial baseline measurements.

Unfortunately, engine conditioning was terminated after 244 h because of dynamometer failure. Consequently, the analysis was restricted to the six steady-state modes and the RDC, for which data were obtained during the conditioning phase. These seven modes are considered adequate and representative because they include light-, medium-, and full-load tests; idle, peak-torque, and full-rated speed tests; two intake conditions; and the RDC, which is a combination of many engine operating conditions.

The possibility that a fuel change at 90 h was responsible for the effects observed on exhaust properties was eliminated by the following procedures. First, the exhaust data were examined for any abrupt or step-like changes in levels occurring at the time of the fuel change. None were found. Second, both fuels were run in another engine, a Caterpillar 3304. Analyses of the exhaust properties for the Caterpillar engine showed no detectable differences between the two fuels (appendix A). Third, fuel properties were also examined for differences. The data (appendix A) show differences considered too small to produce the exhaust property effects observed. Furthermore, the differences are considered to be within the error range of the property test procedures. Because all the fuel came from the same supplier, the similarity between the two fuel lots was anticipated.

Another potential problem was that all the data obtained during the conditioning process were from fuel containing the maintenance concentration of the ferrocene additive. However, no effect of the low maintenance concentration was detected in the baseline data involving tests with and without ferrocene (appendix B). Because no noticeable differences were attributable to additive in the fuel, all the baseline data are considered equivalent. In the analyses that follow, the unconditioned-engine data (suffixes 001, 002, and 101 in appendix D) are usually combined to provide an average baseline value against which the conditioned-engine data are compared.

Ferrous picrate had no effect on DPM emissions from the Deutz engine (fig. 3). Furthermore, the use of the additive had no effect on CO, CO₂, O₂, hydrocarbons, and NO_x. The measurements plotted in figure 4 for CO are representative of those obtained for all the gaseous emissions. Ferrous picrate is said to burn out engine

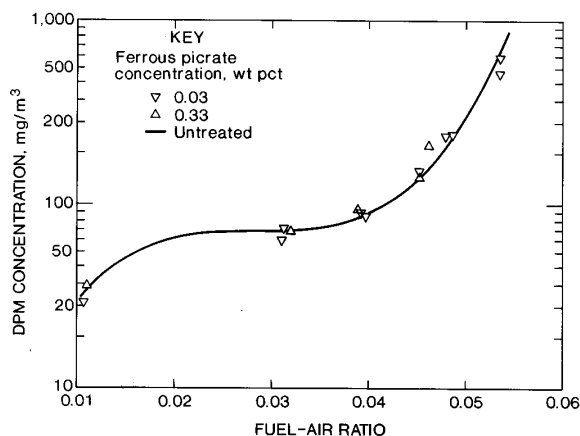

Figure 3.—Effect of ferrous picrate on DPM emissions at two concentrations of additive in fuel.

deposits (29). Claims of hydrocarbon and CO reduction are probably based on data obtained after substantial periods of engine operation with treated fuel and could be the result of reduced engine deposits. The results obtained in this study do not confirm or contradict claims

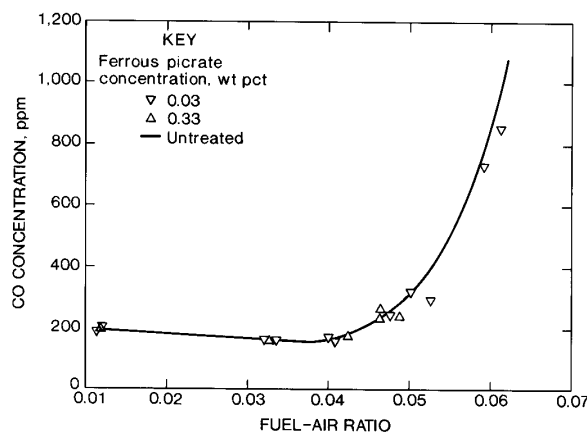

Figure 4.—Effect of ferrous picrate on CO emissions at two concentrations of additive in fuel.

for reducing engine deposits. The engine was not run long enough to verify that property of the additive.

Based on these results, it is concluded that any changes in fuel atomization caused by ferrous picrate have no effect on particulate and gaseous emissions from a well-maintained engine in good operating condition.

EXPERIMENTAL RESULTS FOR FERROCENE

EFFECTS OF FERROCENE IN ENGINE'S COMBUSTION CHAMBER

Before beginning the engine conditioning process with ferrocene, one cylinder was disassembled and inspected for carbon and residual deposits from previous tests of a barium-based fuel additive. The combustion chamber surfaces were coated with a thin carbon layer that appeared hard and durable. No evidence of barium compounds, such as those described by Golothan (10), was observed.

Periodic examination of the glow plugs throughout the conditioning phase revealed a steady accumulation of a red deposit. Based on the experience of others, mainly the chemical analysis by Klarman (14), the red deposits were assumed to be ferric oxide.

It was anticipated that ferric oxide coatings were also forming in the engine's prechamber. When the conditioning phase was terminated, however, neither carbon nor other coatings were observed on the prechamber surfaces, which appeared smooth, reflective, and metallic. Only a fraction of the prechamber could be examined, however, because the only borescope available was too large to be inserted through either the fuel injector or glow plug openings. Consequently, the condition of most of the prechamber surface is not known.

In the main combustion chamber, portions of the surface were covered with the red oxide coating that had displaced the carbon found in the initial inspection. The ferric oxide deposits on both the piston crown and the cylinder head were heaviest near the prechamber passage.

It was anticipated at the time of this inspection that conditioning and testing would be resumed, so disturbance of the coatings was restricted to minimal scratching of the ferric oxide. Much of the oxide coating on the metal was sufficiently hardened to resist the attempts to remove it by scraping.

CONDITIONING EFFECTS ON EXHAUST PROPERTIES

Research Duty Cycle

Engine conditioning effects on exhaust properties are illustrated in figure 5 for the RDC. Three measurements of each plotted parameter were obtained before beginning the conditioning process. The averages of these three runs are the engine baseline levels from which the percent changes were calculated. The CO measurements after 101 h are not available because of instrumentation problems.

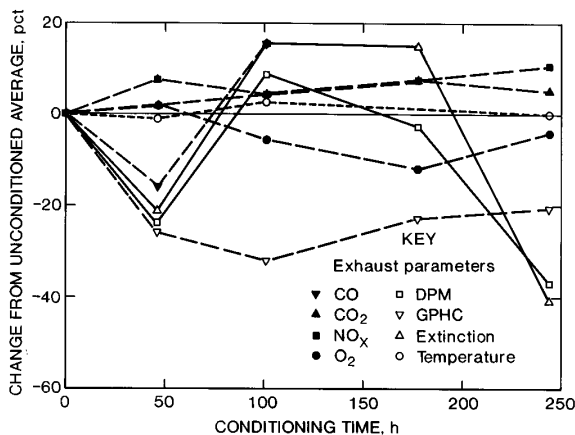

Figure 5.—Effect of ferrocene conditioning on exhaust parameters for multimode duty cycle. (GPHC = gas-phase hydrocarbons).

When conditioning was terminated after 244 h, all the exhaust emissions were altered. The main objective of this research program is to reduce DPM emissions from diesel engines, so the 37-pct reduction after 244 h is considered a significant result. Because the RDC is a composite of operating conditions intended to simulate load-haul-dump operation, this reduction represents the DPM control level that is achievable in actual mining conditions.

A conspicuous result is the variability of the DPM changes with conditioning time. The fact that the fuel-air ratios at 101 and 178 h were 3 pct higher than the unconditioned, baseline measurements may have contributed to the variability. The possible influence of increasing sulfate, caused by the conditioning process, is discussed in a following section. The correlation of both the smoke extinction coefficient and CO emissions with DPM agrees with earlier Bureau results (31, 33).

The increase in CO₂ and NO_x levels plus the reduction in O₂, GPHC, and DPM levels are evidence of enhanced combustion, consistent with the hypothesis that the conditioning process produced a coating having catalytic oxidation properties.

NO_x increases are not desirable because of adverse health effects. The NO_x increase of about 12 pct represents expected increases in mines. Similar NO_x increases were measured by the Bureau for a barium-based fuel additive (32).

Steady-State Engine Modes

The experimental results for steady-state engine conditions are organized into two groups—gaseous emissions and particulate exhaust emissions. Engine conditioning

effects on gaseous emissions are presented in detail here for two reasons. First, with only one exception, all the results are consistent with the oxidation catalyst hypothesis. Second, the changes observed for two toxic gases, CO and NO_x, are documented so that informed judgments about health effects can be made.

The plots (figs. 6-14) of exhaust emission changes are similar to those in figure 5, except that the changes are the differences between conditioned values and values predicted by regression fits to unconditioned-engine data. The purpose is to compensate for small fuel-air ratio variations between unconditioned and conditioned tests. The procedures are described in appendix C. The GPHC data (figs. 15-16) were not analyzed by this procedure because of unsatisfactory regression fits to the unconditioned-engine data, especially for the measurements at 1,600 r/min.

Gaseous Exhaust Emissions

GPHC concentration measurements are plotted against fuel-air ratios in figures 15 and 16. Unconditioned-engine data are plotted for all 14 test modes, but conditioned-engine measurements are available only for modes 1, 2, 6, 8, 10, and 14.

The measurements at full-rated speed (2,300 r/min) (fig. 15) show GPHC reductions for all conditioned-engine data. Therefore, the full-speed data support the idea of enhanced fuel combustion resulting from the conditioning process. At 1,600 r/min (fig. 16), however, many measurements show GPHC increases. Two reasons are offered to explain the discrepancy: (1) the general unreliability of the FID instrument discussed previously and (2) the possible influence of prior engine operating conditions. Tests were always conducted in the order of the mode number (table 1). Engine operating conditions prior to beginning the test sequence were variable and were observed to affect the results for mode 1 (idle) and possibly for mode 2. However, at the full-speed conditions, modes 8 through 12, engine and exhaust temperatures were more consistent because of the consistency established by the conduct of the seven prior modes.

Except for mode 2, CO levels (fig. 6) were reduced after 244 h of engine conditioning. The increase measured for mode 2 was about 30 ppm, which was 7 pct greater than the average of levels for unconditioned-engine data. The increase at 101 h for mode 14 is considered a measurement error because of the obvious inconsistency with the plots for all the other modes and inconsistency with DPM reductions that normally correlate closely, especially at this high fuel-air ratio.

The incidence of both increased and decreased concentrations after 244 h of conditioning agrees with Bureau results for barium (31-32). Because CO is an intermediate

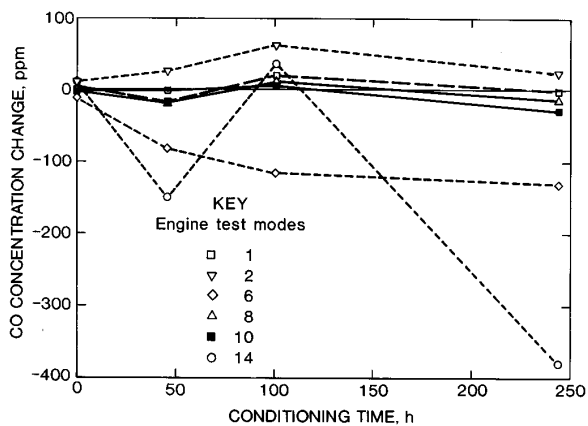

Figure 6.—Effect of ferrocene conditioning on CO emissions.

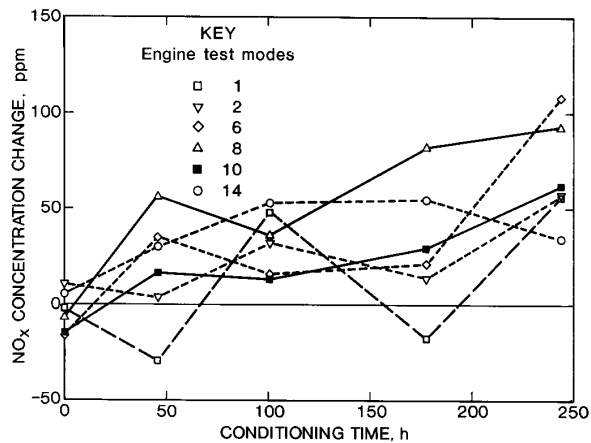

Figure 7.—Effect of ferrocene conditioning on NO_x emissions.

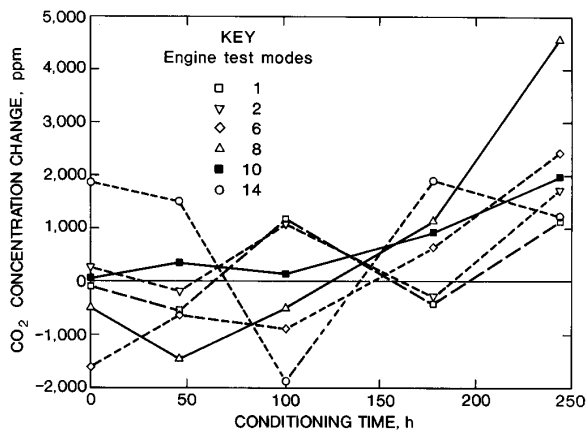

Figure 8.—Effect of ferrocene conditioning on CO₂ emissions.

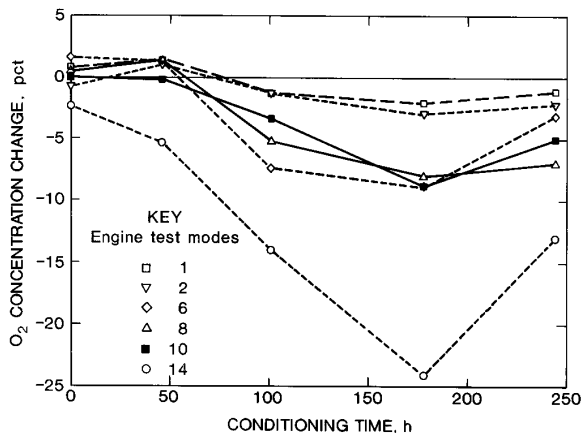

Figure 9.—Effect of ferrocene conditioning on O₂ emissions.

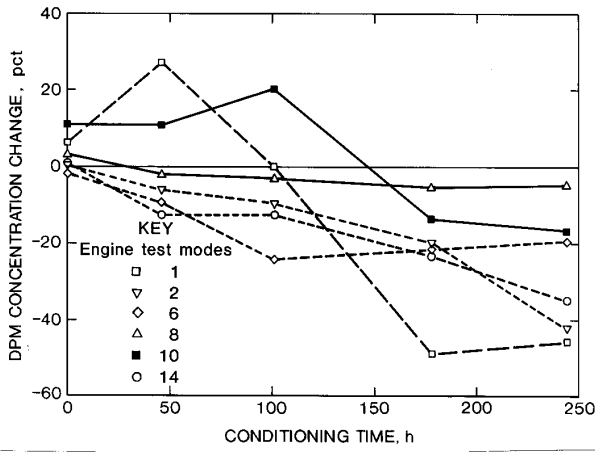

Figure 10.—Effect of ferrocene conditioning on DPM percentage.

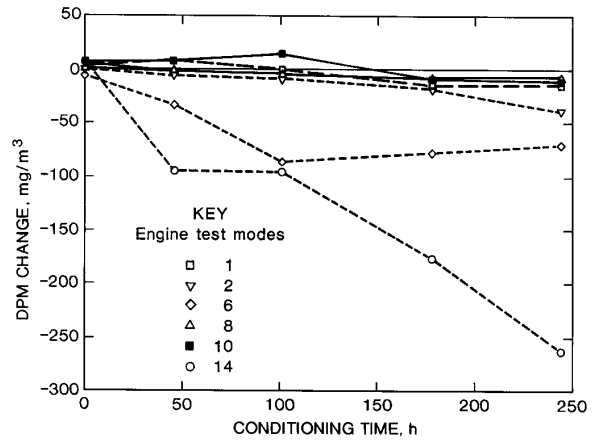

Figure 11.—Effect of ferrocene conditioning on DPM concentration.

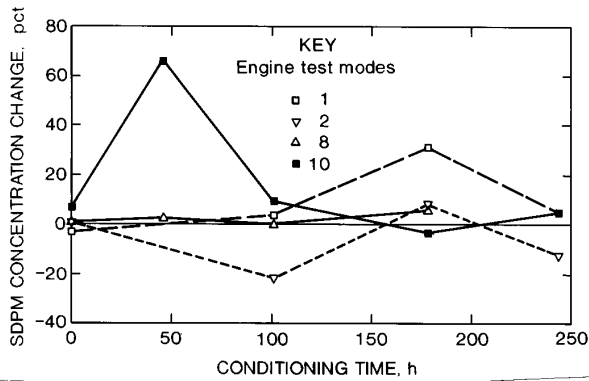

Figure 12.—Effect of ferrocene conditioning on solid DPM (SDPM) emissions.

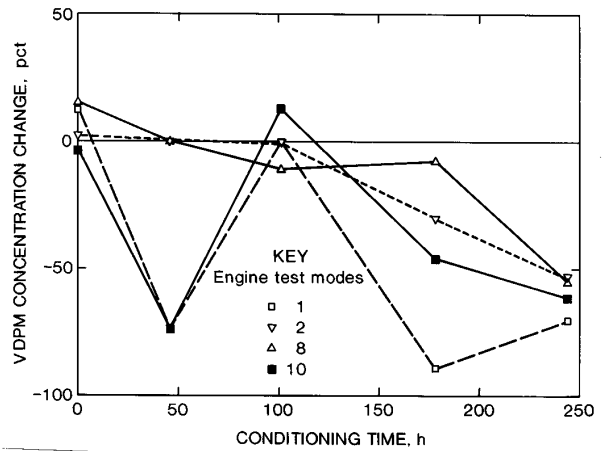

Figure 13.—Effect of ferrocene conditioning on volatile DPM (VDPM) emissions.

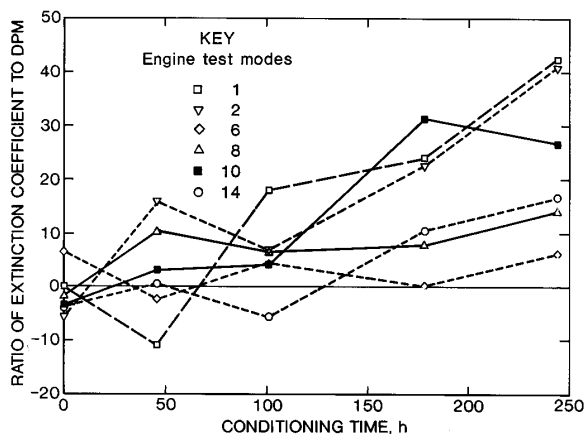

Figure 14.—Effect of conditioning time on ratio of extinction coefficient to DPM mass.

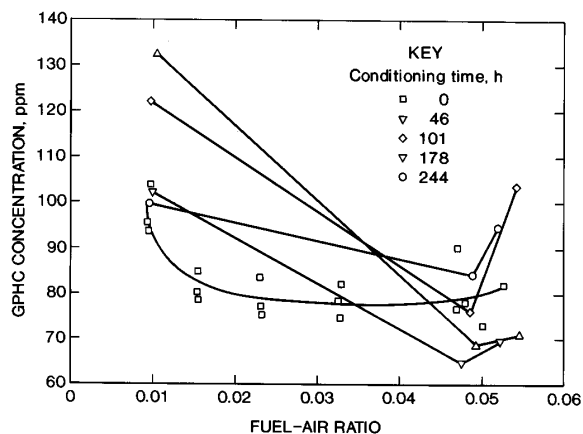

Figure 16.—Effect of ferrocene conditioning on gas-phase hydrocarbons (GPHC) emissions for steady-state loads at 1,600 r/min.

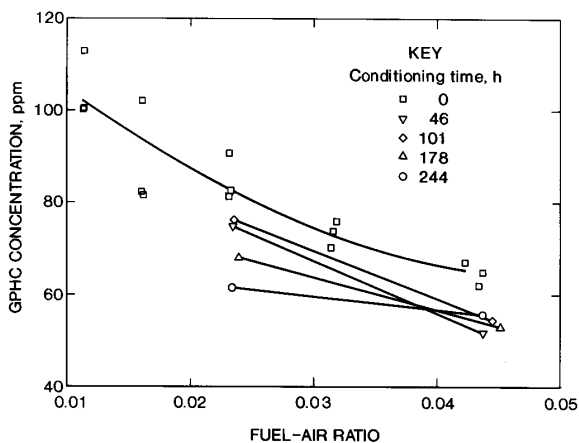

Figure 15.—Effect of ferrocene conditioning on gas-phase hydrocarbons (GPHC) emissions for steady-state loads at 2,300 r/min.

combustion product, CO levels can increase because of improved fuel combustion, but also can decrease because of complete combustion to CO₂.

The increased NO_x levels for all engine modes after 244 h (fig. 7) confirm the hypothesis that ferrocene-treated fuel enhances catalytic oxidation. After only 46 h of conditioning, NO_x levels increased for modes 6, 8, 10, and 14, consistent with the increase determined for the RDC at 46 h (fig. 5). The variability at mode 1 and, to some extent, for mode 2 is attributable to both instrument error and the influence of prior engine operating conditions, as discussed previously for GPHC variability at those modes.

CO₂ levels (fig. 8) increased with engine-conditioning time, consistent with the enhanced oxidation hypothesis. The maximum increase was more than 4,000 ppm for mode 8. The increases for the remaining modes ranged between 800 and 2,200 ppm.

Expressed as percent changes, the largest increase after 244 h was 8 pct for mode 2. The increases for modes 1, 8, and 10 were between 4 and 5 pct and were equivalent to the 5-pct increase measured for the RDC. The CO₂ concentration for mode 14 was about 120,000 ppm, so the changes observed for this mode were less than 2 pct. Because of this small percentage change, even small errors in the measurement of fuel rate, airflow, and CO₂ concentration can account for the mode-14 variability observed during the conditioning process.

The percent changes in O₂ levels for the steady-state modes are shown in figure 9. The O₂ levels for all modes continuously decreased after 46 h to minimum values (maximum change) at 178 h and then either increased or remained approximately level at 244 h. These data are consistent with the O₂ trend for the RDC, for which the percent changes are roughly equivalent to those of mode 10 and also showed a maximum change at 178 h.

The actual O₂ differences, expressed in parts per million, during the conditioning process are summarized in table 4. The results for the RDC are included for comparison. After 101 h all the values were negative, indicating that more O₂ is consumed because of the conditioning process. The largest changes measured were 11,000 and 12,000 ppm extra O₂ consumption for mode 10 and the RDC at 178 h.

Table 4.—Oxygen concentration differences between conditioned and unconditioned engine by test mode, parts per million

(Concentration change equals conditioned minus unconditioned)

Conditioning time, h	1	2	6	8	10	14	RDC
0	1,300	-1,400	1,000	300	-40	-1,200	-500
46	2,500	1,700	800	1,000	-400	-2,400	2,900
101	-2,400	-2,400	-4,100	-3,500	-4,500	-5,100	-4,800
178	-3,800	-5,200	-4,700	-5,200	-11,000	-7,800	-12,000
244	-2,100	-3,900	-1,800	-4,800	-6,600	-5,600	-6,700

RDC Research duty cycle.

Mass balances for the unconditioned-engine test data ($t = 0$ h in table 4) accounted for all the O_2 , within ± 1 pct, into and out of the engine. The exhaust components included in the mass balance were O_2 , CO_2 , NO_x , H_2O , and SO_2 . In the case of conditioned-engine data, however, the O_2 mass balances did not account for all the O_2 into the engine. The largest imbalance was for the RDC at 178 h, for which 9 pct of the intake O_2 could not be accounted for in the exhaust. Instrument response time may have contributed to the discrepancy because simple averages were used for the 8-min transient test cycle (RDC). The next largest discrepancy was for mode 14 at 178 h where 6 pct of the O_2 into the engine was not accounted for. There is no explanation for this result.

Particulate

Three types of particulate are discussed in this section. The total weight gain of the filter deposits is termed DPM. The material remaining on the filter after treatment for 24 h in a 400° F vacuum oven is called the solid diesel particulate matter (SDPM). The fraction removed by the oven treatment is the volatile diesel particulate matter (VDPM) and is intended to represent an estimate of organic extractables or the soluble organic fraction (SOF).

DISCUSSION AND INTERPRETATION OF EXPERIMENTAL RESULTS

Experimental observations, noted in previous sections, indicate that engine conditioning with ferrocene-treated fuel produced a red coating of ferric oxide on combustion surfaces and caused exhaust emissions changes for both transient (RDC) and steady-state engine operating conditions. The discussions in this section are intended to provide additional support for the oxidation catalyst hypothesis by proposing mechanisms for the observed emissions changes and by estimating the expected effects of sulfate emissions.

Because the vacuum oven process also removes most sulfates (11), the SOF is overestimated.

The relative or percent DPM changes (fig. 10) show that DPM emissions were already reduced at 46 h for modes 2, 6, 8, and 14. After 178 h DPM emissions were reduced for all modes. At 244 h the reductions were between 35 and 45 pct for modes 1, 2, and 14. These maximum reductions for steady-state conditions are equivalent to the reduction of 37 pct for the RDC at 244 h (fig. 5).

Comparison of the DPM concentration changes (fig. 11) with those for CO (fig. 6) show close agreement, especially for modes 6 and 14. This agreement implies that both emissions are affected similarly by ferrocene. This result is also consistent with a comparable relationship observed for the RDC (fig. 5).

SDPM and VDPM data (fig. 12) for both unconditioned and conditioned tests are available only for modes 1, 2, 8, and 10. Although not determined, measurement error is the most likely explanation for the large increase recorded for mode 10 at 46 h.

After 244 h the SDPM was not substantially different from the range of values measured for the unconditioned engine at $t = 0$ h. These data confirm that only the magnitude of the SDPM was unchanged. Conclusions about composition changes—the relative levels of carbon and sulfates—cannot be made.

If the magnitude of the SDPM was unaffected by the conditioning process, then the DPM reductions were probably caused by reduced VDPM. This inference is verified in figure 13, which shows VDPM reductions after 178 h for all test modes and substantial reductions, more than 50 pct, after 244 h.

The ratios of extinction coefficients to DPM concentrations (fig. 14) increase with engine conditioning time. Earlier Bureau results showed that extinction response is mainly a function of SDPM (31, 33). Therefore, the increasing ratios in figure 14 are consistent with the composition changes caused by VDPM (SOF) reductions (31, 33).

PROPOSED MECHANISMS INVOLVING CATALYTIC OXIDATION SURFACES

According to Kamimoto, one source of DPM is wall quenching of combustion flames (12). He concluded that "flame impingement has contradictory effects on diesel combustion. It enhances mixing and promotes utilization of high density air (oxygen) near the wall, but at the same time causes flame quenching which is one of the main origins of soot emission."

Because wall quenching increases DPM emissions, it follows that changes in wall properties, such as the formation of a catalytically active coating, may have major effects on emissions. For example, catalytically enhanced combustion at the chamber wall may raise wall temperatures sufficiently to mitigate flame-quenching effects and reduce unburned hydrocarbons in the exhaust.

There is also at least one mechanism to account for the reduction of carbon formed in the gas phase. Ambs (1) showed that up to 40 pct of exhaust particulates spend some time on combustion chamber surfaces. Specifically, Ambs' model describes how carbon particles are deposited thermophoretically on the walls and then are reentrained into the exhaust stream.

Shchukin (25) has shown that under some conditions, such as SO_2 oxidation to SO_3 , thermophoretic forces caused by the high wall temperatures, because of catalytically active surfaces, may repel particles from the walls. The particle size of soot carbon, which remains suspended in the gas phase, is smaller and more easily oxidized than the large agglomerates entrained from wall deposits.

Cooper (5) describes mechanisms that can enhance oxidation of this gas-phase carbon through the formation of active oxidizing species such as NO_2 . The catalytic ferric oxide enriches the concentration of NO_2 in a zone near the wall. Soot arriving in this zone will adsorb NO_2 , which oxidizes C to CO, which may be further oxidized to CO_2 . This mechanism is consistent with the NO_x increases depicted in figure 7.

EFFECT OF SULFATES ON PARTICULATE

Although the contribution of sulfates to DPM was not measured in this study, it can be estimated. There is general agreement that 1 to 3 pct of the fuel sulfur is converted to sulfates in the exhaust from uncatalyzed diesel engines (2,13). Truex proposed that this conversion takes place on the surface of exhaust carbon in diesel engines (28).

Data by Baranescu (2) indicate that the conversion rate depends on engine load (temperature) and is the basis for assuming a SO_2 to SO_3 conversion function that increases linearly from 1 pct at fuel-air ratios of 0.01 to 3 pct at a fuel-air ratio of 0.06.

Halsall (11) observed that about 70 pct of the sulfates formed are removed by vacuum oven sublimation, leaving 30 pct of the sulfates on the filter.

Based on the fuel sulfur level of 0.4 pct, the assumed linear conversion function, and on Halsall's measurements, estimated sulfate contributions to DPM, VDPM, and SDPM are shown for the unconditioned engine in figures 17 through 19. Even though only 1 to 3 pct of the fuel sulfur is converted to sulfates in the exhaust emissions,

the sulfate contribution to DPM can be substantial, especially at fuel-air ratios between 0.02 and 0.04 (fig. 17).

The high sulfate levels in this range of fuel-air ratios are caused by the manner in which soot carbon and sulfates change with fuel-air ratio. Sulfates increase more rapidly than carbon at low fuel-air ratios. Therefore, the ratio of sulfates to carbon increases rapidly. At fuel-air ratios greater than about 0.04, carbon levels increase much more rapidly than sulfate levels; therefore, the significance of the sulfates is reduced at high fuel-air ratios. The net result is that modes 8 (20 pct sulfate) and 10 (12 pct sulfate) are most affected and mode 2 (2 pct sulfate), which has a low fuel-air ratio of 0.01, is the least affected.

At high fuel-air ratios, a surprising result is that sulfates can potentially account for most of the VDPM (fig. 18) as measured by the vacuum oven method. On the other hand, the estimates (fig. 19) show that sulfates

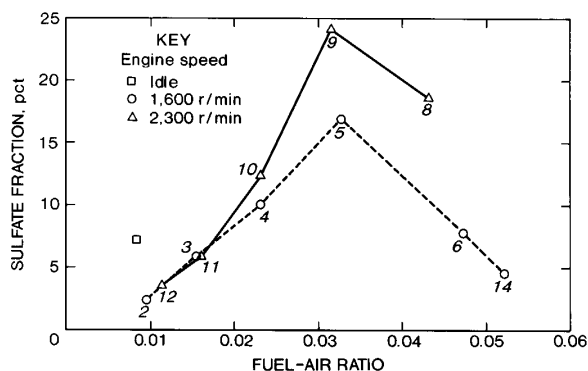

Figure 17.—Effect of fuel-air ratio on estimated sulfate fraction in DPM. Data labels are test modes.

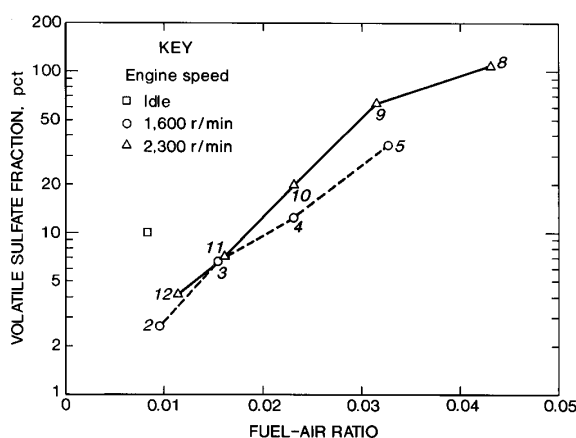

Figure 18.—Effect of fuel-air ratio on estimated sulfate fraction in volatile DPM (VDPM). Data labels are test modes.

contribute less than 8 pct to the total SDPM for non-catalyzed engines. The fact that SDPM remained unchanged (fig. 12) at 244 h suggests that some unknown factor may have been involved to ensure that nonvolatile sulfate increases were balanced by nearly equal carbon and SOF reductions.

For catalyzed systems the sulfate levels are expected to be greater (30). The development of a catalytic oxide coating and changing sulfate levels can account for the DPM variability with conditioning time that was observed for the RDC. The reduced GPHC at 46 h (fig. 5) could account for the DPM reduction also observed at that point in the conditioning process. As conditioning proceeded, the catalytic reactions of the developing ferric oxide deposits caused increased sulfate levels, accounting for the increased DPM at 101 h. Finally, at 244 h, the ferric oxide coating was sufficiently developed to significantly reduce both carbon and GPHC. The order of catalytic oxidation effects suggested here is consistent with the temperatures at which GPHC, SO_2 , and carbon oxidize—hydrocarbons oxidize at the lowest temperature and carbon at the highest.

As noted earlier, the results shown for VDPM and SDPM (figs. 18-19) suggest that all the DPM reductions observed were the result of VDPM (SOF) reductions, a conclusion that may be true for engine modes at low fuel-air ratios where SOF levels are high—up to 50 pct (32). On the other hand, the large DPM reductions, of about 20 and 30 pct for modes 6 and 14 cannot be the result of VDPM reductions, because the VDPM levels for these two modes are less than 5 pct for the unconditioned engine (32). Furthermore, estimates in figure 18 suggest that sulfates may contribute significantly to VDPM at modes having high fuel-air ratios. Therefore, the inference is that the observed DPM reductions must be the result of reduced carbon levels.

In figure 20 two sets of data are combined: the sulfate contributions to DPM from figure 17 and the DPM reductions at 244 h from figure 10. The striking feature is that the two curves are almost mirror images. The comparison strongly suggests that the observed DPM changes were greatly influenced by sulfates and tends to confirm

the inferences in the preceding discussions. Note especially that the sulfate levels (fig. 20) are for the unconditioned engine. Conversion rates increase with the use of oxidation catalytic converters (30). In other words, the sulfate interference for the conditioned engine is probably underestimated in figure 20.

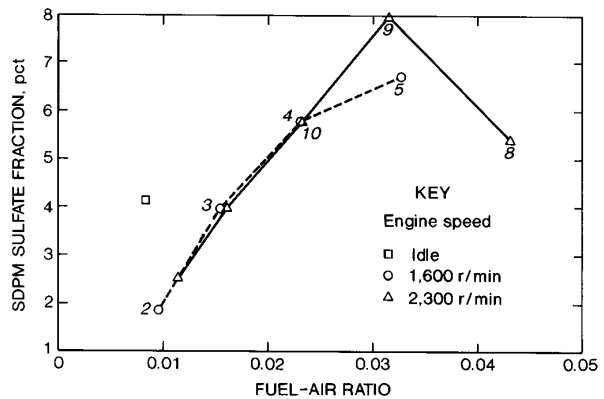

Figure 19.—Effect of fuel-air ratio on estimated sulfate fraction in solid DPM (SDPM). Data labels are test modes.

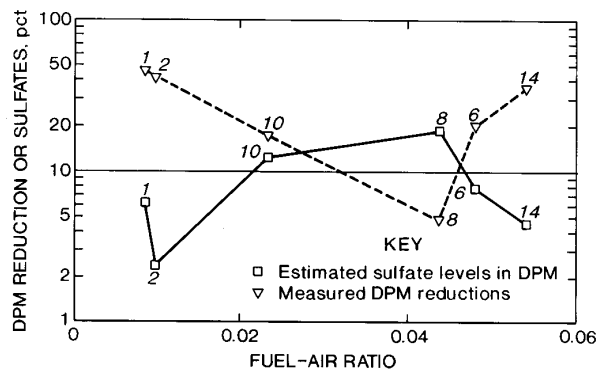

Figure 20.—Effects of sulfates on ferrocene conditioning at various fuel-air ratios. Data labels are test modes.

RESEARCH RECOMMENDATIONS

The Bureau has tested three fuel additives—ferrous picrate, barium, and ferrocene—to determine their potential for reducing DPM. Ferrous picrate was ineffective, so only the Bureau's earlier results for a barium-based fuel additive and the ferrocene results are compared in figure 21. These data show that barium is more effective than ferrocene at fuel-air ratios greater than about 0.025, which corresponds to a 50- to 60-pct load at full-rated speed of 2,300 r/min. For example, barium reduced DPM by 75 pct at full load, compared with ferrocene, which reduced DPM by 43 pct. At light loads, on the other hand, ferrocene reduced DPM by 35 to 45 pct, while barium was not effective.

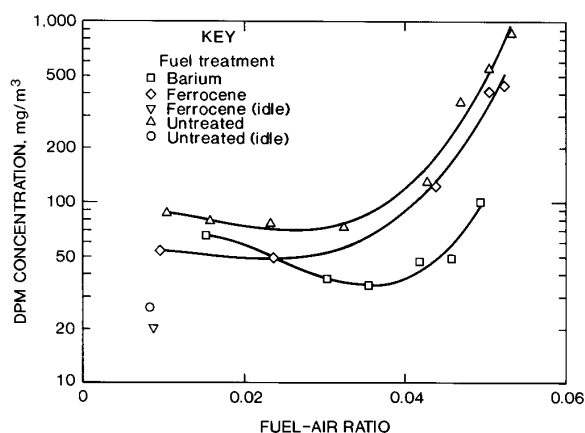

Figure 21.—Effect of barium and ferrocene on DPM. Data are averages.

There is a possibility that the two additives could be used simultaneously in the same engine. If they are compatible, the DPM reductions for the combination may be greater than either used alone over the full range of engine operation. Therefore, tests for compatibility and simultaneous usage could be pursued.

All the Bureau's tests on additives have been with high-sulfur fuels (about 0.4 pct fuel sulfur). Therefore, an area of recommended research is testing both ferrocene and barium with low-sulfur fuels. Besides alleviating the problem of increased sulfates caused by the oxidizing properties of the additives, low-sulfur fuel alone may reduce DPM by 20 to 25 pct (30).

The water scrubber, used on diesel-powered equipment in coal mines, may remove DPM more effectively when ferrocene is used. One study (20) found that DPM concentrations decreased when catalytic converters were used in the exhaust ahead of water scrubbers, because the converter removed some of the volatiles and made the soot more wettable. This result is consistent with the fact that the main effect of ferrocene in the work reported here was to reduce VDPM. Therefore, it is recommended that ferrocene be tested with a scrubber-fitted engine to confirm this effect.

The results reported here are for only one duty cycle. It is recommended that the tests be repeated to determine the maximum emissions reduction possible for other duty cycles and a range of operating conditions, both steady state and transient. The test plan should include provision for determining the optimum engine conditioning procedures such as ferrocene concentration and engine duty cycle. The optimum additive concentration to maintain engine conditioning should also be determined.

CONCLUSIONS

Laboratory tests of two iron-based fuel additives were conducted to evaluate their potential for reducing DPM from engines of the type used in mines and to identify adverse effects. One additive, ferrous picrate, did not affect engine exhaust properties and specifically did not measurably affect DPM.

The ferrocene-treated fuel produced red deposits in the engine's main combustion chamber. It is concluded that the red coating is ferric oxide and that it acts as an oxidation catalyst. The concentrations of all measured exhaust emissions—CO, CO₂, O₂, GPHC, NO_x, and DPM—were affected by conditioning the engine with ferrocene-treated fuel.

DPM concentrations were reduced for all tested engine conditions compared with DPM concentrations before

the addition of ferrocene to the fuel. The DPM reductions ranged between 4 and 45 pct for six steady-state engine operating conditions. The DPM reduction for an 8-min transient cycle was 37 pct.

At low and moderate fuel-air ratios, measurements show that DPM changes were mainly the result of reduced levels of VDPM. At high load conditions, however, an analysis of the results showed that carbon levels must have been substantially reduced also.

The major adverse effect of the ferrocene additive was increased NO_x levels at all tested conditions. The 12-pct NO_x increase, observed for the RDC, represents increases that ferrocene-treated fuel might cause in actual mining conditions.

REFERENCES

1. Ambs, J. Thermophoretic Deposition of Particles Inside the Combustion Chamber of a Diesel Engine. M.S. Thesis, Univ. MN, Minneapolis, MN, 1989, 98 pp.
2. Baranescu, R. A. Influence of Fuel Sulfur on Diesel Particulate Emissions. (Pres. at Future Transp. Tech. Conf. and Exp., San Francisco, CA, Aug. 8-11, 1988). SAE 881174, 1988, 11 pp.
3. Baumgard, K. J., and K. L. Bickel. Development and Effectiveness of Ceramic Diesel Particle Filters. Paper in Diesels in Underground Mines. BuMines IC 9141, 1987, pp. 94-102.
4. Bonczyk, P. A. Investigation of Fuel Additive Effects on Sooting Flames (Final report, contract F49620-83-C-0113). Air Force Office of Scientific Research 86-0851, 1986, 128 pp.; NTIS AD-A172 522.
5. Cooper, B. J., and J. E. Thoss. Role of NO in Diesel Particulate Emissions Control. SAE 890404, 1989, pp. 171-183; reprinted from SP-775, Developments in Diesel Particulate Control Systems.
6. Cuthbertson, R. D., P. R. Shore, L. Sundstrom, and P. O. Heden. Direct Analysis of Diesel Particulate-Bound Hydrocarbons by Gas Chromatography with Solid Sample Injection. SAE 870626, 1987, 12 pp.
7. Draper, W. M., J. Phillips, and H. W. Zeller. Impact of a Barium Fuel Additive on the Mutagenicity and Polycyclic Aromatic Hydrocarbon Content of Diesel Exhaust Particulate Emissions. SAE 881651, 1988, 19 pp.
8. Ehret, W. F. Smith's College Chemistry. D. Appleton-Century, 6th ed., 1946, pp. 351-352.
9. Gaffney, J., R. Sapienza, T. Butcher, C. Krishna, W. Marlow, and T. O'Hare. Soot Reduction in Diesel Engines: A Chemical Approach. Combust. Sci. and Technol., v. 24, 1980, pp. 89-92.
10. Golothan, D. W. Diesel Engine Exhaust Smoke: The Influence of Fuel Properties and the Effects of Using Barium-Containing Fuel Additive (Proc. Automotive Eng. Congr., Detroit, MI, Jan. 9-13, 1967). SAE 670092, 1967, 23 pp.
11. Halsall, R., and M. L. McMillan. An Improved Method for Determining the Hydrocarbon Fraction of Diesel Particulates by Vacuum Oven Sublimation. (Pres. at Int. Fuels and Lubr. Meet. and Exp., Toronto, Ontario, Nov. 2-5, 1987). SAE 872136, 1987, 16 pp.
12. Kamimoto, T., and M. Yagita. Particulate Formation and Flame Structure in Diesel Engines. (Pres. at Int. Congr. and Exp., Detroit, MI, Feb. 27-Mar. 3, 1989). SAE 890436, 1989, 9 pp.
13. Kanne, D. D., and R. Y. Iwamoto. A Novel Approach to the Control of Heavy-Duty Diesel Particulate Emissions. SAE 880634, 1988, 28 pp.
14. Klarman, A. F. Evaluation of the Extended Use of Ferrocene for Test Cell Smoke Abatement; Engine and Environmental Test Results. Interim rep., NAVAIR AIRTASK NO. 5365360-0522-66231000. 1977, 123 pp; NTIS AD-A047 659.
15. Korsakova, I. S., S. V. Akimov, E. A. Nikitina, and A. I. Malkova. Laboratory Method for Investigation of Smoke Suppressant Additives for Middle Distillate Fuels. Chem. and Technol. Fuels and Oils, v. 17, No. 7-8, Mar. 1982, pp. 426-428.
16. Kracklauer, J. J. Conditioning Diesel Engines. U.S. Pat. 4,389,220, June 21, 1983.
17. Maiko, L. P., E. P. Seregin, M. O. Lerner, L. A. Aleksandrova, V. I. Petrov, and V. T. Bugai. Improvement of Fuel Combustion Process in Gas Turbine Engines by the Use of Additives. Chem. and Technol. Fuels and Oils (Engl. Transl.), v. 13, No. 3-4, Mar.-Apr. 1977, pp. 253-256.
18. Miyamoto, N., Z. Hou, and H. Ogawa. Catalytic Effects of Metallic Fuel Additives on Oxidation Characteristics of Trapped Diesel Soot. SAE 881224, 1988, 7 pp.
19. Miyamoto, N., Z. Hou, H. Ogawa, and T. Murayama. Characteristics of Diesel Soot Suppressions With Soluble Fuel Additives. SAE 871612, 1987, 7 pp.
20. Mogan, J. P., and E. D. Dainty. Emission Control Performance of Diesel Exhaust Treatment Devices. Paper in Heavy-Duty Diesel Emission Control: A Review of Technology, ed. by E. W. Mitchell. Can. Inst. of Min. and Metall., Montreal, Quebec, CIM Spec. v. 36, 1986, pp. 135-142.
21. Murray, R. G. Performance and Emission Characteristics of a Semi-Adiabatic Engine. ASME Tech. Pap. No. 80-DGP-44, 1980, 12 pp.
22. National Institute for Occupational Safety and Health (Dep. Health and Human Services). Carcinogenic Effects of Exposure to Diesel Exhaust. Current Intelligence Bull. 50, DHHS (NIOSH) Publ. No. 88-116, Aug. 1988.
23. Parsons, J. B., and G. J. Germane. The Effects of an Iron-Based Fuel Catalyst Upon Diesel Fleet Operation. SAE SP-548, Aug. 1983, pp. 51-61.

24. Sapienza, R. S., T. Butcher, C. Krishna, and J. Gaffney. Soot Reduction in Diesel Engines by Catalytic Effects. Paper in Symposium on the Chemistry of Engine Combustion Deposits (Atlanta, GA, Mar. 29-Apr. 3, 1980). ACS, 1980, 10 pp.
25. Shchukin, E. R., and A. N. Kabanov. Characteristic Features of the Thermodiffusiophoretic Motion of Aerosol Particles in the Vicinity of a Catalytically Active Surface. *J. Aerosol Sci.*, v. 21, No. 3, 1990, pp. 409-414.
26. Society of Automotive Engineers (Warrendale, PA). SAE Handbook: Engines, Fuels, Lubricants, Emissions, and Noise. V. 3, 1982.
27. Thornburg, D. W. An Investigation of Engine and Test Cell Operating Conditions on the Effectiveness of Smoke Suppressant Fuel Additives. M.S. Thesis, Naval Postgraduate Sch., Monterey, CA, 1981, 102 pp.
28. Truex, T. J., W. R. Pierson, and D. E. McKee. Sulfate in Diesel Exhaust. *Environ. Sci. and Technol.*, v. 14, No. 9, 1980, pp. 1118-1121.
29. Walker, B. Improving Diesel Fuel Quality, Combustion, and Reducing Exhaust Emissions in Engines. *Aust. Min.*, June 1989, pp. 62-64.
30. Weaver, C. S., C. Miller, W. A. Johnson, and T. S. Higgins. Reducing the Sulfur and Aromatic Content of Diesel Fuel: Costs, Benefits, and Effectiveness for Emissions Control. SAE 860622, 1986, 16 pp.
31. Zeller, H. W. Effects of Barium-Based Additive on Diesel Exhaust Particulate. BuMines RI 9090, 1987, 40 pp.
32. _____. Fuel Additive and Engine Operation Effects on Diesel Soot Emissions. BuMines IC 9238, 1990, 17 pp.
33. _____. Measurement of the Effects of a Fuel Additive on Diesel Soot Emissions. Paper in Diesels in Underground Mines. BuMines IC 9141, 1987, pp. 79-93.

APPENDIX A.—FUEL COMPARISON

A fuel change was required after about 90 h of engine conditioning. Because the tests were terminated earlier than planned, the effects of the fuel change were evaluated by comparing the fuel property analyses and by comparing the exhaust emissions from both fuels. Because of conflicts with other programs requiring use of the test facility, these check tests were conducted on a Caterpillar 3304 engine.

The fuel analyses are in table A-1. The fuel used during the test period through the initial 90 h is designated Fuel A. The fuel used after the change is designated Fuel B.

Table A-1.—Diesel fuel analysis

	Refiner ¹		Laboratory ²	
	Fuel A	Fuel B	Fuel A	Fuel B
Aromatics pct. .	42	39	38	41
Sulfur pct. .	0.35	0.44	0.36	0.39
Cetane index	41	42	42	42
API gravity	32	31	33	31
Flash point °F. .	140	163	130	160
Distillation, 90 pct . . °F. .	593	614	600	617

¹Analysis conducted by local refiner.

²Analysis conducted by independent laboratory.

Fuel B appears to contain slightly more sulfur than Fuel A. Higher sulfur levels are expected to increase DPM emissions but, the DPM comparison (fig. A-1)

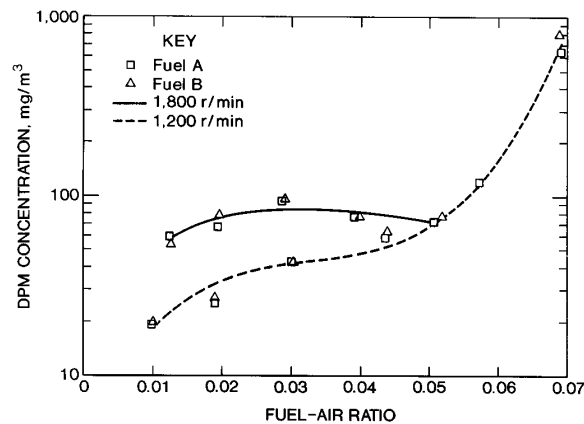

Figure A-1.—DPM emissions for two fuels.

shows no apparent change. A simple explanation is that the 0.44-pct measurement by the local refiner is too high. The actual difference in sulfur levels between the two fuels may be the 0.03 pct measured by the independent laboratory. This difference may be too small to have any detectable effect on DPM emissions.

A striking characteristic of figure A-1 is the large increase in DPM emissions for full-speed operation compared with operation at 1,200 r/min. This increase was the result of greater quantities of volatiles on the filter because of increased levels of GPHC at 1,800 r/min as verified by the plot of GPHC (fig. A-2).

This conclusion is also verified by the VDPM plots (fig. A-3), which show that the volatile fraction on the filters is much higher for 1,800-r/min operation when similar load modes are compared, such as mode 6 with mode 8 and mode 5 with mode 9. The point is that VDPM reductions were attributed to ferrocene conditioning of the engine. The results (figs. A-2 and A-3) confirm that these changes were not caused by the fuel change.

The flash point and distillation data in table A-1 indicate that fuel A is slightly more volatile than fuel B. The data in figures A-2 and A-3 show that this small volatility difference had no effect on either GPHC or VDPM emissions.

Finally, it should be noted that all the other exhaust emissions were examined for differences attributable to fuel. None were found.

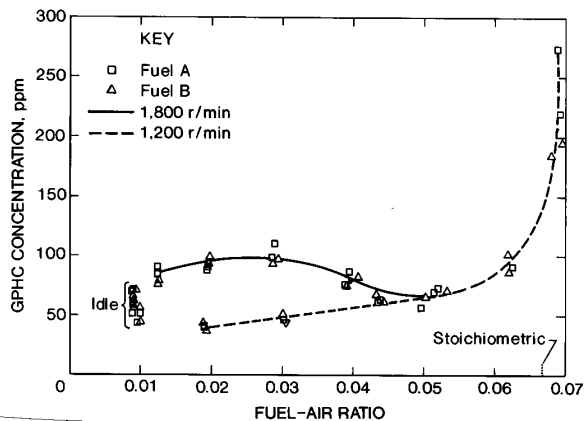

Figure A-2.—Gas-phase hydrocarbon (GPHC) emissions for two fuels.

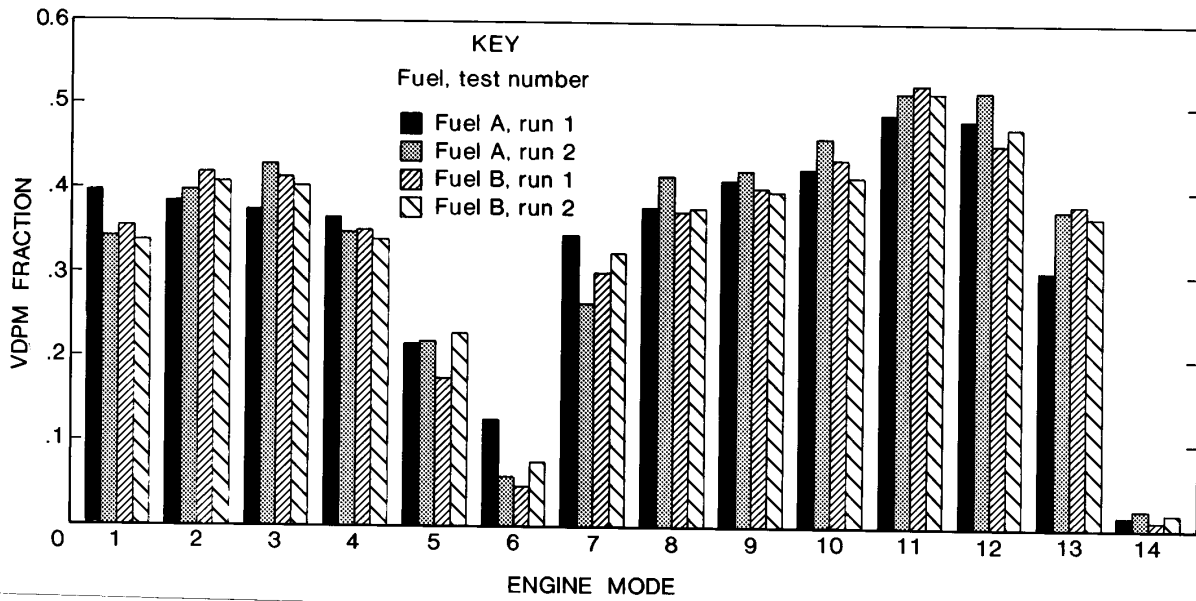

Figure A-3.—Volatile DPM (VDPM) emissions for two fuels.

APPENDIX B.—MAINTENANCE CONCENTRATION EFFECTS ON EMISSIONS

Two sets of baseline tests were conducted for all 15 test conditions (modified SAE J1003 and the RDC) using untreated fuel; these tests are designated as MAS001 and MAS002 in appendix D. The baseline tests were immediately followed by one set of tests, designated as MAS101, with the ferrocene-based additive at the maintenance concentration of 1 part additive to 1,280 parts fuel.

The percent change (fig. B-1) for exhaust properties is based on differences between the maintenance concentration values and the average of the two baseline measurements. Ten exhaust properties are plotted in figure B-1. Eight of the parameters for the maintenance concentration set differed by less than 2 pct from those for untreated fuel. Two of the parameters, extinction and GPHC, differed by more than about 5 pct from the untreated-fuel levels.

Many of the small changes in figure B-1 are opposite to the trends observed during the conditioning process and suggest that the differences are due mostly to data scatter. For example, O₂, GPHC, and DPM levels increase in figure B-1 while they decreased (for full-speed conditions only for GPHC) during the conditioning process. CO₂ and NO_x levels decrease here but both increased throughout conditioning. CO levels were inconclusive during conditioning.

The extinction data plotted in figure B-2 show that most of the variability (fig. B-1) is attributable to fuel-air ratio effects at the mode-14 values over 0.05. The main reason for the decrease of 9 pct is that the maintenance-concentration test was conducted at a reduced fuel-air ratio for mode 14 compared with the untreated-fuel ratios.

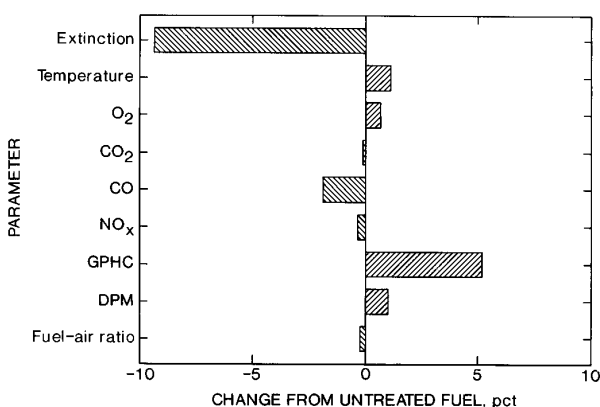

Figure B-1.—Effect of maintenance concentration of ferrocene on exhaust parameters. (GPHC = gas-phase hydrocarbons).

Note that the maintenance and untreated values agree well for all fuel-air ratios less than 0.05.

The plot of GPHC data (fig. B-3) shows that the increase of about 5 pct noted in figure B-1 is within the range of data scatter observed.

Because 8 out of 10 exhaust parameters exhibit almost no effects attributable to maintenance levels of additive and because the extinction changes observed are attributable to fuel-air ratio variations, it is concluded that the additive at the maintenance level had no measurable effect on engine performance and on emissions.

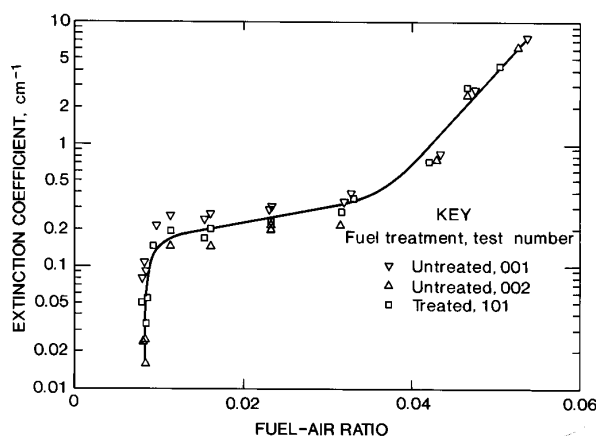

Figure B-2.—Effect of maintenance concentration of ferrocene on extinction coefficients.

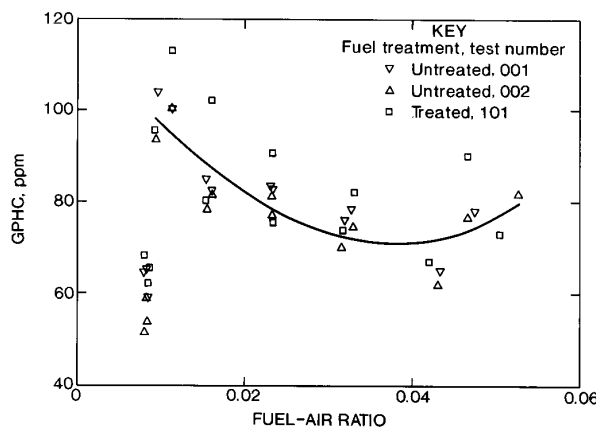

Figure B-3.—Effect of maintenance concentration of ferrocene on gas-phase hydrocarbons (GPHC).

APPENDIX C.—DATA ANALYSIS

Figure C-1 shows all the O_2 concentrations for mode 6, including the three baseline measurements (labeled "0") obtained prior to the conditioning process and the four measurements (labeled 46, 101, 178, and 244) obtained during the conditioning of the engine with ferrocene-treated fuel. The plot shows that after 46 h of conditioning O_2 emissions were similar to those observed for the unconditioned engine. For the remainder of the conditioning time O_2 emissions were clearly less than baseline levels.

Also shown in figure C-1 are two lines. The horizontal line is the average of the unconditioned engine measurements of O_2 concentration for mode 6. The second line is a regression fit of O_2 concentrations on fuel-air ratio for all the steady-state test modes conducted prior to the conditioning process. For O_2 , the fit is linear with a correlation coefficient of 0.997 over the entire fuel-air range from below 0.01 to over 0.05.

The best estimate of ferrocene treatment effects is considered to be the comparison of conditioned-engine data with the linear regression line (fig. C-1). For mode 6, the most significant effect of comparing the data with the regression line is to reduce the O_2 concentration changes attributed to the additive, because the differences between the values for 101, 178, and 244 h and the fuel-air trend line are smaller than they would be if calculated from the average line.

Note that the baseline or unconditioned-engine data are treated and plotted the same as the conditioned-engine

values. The only difference is that there are usually three measurements available for the unconditioned engine at each test mode instead of just the one value available for conditioned data at each combination of time and mode. Therefore, at $t = 0$ h the points plotted are averages of the differences between the three baseline values and the trend line established by regression analysis of all the untreated-engine data. These averages are usually different from zero and are a measure of data variability or scatter.

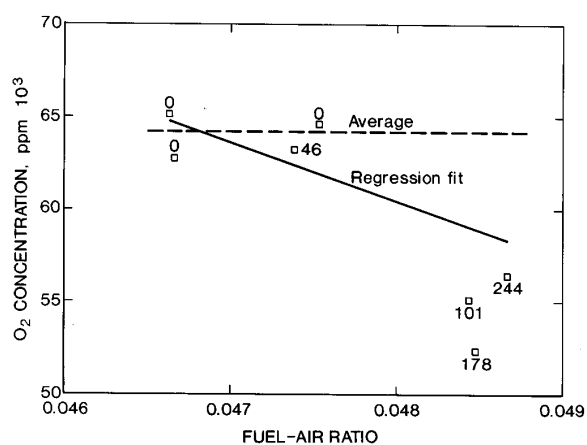

Figure C-1.—Adjustment procedures for fuel-air variations. Data labels are hours of conditioning time.

APPENDIX D.—ENGINE AND EMISSIONS DATA

Table D-1.—General test data

Date	Test series	Fuel		Engine condition time, h	Barometric pressure, mm Hg
		Lot ¹	Additive ²		
11/7/88	MAS001	1	U	0	28.87
11/8/88	MAS002	1	U	0	29.13
11/9/88	MAS101	1	M	0	28.97
11/17/88	MAS102	1	M	46	29.12
11/28/88	MAS103	2	M	101	29.11
12/9/88	MAS104	2	M	178	29.40
12/22/88	MAS105	2	M	244	28.98

M Maintenance.

U Untreated.

¹A fuel change occurred between conditioning times of 46 and 101 h.

²Maintenance concentration is 1,280 parts fuel to 1 part additive; conditioning concentration is 320 parts fuel to 1 part additive.

Table D-2.—Engine load, sample time, and intake conditions

Mode ¹	Torque, ft-lb	Speed, r/min	Time, min	Intake press ratio	Mode ¹	Torque, ft-lb	Speed, r/min	Time, min	Intake press ratio
MAS001:					MAS102 (cont.):				
1	8	733	14.5	0.97	9	135	2,294	NA	0.94
2	8	1,594	14.5	.96	10	90	2,294	14.5	.94
3	52	1,595	14.5	.96	11	45	2,294	NA	.94
4	105	1,595	13.5	.96	12	10	2,293	NA	.94
5	157	1,595	14.5	.96	13	8	732	NA	.98
6	212	1,595	3.5	.96	14	199	1,595	2	.87
7	8	733	14.5	.97	RDC	107	1,522	8	.96
8	183	2,297	5	.94	MAS103:				
9	138	2,293	14.5	.94	1	7	732	14.5	.97
10	92	2,294	12	.94	2	7	1,594	14.5	.95
11	46	2,294	12	.94	3	52	1,595	NA	.95
12	10	2,293	14.5	.94	4	105	1,595	NA	.96
13	8	732	14.5	.98	5	157	1,595	NA	.96
14	201	1,595	2	.87	6	212	1,596	6	.96
RDC	109	1,526	8	.96	7	8	731	NA	.97
MAS002:					8	180	2,297	8	.93
1	8	731	14.5	.98	9	135	2,294	NA	.94
2	8	1,594	14.5	.96	10	90	2,295	14.5	.94
3	52	1,595	14.5	.95	11	45	2,293	NA	.94
4	105	1,595	13.5	.95	12	10	2,293	NA	.94
5	157	1,595	14.5	.95	13	7	732	NA	.98
6	210	1,594	4	.96	14	195	1,596	2	.86
7	7	732	14.5	.97	RDC	106	1,527	8	.94
8	180	2,297	7	.94	MAS104:				
9	135	2,294	14.5	.94	1	7	732	14.5	.96
10	90	2,294	12	.94	2	7	1,594	14.5	.96
11	45	2,294	14.5	.94	3	52	1,595	NA	.96
12	10	2,293	14.5	.94	4	105	1,594	NA	.96
13	8	732	14.5	.98	5	157	1,595	NA	.96
14	198	1,596	2	.87	6	213	1,594	3	.96
RDC	107	1,525	8	.96	7	8	731	NA	1.00
MAS101:					8	185	2,298	8	.94
1	7	731	14.5	.97	9	135	2,295	NA	.94
2	7	1,594	14.5	.96	10	90	2,294	14.5	.94
3	52	1,595	14.5	.96	11	45	2,294	NA	.94
4	105	1,595	14.5	.96	12	10	2,293	NA	.94
5	157	1,595	14.5	.96	13	8	732	NA	.97
6	207	1,595	4.5	.96	14	197	1,595	2	.87
7	8	732	14.5	.97	RDC	108	1,520	8	.96
8	177	2,297	7	.95	MAS105:				
9	135	2,294	14.5	.94	1	7	731	14.5	.97
10	90	2,293	14.5	.94	2	7	1,594	14.5	.96
11	45	2,294	12.5	.94	3	52	1,595	NA	.95
12	10	2,293	14.5	.94	4	105	1,595	NA	.96
13	8	732	14.5	.97	5	157	1,595	NA	.95
14	193	1,596	2	.86	6	212	1,595	3	.96
RDC	107	1,527	8	.96	7	8	731	NA	.97
MAS102:					8	182	2,297	8	.94
1	8	732	14.5	.98	9	135	2,294	NA	.94
2	8	1,594	14.5	.96	10	90	2,294	14.5	.94
3	52	1,595	NA	.96	11	45	2,294	NA	.94
4	105	1,595	NA	.96	12	9	2,293	NA	.94
5	157	1,595	NA	.96	13	7	731	NA	.97
6	211	1,596	9	.96	14	194	1,594	2	.87
7	8	733	NA	.98	RDC	106	1,524	8	.96
8	181	2,297	8	.95					

NA Not available.

RDC Research duty cycle.

¹Data sets MAS001 and MAS002 are for fuel without ferrocene; MAS101, MAS102, MAS103, MAS104, and MAS105 are for fuel with the maintenance concentration of ferrocene.

Table D-3.—Engine conditions

Mode ¹	Fuel rate, lb/h	Power, bhp	Engine volume flow, cfm	Fuel-to-air ratio	Brake specific fuel consumption, lb/hp-h	Exhaust temperature, °F	Mode ¹	Fuel rate, lb/h	Power, bhp	Engine volume flow, cfm	Fuel-to-air ratio	Brake specific fuel consumption, lb/hp-h	Exhaust temperature, °F
MAS001:							MAS102 (cont.):						
1 ...	2.6	1.1	69	0.0084	2.40	178	9 ...	26.9	59.1	190	0.0320	0.45	727
2 ...	6.4	2.3	149	.0097	2.78	240	10 ..	20.4	39.3	196	.0235	.52	561
3 ...	9.8	15.8	144	.0154	.62	338	11 ..	14.8	19.7	203	.0165	.75	426
4 ...	14.2	31.8	139	.0231	.45	471	12 ..	10.7	4.3	207	.0117	2.48	335
5 ...	19.4	47.7	134	.0327	.41	640	13 ..	2.7	1.1	69	.0088	2.48	180
6 ...	26.9	64.3	128	.0475	.42	930	14 ..	27.1	60.4	117	.0523	.45	1,015
7 ...	2.4	1.0	69	.0080	2.38	191	RDC	17.5	36.4	131	.0302	.48	612
8 ...	35.5	80.1	185	.0434	.44	968	MAS103:						
9 ...	26.9	60.2	190	.0320	.45	729	1 ...	2.6	1.0	69	.0084	2.64	186
10 ..	20.3	40.1	196	.0233	.50	559	2 ...	6.4	2.1	148	.0098	2.99	249
11 ..	14.4	20.0	203	.0161	.72	420	3 ...	10.0	15.8	143	.0158	.63	348
12 ..	10.4	4.3	208	.0113	2.40	328	4 ...	14.4	31.7	139	.0236	.45	483
13 ..	2.5	1.1	69	.0083	2.33	178	5 ...	19.7	47.6	133	.0335	.41	652
14 ..	27.8	60.9	117	.0538	.46	1,031	6 ...	27.3	64.5	127	.0484	.42	955
RDC	17.4	37.1	132	.0300	.47	622	7 ...	2.5	1.0	69	.0083	2.54	200
MAS002:							8 ...	35.6	78.6	181	.0444	.45	989
1 ...	2.6	1.0	70	.0084	2.54	176	9 ...	26.8	59.1	191	.0318	.45	743
2 ...	6.2	2.2	148	.0094	2.76	242	10 ..	20.5	39.4	197	.0236	.52	573
3 ...	9.9	15.8	144	.0155	.62	339	11 ..	14.8	19.6	204	.0164	.76	431
4 ...	14.2	31.7	138	.0233	.45	476	12 ..	10.7	4.1	208	.0117	2.61	341
5 ...	19.4	47.6	133	.0330	.41	649	13 ..	2.6	1.0	70	.0084	2.64	184
6 ...	26.5	63.6	129	.0466	.42	920	14 ..	27.9	59.2	118	.0536	.47	1,042
7 ...	2.5	1.0	69	.0081	2.49	193	RDC	17.7	36.0	131	.0307	.49	655
8 ...	35.1	78.9	184	.0431	.45	963	MAS104:						
9 ...	26.5	59.0	190	.0316	.45	724	1 ...	2.8	1.0	69	.0093	2.84	NA
10 ..	20.2	39.3	196	.0233	.51	563	2 ...	6.8	2.2	149	.0104	3.15	NA
11 ..	14.4	19.6	202	.0161	.73	426	3 ...	10.4	15.8	145	.0162	.66	NA
12 ..	10.4	4.1	207	.0113	2.51	334	4 ...	14.8	31.7	140	.0240	.47	NA
13 ..	2.6	1.0	70	.0083	2.56	180	5 ...	20.0	47.6	134	.0337	.42	NA
14 ..	27.3	60.1	117	.0527	.45	1,028	6 ...	27.6	64.5	129	.0485	.43	NA
RDC	17.2	36.3	132	.0294	.47	620	7 ...	2.8	1.0	72	.0089	2.81	NA
MAS101:							8 ...	36.7	80.9	186	.0446	.45	NA
1 ...	2.6	1.0	69	.0085	2.62	185	9 ...	27.1	59.1	193	.0319	.46	NA
2 ...	6.1	2.2	148	.0093	2.80	245	10 ..	20.8	39.4	197	.0239	.53	NA
3 ...	9.8	15.8	144	.0154	.62	343	11 ..	15.0	19.6	204	.0167	.77	NA
4 ...	14.3	31.8	139	.0234	.45	482	12 ..	11.1	4.1	208	.0121	2.68	NA
5 ...	19.5	47.6	133	.0331	.41	659	13 ...	3.1	1.0	68	.0101	3.12	NA
6 ...	26.5	62.9	129	.0467	.42	935	14 ..	28.1	59.8	118	.0539	.47	NA
7 ...	2.4	1.0	69	.0080	2.43	202	RDC	18.1	36.9	133	.0308	.49	NA
8 ...	34.7	77.5	187	.0421	.45	964	MAS105:						
9 ...	26.7	59.1	191	.0317	.45	730	1 ...	2.7	1.0	69	.0088	2.78	183
10 ..	20.2	39.3	197	.0233	.51	563	2 ...	6.2	2.1	148	.0096	2.95	245
11 ..	14.4	19.6	203	.0161	.73	425	3 ...	9.5	15.8	143	.0151	.60	347
12 ..	10.4	4.4	207	.0114	2.39	333	4 ...	14.5	31.7	138	.0238	.46	482
13 ..	2.6	1.1	69	.0087	2.41	180	5 ...	19.9	47.6	133	.0339	.42	654
14 ..	26.1	58.7	117	.0505	.45	978	6 ...	27.4	64.3	127	.0487	.43	965
RDC	17.5	36.5	132	.0301	.48	628	7 ...	2.5	1.0	69	.0081	2.44	203
MAS102:							8 ...	35.6	79.8	184	.0438	.45	997
1 ...	2.7	1.0	70	.0088	2.60	181	9 ...	26.7	59.1	190	.0319	.45	742
2 ...	6.5	2.3	148	.0100	2.84	244	10 ..	20.4	39.4	195	.0237	.52	573
3 ...	10.1	15.8	143	.0159	.64	340	11 ..	14.6	19.7	201	.0164	.74	435
4 ...	14.6	31.7	139	.0238	.46	476	12 ..	10.3	3.7	206	.0114	2.77	339
5 ...	19.7	47.6	133	.0334	.41	643	13 ..	2.5	.9	69	.0081	2.74	184
6 ...	26.8	64.1	128	.0474	.42	922	14 ..	27.0	58.9	117	.0523	.46	988
7 ...	2.5	1.1	69	.0082	2.32	193	RDC	17.3	36.3	132	.0296	.48	625
8 ...	35.7	79.3	186	.0434	.45	958							

NA Not available.

RDC Research duty cycle.

¹Data sets MAS001 and MAS002 are for fuel without ferrocene; MAS101, MAS102, MAS103, MAS104, and MAS105 are for fuel with the conditioning concentration of ferrocene.

Table D-4.—Particulate parameters

Mode ¹	Filter DPM weight, mg	Volatile (VDPM) weight, mg	Exhaust dilution ratio	DPM concentration, mg/m ³	Extinction coefficient, cm ⁻¹	Mode ¹	Filter DPM weight, mg	Volatile (VDPM) weight, mg	Exhaust dilution ratio	DPM concentration, mg/m ³	Extinction coefficient, cm ⁻¹
MAS001:						MAS102 (cont.):					
1	19.7	11.9	20	30	0.09	9	NA	NA	15	NA	0.28
2	64.7	44.4	18	95	.21	10	42.4	5.7	19	68	.26
3	51.0	32.9	19	78	.24	11	NA	NA	15	NA	.22
4	49.9	29.3	19	86	.29	12	NA	NA	15	NA	.21
5	51.2	NA	19	83	.38	13	NA	NA	19	NA	.06
6	46.5	NA	21	339	2.69	14	45.0	35.5	23	637	5.28
7	13.3	7.3	20	21	.08	RDC	27.4	5.5	21	87	.55
8	28.8	NA	18	124	.80	MAS103:					
9	39.8	NA	18	57	.33	1	16.3	9.3	22	28	.05
10	39.6	19	17	68	.31	2	50.8	36.7	21	84	.17
11	47.8	30.4	17	79	.26	3	NA	NA	18	NA	.21
12	58.2	37.6	16	76	.26	4	NA	NA	18	NA	.25
13	15.9	8.2	20	25	.11	5	NA	NA	17	NA	.34
14	67.9	NA	22	909	7.36	6	69.4	2.8	24	344	2.67
RDC	38.1	NA	19	110	.73	7	NA	NA	21	NA	.07
MAS002:						8	40.2	3.3	22	130	.86
1	18.8	NA	21	30	.02	9	NA	NA	16	NA	.32
2	60.0	39.6	20	94	.15	10	44.5	21.7	21	74	.28
3	48.6	30.9	20	80	.18	11	NA	NA	17	NA	.23
4	46.8	27	21	87	.22	12	NA	NA	17	NA	.21
5	52.3	NA	21	93	.36	13	NA	NA	21	NA	.06
6	52.5	NA	22	364	2.65	14	56.9	0	25	867	7.16
7	12.9	6.4	21	21	.02	RDC	36.5	0	23	123	.80
8	39.5	NA	21	139	.76	MAS104:					
9	34.3	NA	20	57	.22	1	17.2	6.4	19	26	.05
10	36.0	16.9	20	70	.20	2	48.4	27.5	19	73	.18
11	47.2	28.7	19	74	.15	3	NA	NA	16	NA	.23
12	53.2	33.3	18	79	.15	4	NA	NA	16	NA	.27
13	14.8	7.5	21	24	.02	5	NA	NA	15	NA	.38
14	56.2	NA	23	804	6.27	6	47.1	1.6	21	399	3.03
RDC	33.3	NA	21	105	.59	7	NA	NA	18	NA	.06
MAS101:						8	44.2	3.7	20	132	.89
1	20.4	13.6	20	32	.03	9	NA	NA	14	NA	.30
2	59.5	40.9	19	90	.15	10	33.0	11	19	51	.27
3	45.4	NA	19	73	.17	11	NA	NA	13	NA	.23
4	47.4	NA	20	80	.23	12	NA	NA	15	NA	.22
5	50.7	18.5	21	88	.36	13	NA	NA	18	NA	.08
6	60.0	0	22	373	2.89	14	62.5	0	22	833	8.20
7	14.2	7.3	20	23	.05	RDC	36.0	0	20	110	.79
8	35.6	4.6	20	123	.72	MAS105:					
9	37.2	10.1	19	60	.28	1	14.0	5.2	19	20	.01
10	42.3	18.6	19	66	.23	2	37.5	19.3	18	54	.12
11	50.2	31.9	18	88	.20	3	NA	NA	16	NA	.14
12	60.1	39.8	18	85	.19	4	NA	NA	15	NA	.19
13	17.9	10.5	20	28	.06	5	NA	NA	15	NA	.31
14	42.6	0	22	549	4.38	6	41.5	.4	20	380	2.99
RDC	41.1	.4	21	125	.76	7	NA	NA	18	NA	.04
MAS102:						8	42.5	1.4	19	122	.82
1	26.2	3.9	20	42	.06	9	NA	NA	14	NA	.25
2	54.7	-2	19	87	.20	10	32.9	8.7	18	49	.20
3	NA	NA	17	NA	.23	11	NA	NA	15	NA	.13
4	NA	NA	17	NA	.29	12	NA	NA	15	NA	.10
5	NA	NA	15	NA	.36	13	NA	NA	18	NA	-.01
6	97.5	20	22	341	2.39	14	35.1	NA	21	440	4.26
7	NA	NA	19	NA	.06	RDC	24.8	1	20	72	.41
8	40.3	4.1	20	126	.85						

NA Not available.

RDC Research duty cycle.

¹Data sets MAS001 and MAS002 are for fuel without ferrocene; MAS101, MAS102, MAS103, MAS104, and MAS105 are for fuel with the conditioning concentration of ferrocene.

Table D-5.—Gas-phase emissions, parts per million

Mode ¹	HC	NO _x	CO	CO ₂	O ₂	Mode ¹	HC	NO _x	CO	CO ₂	O ₂
MAS001:						MAS102 (cont.):					
1	59	290	240	19,800	188,000	9	56	560	140	71,300	113,000
2	104	210	360	22,400	177,000	10	75	400	170	54,000	138,000
3	85	340	190	35,600	157,000	11	72	270	230	37,500	162,000
4	83	540	150	53,200	136,000	12	99	170	340	26,600	178,000
5	78	720	140	74,000	110,000	13	60	300	210	19,300	189,000
6	78	680	350	106,200	65,000	14	70	670	900	120,000	45,000
7	65	260	210	18,500	193,000	RDC	46	500	150	55,100	129,000
8	65	570	210	98,500	77,000	MAS103:					
9	76	510	160	72,200	115,000	1	71	340	250	20,900	183,000
10	83	370	170	52,900	142,000	2	122	240	380	24,000	179,000
11	82	250	230	36,900	162,000	3	87	350	190	35,700	161,000
12	100	160	320	26,100	173,000	4	69	530	140	52,600	135,000
13	65	290	240	19,600	179,000	5	57	720	130	72,200	108,000
14	327	620	1,350	121,500	42,000	6	76	720	400	109,400	55,000
RDC	71	40	180	54,100	126,000	7	57	310	200	18,900	187,000
MAS002:						8	54	630	240	100,800	68,000
1	54	300	230	19,800	186,000	9	58	520	160	72,000	108,000
2	94	220	330	22,700	183,000	10	76	400	180	54,000	134,000
3	79	350	180	36,400	163,000	11	79	270	240	37,600	157,000
4	77	530	150	53,900	138,000	12	108	170	360	26,500	174,000
5	75	710	150	75,800	108,000	13	75	310	240	19,400	185,000
6	77	710	380	106,600	65,000	14	104	640	1,460	121,000	36,000
7	52	280	200	19,000	187,000	RDC	42	480	210	56,600	119,000
8	62	610	220	98,700	76,000	MAS104:					
9	70	520	160	71,700	111,000	1	59	320	NA	21,300	179,000
10	81	0	170	53,500	138,000	2	132	240	NA	24,200	174,000
11	82	240	230	37,700	161,000	3	99	330	NA	36,100	156,000
12	101	160	320	26,700	176,000	4	85	510	NA	54,200	131,000
13	59	310	220	19,800	186,000	5	65	710	NA	75,100	102,000
14	82	640	1,160	121,200	46,000	6	69	710	NA	112,500	52,000
RDC	59	460	170	53,300	127,000	7	53	290	NA	19,100	177,000
MAS101:						8	53	680	NA	103,800	65,000
1	62	290	230	19,900	185,000	9	57	570	NA	73,600	102,000
2	96	220	320	22,500	182,000	10	68	420	NA	55,700	126,000
3	80	340	170	35,700	162,000	11	73	250	NA	33,600	131,000
4	76	530	140	53,400	137,000	12	119	180	NA	27,700	163,000
5	82	730	140	75,100	107,000	13	81	290	NA	20,800	172,000
6	90	710	370	104,800	63,000	14	71	630	NA	125,600	33,000
7	68	270	190	19,000	187,000	RDC	48	500	NA	58,100	111,000
8	67	560	210	95,500	77,000	MAS105:					
9	74	490	160	71,600	110,000	1	54	370	250	21,800	182,000
10	91	350	190	52,900	137,000	2	100	260	350	24,200	178,000
11	102	240	260	37,500	160,000	3	87	400	180	37,000	159,000
12	113	160	340	26,600	176,000	4	71	600	140	53,700	136,000
13	66	300	220	20,200	186,000	5	72	830	140	75,400	107,000
14	73	660	740	118,300	52,000	6	84	810	420	113,400	56,000
RDC	57	470	200	54,700	126,000	7	55	310	200	19,600	184,000
MAS102:						8	56	680	210	103,900	70,000
1	64	280	230	20,000	187,000	9	57	570	130	73,400	109,000
2	102	220	340	23,200	182,000	10	62	440	150	55,500	132,000
3	75	330	180	35,100	164,000	11	78	280	230	38,800	155,000
4	67	500	150	51,700	141,000	12	117	180	350	27,000	172,000
5	59	710	130	71,700	112,000	13	66	320	230	20,500	181,000
6	65	750	320	107,300	63,000	14	95	680	620	119,000	43,000
7	49	290	170	18,500	190,000	RDC	50	510	NA	56,900	121,000
8	52	650	200	98,000	75,000						

NA Not available.

RDC Research duty cycle.

¹Data sets MAS001 and MAS002 are for fuel without ferrocene; MAS101, MAS102, MAS103, MAS104, and MAS105 are for fuel with the conditioning concentration of ferrocene.